



**EGLO**  
my light | my style



**2022/23**

# **INTERIOR LIGHTING**

WOHNRAUMLEUCHTEN  
LUMINAIRES INTÉRIEURS







Dear business partners and faithful friends of EGLO,

We are proud to present our new luminaire highlights, inspired by the latest trends and styles of the 2022/23 season. Sustainability, with a focus on protecting the planet and its resources, is still very much in demand. Protecting the environment while at the same time creating a future for many generations to come has become part of a global commitment. The call for freedom, humility, a return to nature, and security is louder than ever, especially in these times of crisis. It is more important than ever to be able to feel secure and at ease in your own home. Our Boho, Wabi Sabi and New Nordic Style fittings are designed to meet this need. All these home decorating trends combine simplicity, warm colours and harmony. The calm, minimalist styles of the season, with their occasional rough edges, are enhanced by rich metallic tones in brass and bronze, creating small eye-catching highlights in your living room. Be inspired and explore this year's world of EGLO lighting trends.

I hope you enjoy browsing our new main catalogue.

Geschätzte Geschäftspartner\*innen, treue EGLO Freund\*innen,

Freuen sie sich auf unsere Leuchten-Highlights, angelehnt an die aktuellen Trends und Styles der Saison 2022/23. Nach wie vor sind Trends im Sinne der Nachhaltigkeit gefragt, diese bauen auf dem Schutz unseres Planeten und seiner Ressourcen auf. Es ist Teil einer globalen Verpflichtung geworden, die Umwelt zu schützen und gleichzeitig eine Zukunft für viele kommende Generationen zu schaffen. Gerade in den aktuellen Krisenzeiten ist der Ruf nach Freiheit, Demut und Natürlichkeit sowie Sicherheit lauter denn je. Umso wichtiger ist es, sich in seinen eigenen 4 Wänden geborgen und zu Hause zu fühlen. Mit Einrichtungen im Boho, Wabi Sabi oder New Nordic Style wird diesem Bedürfnis Rechnung getragen. All diese Wohntrends verbinden Einfachheit, warme Farbwelten und Harmonie miteinander. Die ruhigen und minimalistischen, manchmal auch unvollkommenen Styles der Saison, werden mit wertigen Metalltönen in Messing und Bronze abgerundet und kreieren kleine Eyecatcher im Wohnraum. Lassen Sie sich inspirieren und tauchen Sie ein in die Welt der EGLO Leuchten-Trends des Jahres.

Ich wünsche Ihnen viel Freude beim Durchschauen des neuen Hauptkatalogs.

Chers partenaires, chers amis d'EGLO,

Découvrez nos produits phares inspirés des tendances et styles actuels de la saison 2022/23. Cette fois encore, les tendances recherchées sont associées au développement durable, car elles favorisent la protection de notre planète et de ses ressources. Dans le monde entier, on s'est fixé le devoir de protéger l'environnement tout en créant un avenir pour les générations futures. En raison des périodes de crise que nous traversons actuellement, nous recherchons plus que jamais la liberté, l'humilité, la nature et la sécurité. Il est donc d'autant plus important de se sentir à l'aise et bien à l'abri chez soi. Un aménagement dans le style Boho, Wabi Sabi ou New Nordic permet de répondre à ce besoin. Tous ces styles allient simplicité et harmonie à un univers de couleurs chaleureuses. Les styles paisibles et minimalistes, voire imparfaits de cette saison sont complétés par des tons métalliques de qualité en laiton et en bronze pour attirer tous les regards. Laissez-vous inspirer et plongez dans le monde des tendances d'éclairage EGLO de l'année.

Je vous souhaite beaucoup de plaisir à consulter le nouveau catalogue.

  
Mag. René Tiefenbacher  
CEO EGLO Group

# CONTENT

INHALT  
CONTENU



## EGLO CONNECT

P.010 - 097



## EGLO ACCESS

P.098 - 113



## LIGHTING FAMILIES

### FABRIC LUMINAIRES

STOFFLEUCHTEN  
LUMINAIRES À TEXTIL

P.114 - 191



## LIGHTING FAMILIES

### WOOD LUMINAIRES

HOLZLEUCHTEN  
LUMINAIRES À BOIS

P.192 - 211



## LIGHTING FAMILIES

### STANDARD LUMINAIRES

STANDARD LEUCHTEN  
LUMINAIRES STANDARD

P.212 - 315



## LIGHTING FAMILIES

### GLASS CHANDELIERS

LEUCHTENFAMILIEN  
FAMILIES DE LUMINAIRES

P.316 - 325



## HANGING & PENDANT LUMINAIRES

HÄNGE- & PENDELLEUCHTEN  
LUMINAIRES SUSPENSIONS

P.326 - 447





## WALL & CEILING LUMINAIRES

WAND- & DECKENLEUCHTEN  
APPLIQUES & PLAFONNIERS

**P.448 - 595**



## BATH & MIRROR LUMINAIRES

BAD- & SPIEGELLEUCHTEN  
LUMINAIRES DE BAIN & MIROIR

**P.596 - 655**



## SPOTS & TRACK LUMINAIRES

SPOTS- & SCHIENENLEUCHTEN  
SPOTS & LUMINAIRES SUR RAIL

**P.656 - 749**



## CLIP & PLUG LUMINAIRES

KLEMM- & STECKERLEUCHTEN  
LUMINAIRES À PINCE & SUR PRISE

**P.750 - 755**



## TABLE & FLOOR LUMINAIRES

TISCH- & STEHLEUCHTEN  
LUMINAIRES DE TABLE & LAMPADAIRES

**P.756 - 797**



## OFFICE TABLE & FLOOR LUMINAIRES

OFFICE TISCH- & STEHLEUCHTEN  
LUMINAIRES DE TABLE & LAMPADAIRES À BUREAU

**P.798 - 831**



## CHILDREN LUMINAIRES

KINDERLEUCHTEN  
LUMINAIRES POUR ENFANTS

**P.832 - 837**



## KITCHEN & FUNCTION LUMINAIRES

KÜCHEN- & FUNKTIONSLEUCHTEN  
LUMINAIRES FONCTIONNELS & DE CUISINE

**P.838 - 843**



## ACCESSORIES

ZUBEHÖR  
ACCESSOIRES

**P.844 - 847**



## INDEX & LEGEND

INDEX & ERKLÄRUNG  
INDEX & LÉGENDE

**P.848 - 872**



# EGLO TREND HIGHLIGHTS

2022/23



The EGLO design team has once again drawn on current mega-trends as a source of inspiration for the 2022/23 season. The new EGLO products' use of shape and colour, choice of materials, and overall aesthetic harmonise perfectly with both contemporary and future living trends. Minimalism and the increasingly popular use of materials and colours such as brass and earth tones have had a particularly strong influence on this season's luminaire designs.

Auf Basis der Megatrends hat sich das Design-Team von EGLO auch für die Saison 2022/23 inspirieren lassen. Mit ihrer Formsprache, Farbgebung sowie den verwendeten Materialien fügen sich die EGLO Neuheiten in die aktuellen wie auch zukünftigen Wohntrends ein. Der Trend des Minimalismus sowie die Verwendung von Materialien und Farben wie Messing und Erdtöne haben auf die aktuellen Leuchten-Designs besonderen Einfluss genommen.

Sur la base des mégatendances, l'équipe de conception EGLO a également été inspirée pour la saison 2022/23. Avec leur langage visuel, leur palette de couleurs et les matériaux utilisés, les innovations EGLO s'intègrent dans les tendances de la vie d'aujourd'hui et de demain. La tendance au minimalisme et l'utilisation de matériaux et de couleurs tels que le laiton et les tons de terre ont eu une influence particulière sur les conceptions actuelles de nos luminaires.

**Minimalism** - The art of less, the conscious reduction of shapes and colours to the bare essentials, is reflected in our luminaires. Clear and simple shapes and plain colours combine to create a calm atmosphere, in keeping with the maxim "less is more". Warm grey tones and timber elements give the room a welcoming touch, adding atmospheric highlights and offering a harmonious stage for your entire living space to work its magic without any distractions.

**Minimalismus** - Der bewusste Verzicht und die Kunst, Form und Farbe auf ein Minimum zu reduzieren, spiegelt sich in unseren Leuchten wider. Frei nach dem Prinzip „Weniger ist mehr“ sorgen klare und einfache Formen sowie schlichte Farben für eine ruhige Atmosphäre. Für die nötige Gemütlichkeit setzen warme Grautöne oder Holzelemente stimmungsvolle Akzente und bieten eine harmonische Bühne, um den gesamten Raum ganz ohne Ablenkung für sich wirken zu lassen.

**Le minimalisme** - Nos lampes reflètent un renoncement volontaire et l'art de réduire au minimum formes et couleurs. Selon le principe « faire plus avec moins », des formes claires et simples et des couleurs unies créent une atmosphère paisible. Pour le confort, des tons gris chauds ou des éléments en bois mettent en place une ambiance agréable et un décor harmonieux pour vous permettre de travailler dans une pièce sans aucune distraction.





ONEDA







## MANZANARES

**Brass** - Brass so popular back in the 50s and 60s, is currently enjoying a new wave of popularity. Skilfully paired with contrasting materials, the gleaming metallic hues of brass bring a touch of luxury to living spaces without appearing old-fashioned. We have incorporated the high-quality material into our new luminaire models and combined it with diverse other materials to create captivating modern designs that can be integrated into a variety of interiors, from urban to classical to minimalist.

**Messing** - Der bereits in den 50er und 60er Jahren so populäre Messingtrend erfreut sich aktuell an neuer Beliebtheit. Gekonnt kombiniert und kontrastreich in Szene gesetzt, bringt Messing mit seinem strahlenden Metallton einen Hauch von Luxus in die Wohnräume, ohne altmodisch zu wirken. Das hochwertige Material haben wir in unsere neuen Leuchten-Modelle einfließen lassen und in Kombination mit verschiedenen Materialien charmante und moderne Designs geschaffen, die sich in unterschiedliche Einrichtungen von urban über klassisch bis hin zu minimalistisch integrieren lassen.

**Le laitton** - La tendance du laitton, déjà si populaire dans les années 50 et 60, est actuellement à nouveau au goût du jour. Habilement combiné et mis en scène avec de riches contrastes, le laitton avec sa teinte métallique brillante apporte une touche de luxe aux espaces de vie sans paraître démodé. Nous avons incorporé ce matériau de haute qualité dans nos nouveaux modèles de luminaires et, en combinaison avec divers matériaux, avons créé des designs charmants et modernes qui peuvent être intégrés à des aménagements différents, qu'ils soient notamment urbains, classiques ou encore minimalistes.

**Warm earth tones** - The very popular back-to-nature trend has also brought about a significant shift in the field of design. More and more people have been embracing a return to nature in recent years and the associated use of natural materials has also left its mark on the world of colour, heralding the rise of brown as the new black. The colour brown in all its many facets can be beautifully paired with almost any other colour and, thanks to its diverse earthy tones, not only lends our living spaces a touch of naturalness, but also conveys a sense of warmth and comfort. Combining this year's popular colour trend with wood and brass elements helps accentuate its distinctive appeal.

**Warme Erdtöne** - Der starke Trend hin zu mehr Natürlichkeit hat auch im Design einen bedeutsamen Wandel bewirkt. Die in den letzten Jahren deutlich an Bedeutung gewonnene Verbundenheit zur Natur und die damit einhergehende Verwendung von natürlichen Materialien hat auch die Farbwelt geprägt und lässt Braun als das neue Schwarz triumphieren. Braun in all seinen Facetten lässt sich hervorragend kombinieren und verleiht unseren Wohnräumen durch seine vielfältigen Erdtöne nicht nur einen Hauch von Natürlichkeit, sondern vermittelt Gemütlichkeit und Behaglichkeit gleichermaßen. Die Kombination mit Holz oder Messing verleiht der neuen Trendfarbe ihre besonderen Akzente.

**Des tons chauds de terre** - La forte tendance vers un caractère plus naturel a également entraîné un changement significatif dans notre conception. Le lien avec la nature, qui a grandement gagné en importance ces dernières années, et l'utilisation associée de matériaux naturels ont également façonné l'univers des couleurs : c'est ainsi que le brun a détrôné le noir. Le brun sous toutes ses facettes peut être parfaitement combiné et, avec ses divers tons de terre, non seulement donner à nos salons une touche naturelle, mais aussi procurer confort et bien-être dans le même temps. La combinaison de cette nouvelle couleur tendance avec le bois ou le laiton lui confère ses accents si particuliers.



VALDIOLA



# Look out for this Logo!

Achten Sie auf das Logo!

Soyez attentif au logo !

## What is a forest?

A peaceful oasis, the green lungs of the world, and an adventure playground for children of all ages!

The Forest Stewardship Council® (FSC®) is a global, not-for-profit organisation dedicated to the promotion of responsible forest management worldwide. The FSC® defines standards for responsible forest management in accordance with established principles that are developed and supported by stakeholders from the environmental, social and economic spheres. For more information, please see [www.fsc.org](http://www.fsc.org).

## Was ist Wald für uns?

Eine Oase der Ruhe, die Lunge der Welt oder ein Abenteuerspielplatz für große und kleine Kinder!

Das Forest Stewardship Council® (FSC®) ist eine globale, gemeinnützige Organisation, mit dem Zweck verantwortungsvolle Waldbewirtschaftung weltweit zu fördern. FSC® definiert Standards für eine verantwortungsvolle Waldbewirtschaftung nach festgelegten Prinzipien, die von Interessenvertretern aus den Bereichen Umwelt, Soziales und Wirtschaft entwickelt und getragen werden. Für weitere Informationen besuchen Sie [www.fsc.org](http://www.fsc.org).

## Que représente la forêt pour nous ?

Une oasis de calme, les poumons du monde ou un terrain de jeu d'aventure pour les enfants de tous âges !

Le Forest Stewardship Council® (FSC®) est une organisation internationale à but non lucratif dont le but est de promouvoir une gestion forestière responsable dans le monde entier. Le FSC® définit des normes de gestion forestière responsable selon des principes établis qui sont développés et soutenus par les parties prenantes des secteurs environnemental, social et économique. Pour plus d'informations, veuillez consulter [www.fsc.org](http://www.fsc.org).

Look out for FSC® -certified products!  
Achten Sie auf FSC® -zertifizierte Produkte!  
Soyez attentif aux produits certifiés FSC® !



The mark of  
responsible forestry



# DIGITAL CATALOGUE

This year, we are also making the main catalogue in front of you available online, including lots of extra information and additional features. In addition to search and filter functions, the online catalogue includes extensive product photos, videos and additional information, complementing the paper edition wonderfully. Take a look at <https://catalogue.eglo.com>

In diesem Jahr präsentieren wir den vor Ihnen liegenden Hauptkatalog wieder als Online-Katalog mit vielen Zusatzinformationen und zusätzlichen Features. Neben Such- und Filterfunktionen bietet der Online-Katalog mit reichhaltigen Produktabbildungen, Videos und zusätzlichen Informationen einen erheblichen Mehrwert zur gebundenen Ausgabe. Klicken Sie sich rein unter <https://catalogue.eglo.com>

Cette année, nous présentons à nouveau une version en ligne du catalogue général. Cette version contient de nombreuses informations et fonctionnalités complémentaires. Outre les fonctionnalités de recherche et de filtrage, le catalogue en ligne propose de nombreuses illustrations de produits, des vidéos et des informations complémentaires : une valeur ajoutée considérable par rapport à la version papier. Cliquez ici pour le découvrir : <https://catalogue.eglo.com>



99795





# connect.2

 **zigbee**  **Bluetooth®**











































# Discover the smart world





# OVERVIEW

EGLO CONNECT.Z

 CONNECT-Z SENSOR p. 21	 CONNECT Z p. 21	 ANCHORENA-Z p. 22-23	 SALVILANAS-Z p. 24-25	 LOBINERO-Z p. 26	 ZILLERIO-Z p. 26	 ANDABAIA-Z p. 27	 TELIMBELA-Z p. 28-29
 TOLLOS-Z p. 30	 ROMAO-Z p. 30-31	 MONTEMORELOS-Z p. 32-33	 TOTARI-Z p. 33	 GENOVESE-Z p. 33	 PARRAPOS-Z p. 34-35	 PARANDAY-Z p. 36-37	 CALAGRANO-Z p. 37
 PADROGIANO-Z p. 38-40	 VALDELAGRANO-Z p. 42	 SIMOLARIS-Z p. 42-43	 MARGHERA-Z p. 44-45	 CAMINALES-Z p. 46	 SALICETO-Z p. 47	 LOMALTAS-Z p. 48	 TABIANO-Z p. 49
 JUAREZA-Z p. 49	 FRAIOLI-Z p. 50-51	 TOTARI-Z p. 52-53	 LANCIANO-Z p. 54	 CAPASSO-Z p. 55	 SILERAS-Z p. 55	 SAVATARILA-Z p. 56-57	 SALITERAS-Z p. 57
 TURCONA-Z p. 58, 62-63	 HERRORA-Z p. 60	 SALOBRENA-Z p. 64-67	 FUEVA-Z p. 68-79	 ROVITO-Z p. 80-83	 LED STRIPE-Z p. 84-85	 LM_LED_E27 p. 86-97	 LM_LED_GU10 p. 87
 LM_LED_E14 p. 87							



This product is available in different colors and shapes./ Dieser Artikel ist in unterschiedlichen Farben und Formen verfügbar.  
Cet article est disponible en différentes couleurs et formes.



## connect.z combines two control technologies in one system

connect.z vereint zwei Steuerungstechnologien in einem System

connect.z réunit deux technologies de commande au sein d'un même système



ZigBee is far and away the most widely used standard in the smart home world.

ZigBee ist der am weitesten verbreitete Standard in der Smart Home Welt.

ZigBee est le protocole le plus répandu au monde dans le domaine du Smart Home.

### ADVANTAGES :

- › Mesh network
- › Direct connection with Amazon Echo and Google Home
- › Compatible with products from different manufacturers
- › High level of security
- › Easy setup
- › Energy efficient

### VORTEILE:

- › Mesh-Netzwerk
- › Direkte Verbindung mit Amazon Echo und Google Home
- › Herstellerübergreifend kompatibel
- › Hohe Sicherheit
- › Einfache Einrichtung
- › Energieeffizient

### AVANTAGES:

- › Réseau maillé
- › Connexion directe à Amazon Echo et Google Home
- › Compatible indépendamment du fabricant
- › Sécurité élevée
- › Installation facile
- › Économe en énergie



# connect.2



Bluetooth is an established standard in the digital world.  
Bluetooth ist ein etablierter Standard in der digitalen Welt.  
Bluetooth est un standard de communication reconnu dans le monde numérique.

#### ADVANTAGES:

- › Local & secure network
- › Protocol is mainly audio (low debit)
- › Mesh network: Elements are receivers and senders
- › Easy setup
- › Usable offline
- › Energy efficient

#### VORTEILE:

- › Lokales & sicheres Netzwerk Protokoll hauptsächlich Audio (Low Debit)
- › Mesh-Netzwerk: Elemente sind Empfänger und Sender
- › Einfache Einrichtung
- › Offline nutzbar
- › Energieeffizient

#### AVANTAGES:

- › Réseau local et sûr
- › Protocole essentiellement audio (bas débit)
- › Réseau maillé : les éléments sont l'émetteur et le récepteur
- › Installation facile
- › Utilisable hors-ligne
- › Économe en énergie

# Light up your world!

Bringen Sie Licht in Ihren Alltag!  
Illuminez votre quotidien !



connect.z offers a wide range of lamps and lighting equipment. Select products from the following options according to your needs:  
connect.z bietet ein großes Sortiment an Leuchten und Leuchtmitteln. Wählen Sie die Produkte ganz nach Ihren Bedürfnissen aus folgenden Varianten:  
connect.z propose une large gamme de luminaires et d'ampoules. Sélectionnez les produits en fonction de vos besoins parmi les variantes suivantes :

**Warm White**

**Neutral White**

**Tunable White**

Individual light from 50,000 white tones.  
Individuelles Licht aus 50.000 Weißtönen.  
Luminaire individuel à 50 000 tons de blanc.

**TW + RGB Colors**

Diverse lighting selection from 50,000 white tones and 16 million colours.  
Vielseitige Lichtauswahl aus 50.000 Weißtönen und 16 Mio. Farben.  
Sélection étendue de luminaires à 50 000 tons de blanc et 16 millions de couleurs.

Enjoy relaxing moments!  
Genießen Sie entspannte Momente!  
Profitez de moments de détente !

Stay focussed & efficient!  
Bleiben Sie konzentriert & leistungsfähig!  
Restez concentré(e) et performant(e) !

Start the day fresh every morning!  
Starten Sie jeden Morgen frisch in den Tag!  
Commencez la journée du bon pied !

Create the perfect atmosphere!  
Kreieren Sie Ihr perfektes Ambiente!  
Créez votre ambiance parfaite !





## Enjoy many useful convenience features:

Es erwarten Sie viele nützliche Komfortfunktionen:  
De nombreuses fonctionnalités utiles vous attendent pour votre confort :



### TIMERS AND CALENDARS / TIMER UND ZEITPLÄNE/ MINUTERIE ET CALENDRIER

Make your daily life easier with timers and calendars.  
Wake up relaxed with the simulated sunrise.

Unterstützen Sie Ihren Alltag mit Timern und Zeitplänen. Entwickeln Sie eigene Lichtroutinen und machen Sie Ihr Leben leichter.

Facilitez-vous la vie à l'aide de la fonction minuterie et calendrier.  
Réveillez-vous en douceur grâce au simulateur de lever de soleil



### LIGHT ALARM CLOCK / LICHTWECKER/ REVEIL LUMINEUX

You'd rather not start your day in a bad mood? Wake up relaxed with the simulated sunrise.

Keine Lust mit schlechter Laune in den Tag zu starten? Entspannt aufwachen mit dem simulierten Sonnenaufgang.

Pas envie de commencer la journée de mauvaise humeur ? Réveillez-vous en douceur grâce au simulateur de lever de soleil.



### DISCO FUNCTION/MODE / DISCOFUNKTION/MODUS/ FONCTION/MODE DISCO

For the perfect party mood, the disco function synchronises the light to the beat of your favourite songs.

Für die perfekte Partystimmung schaltet die Discofunktion das Licht passend zum Beat Ihres Lieblingssongs.

Pour une ambiance festive parfaite, la fonction disco enclenche le luminaire au rythme de votre chanson préférée.



### PRESENCE SIMULATOR / ANWESENHEITSSIMULATION/ SIMULATEUR DE PRESENCE

Protect your home with the convenient presence simulator. Variable time intervals allow the system to turn the lights on and off to simulate your presence at home and deter unwanted guests.

Schütze Sie Ihr Zuhause mit der komfortablen Anwesenheitssimulation. Dank variabler Zeitintervalle simuliert das System durch Ein- und Ausschalten der Beleuchtung die Anwesenheit im Haus und schreckt so ungebetene Gäste ab.

Protégez votre domicile à l'aide du très pratique simulateur de présence. Le système simule votre présence en allumant et en éteignant les lumières à intervalles variables et décourage ainsi les invités indésirables.



### VOICE COMMANDS / SPRACHSTEUERUNG/COMMANDE VOCALE

More convenient! Turn the light on whenever you want with only a voice command.

Noch komfortabler! Mit nur einem Sprachbefehl schaltet sich das Licht nach Ihren Wünschen an und aus.

C'est encore plus confortable ! Allumez votre luminaire comme vous le souhaitez d'une simple commande vocale.

## Control options

Steuerungsmöglichkeiten  
Possibilités de commande



Set your smart home as you prefer! With the app, voice commands, or remote control.

Steuern Sie Ihr Smart Home wie Sie es möchten! Via App, Sprachsteuerung oder mit der Fernbedienung.

Commandez votre Smart Home comme vous le souhaitez ! Via l'appli, la commande vocale ou la télécommande.



### APP CONTROL

Use the free app for smartphone, tablet, or smartwatch.

Nutzen Sie die kostenlose App für das Smartphone, Tablet oder die Smartwatch.

Utilisez l'appli gratuite sur votre smartphone, votre tablette ou votre montre connectée.



### VOICE COMMANDS

Use intelligent voice assistants such as Google Home and Amazon Alexa.

Nutzen Sie intelligente Sprachassistenten wie Google Home und Amazon Alexa.

Utilisez des assistants vocaux intelligents comme Google Home ou Amazon Alexa.



### REMOTE CONTROL

Use the practical remote connect.z operation at any time.

Nutzen Sie auch jederzeit die praktische connect.z Fernbedienung.

Vous pouvez aussi utiliser à tout moment la télécommande connect.z.



### CONNECT.Z ACCESSORIES

Use clever accessories such as the movement sensor and much more.

Nutzen Sie cleveres Zubehör wie z.B. den Bewegungssensor uvm.

Utilisez des accessoires malins tels que le capteur de mouvement et bien d'autres encore.



### DIMMER FUNCTION

Use the practical dimmer function via app, speech command or remote control.

Nutzen Sie die praktische Dimmfunktion via App, Sprachbefehl oder Fernbedienung.

Utilisez la fonction de gradation via l'appli, la commande vocale ou la télécommande.



# One system, many possibilities!

Ein System – viele Möglichkeiten!  
Un système, de nombreuses possibilités!

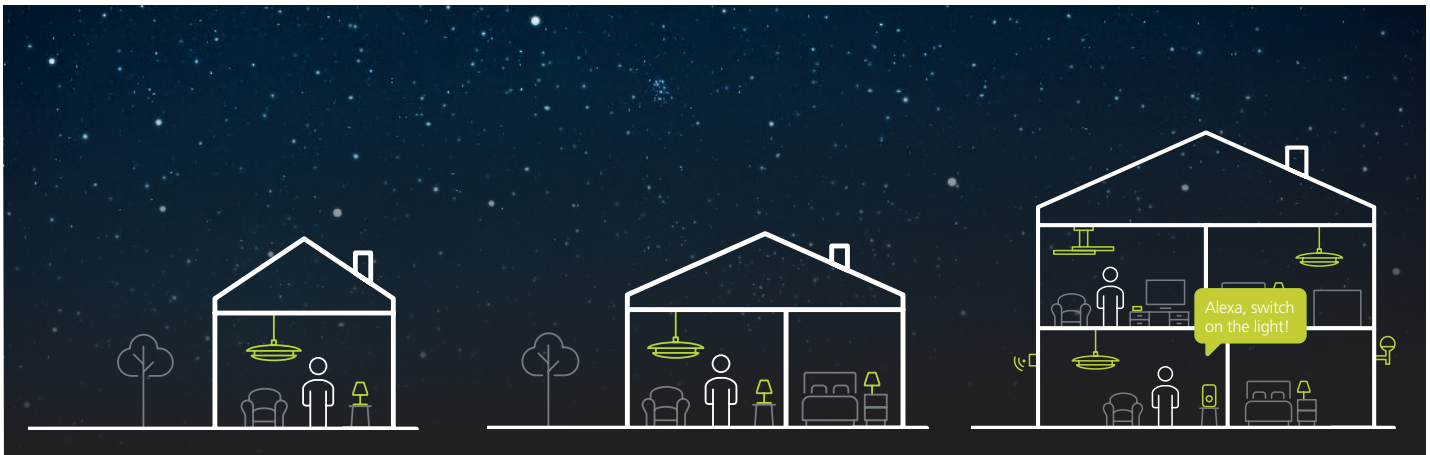

No matter how you start, you can integrate new products into your connect.z system at any time and gradually expand your smart home.  
Egal wie Sie starten, Sie können jederzeit neue Produkte in Ihr connect.z System integrieren und Ihr smartes Zuhause nach und nach erweitern.  
Quel que soit votre choix, vous pouvez à tout moment intégrer de nouveaux produits à votre système connect.z et améliorer progressivement votre maison intelligente.



**BASIC USER**

All you need to start is a connect.z product and the remote control. No internet connection is required and you have access to:

Sie benötigen zum Start lediglich ein connect.z Produkt und die Fernbedienung. Es wird kein Internetzugang benötigt und Sie haben Zugriff auf:

Pour démarrer, il vous suffit d'un produit connect.z et de la télécommande. Aucune connexion Internet n'est nécessaire. Vous avez accès aux :

#### Standard functions:

#### Standardfunktionen:

#### Fonctionnalités standard :

- › Select colour/ Farbauswahl/ sélection de couleur
- › Change colour/ Farbwechsel/ changement decouleur
- › Dim/ Dimmen/ gradation
- › Favourites (2x)/ Favoriten (2x)/ favoris (2x)
- › Groups (3x)/ Gruppen (3x)/ groupes (3x)
- › Candle mode/ Kerzenmodus/ mode bougie

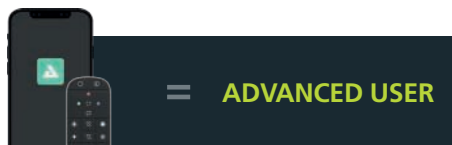

**ADVANCED USER**

Besides the standard functions, would you also like access to the practical convenience features? Then you need only your smartphone or tablet and the Awox app. This app allows you to control your lights via Bluetooth®.

Sie möchten zu den Standardfunktionen auch noch Zugriff auf die praktischen Komfortfunktionen haben? Dann benötigen Sie nur Ihr Smartphone oder Tablet und die Awox App. Mit der App haben Sie die Möglichkeit, Ihre Leuchten über Bluetooth® zu steuern.

Outre les options standard, vous souhaitez également pouvoir utiliser les fonctionnalités de confort les plus pratiques ? Pour cela, vous avez seulement besoin de votre smartphone ou de votre tablette et de l'appli Awox. L'appli vous permet de commander vos luminaires via Bluetooth®.

#### Standard functions + convenience features/ Standardfunktionen + Komfortfunktionen / Fonctionnalités standard + confort

- › Light alarm clock/ Lichtwecker/ réveil lumineux
- › Presence simulation/ Anwesenheitssimulation/ simulateur de présence
- › Disco function/ Discofunktion/ fonction disco
- › Timers & timetables /Timer & Zeitpläne/ minuteur et calendrier
- › Accessories can be incorporated/ Einbindung von Zubehör möglich/ connexion d'accessoires possible



**POWER USER**

Use the system's full potential and control your smart home through the Awox app using WIFI or Bluetooth® as well as integrating a voice assistant into the system. This gives you:

Nutzen Sie das volle Potenzial des Systems und steuern Sie Ihr Smart Home über die Awox App mithilfe von WLAN oder Bluetooth® und integrieren Sie zusätzlich noch einen Sprachassistenten in das System. So mit erhalten Sie:

Exploitez tout le potentiel du système en commandant votre Smart Home grâce à l'appli Awox via le réseau Wi-Fi ou Bluetooth®, et intégrez également un assistant vocal au système. Vous obtenez ainsi :

#### Standard functions + convenience features + voice commands\*

#### Standardfunktionen + Komfortfunktionen + Sprachsteuerung\*

#### Fonctionnalités standard + confort + commande vocale\*

- › Amazon Alexa or Google Home/ Amazon Alexa oder Google Home/ Amazon Alexa ou Google Home

- \* Use a voice assistant with integrated bridge.
- \* Nutzen Sie einen Sprachassistenten mit integrierter Bridge.
- \* Utilisez un assistant vocal avec Bridge intégré.

## You already have connect-c luminaires from the previous system! What now?

Sie besitzen bereits connect-c Leuchten des Vorgängersystems! Was nun?  
Vous disposez déjà de luminaires connect-c de l'ancien système! Que faire ?

No problem! The previous connect-c products are compatible with the new connect.z system.  
Kein Problem! Die bisherigen connect-c Produkte sind mit dem neuen connect.z System kompatibel.  
Aucun problème! Les anciens produits connect-c sont compatibles avec le nouveau système connect.z.

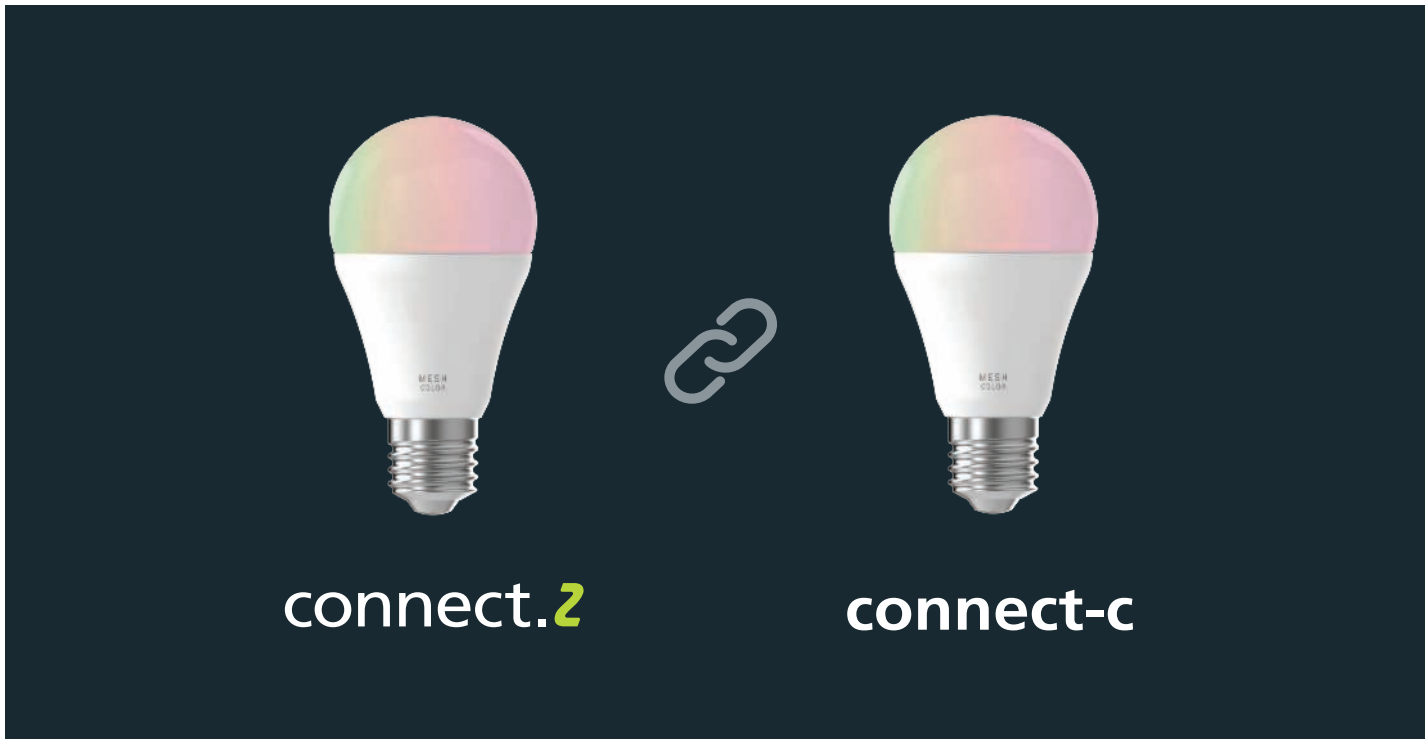

connect.z

connect-c

### EGLO connect-c - connect.z

The existing EGLO connect-c system is compatible with the new EGLO connect.z system. You don't need to switch from the existing Bluetooth low energy system to the new open protocol ZigBee 3.0. Lights from EGLO connect-c can be incorporated into the existing EGLO connect.z system.

### EGLO connect-c - connect.z

Das bestehende EGLO connect-c System ist mit dem neuen EGLO connect.z System kompatibel. Sie müssen nicht von dem bestehendem Bluetooth low energy System auf das neue offene Protokoll ZigBee 3.0 umsteigen. Leuchten von EGLO connect-c können in das bestehende EGLO connect.z System eingebunden werden.

### EGLO connect-c - connect.z

Le système EGLO connect-c existant est compatible avec le nouveau système EGLO connect.z. Vous n'avez pas besoin de passer du système Bluetooth à basse consommation existant au nouveau protocole ouvert ZigBee 3.0. Les luminaires EGLO connect-c peuvent être intégrés au système EGLO connect.z existant.





**99106**



120°, 12 m  
20 sec. - 10 min.

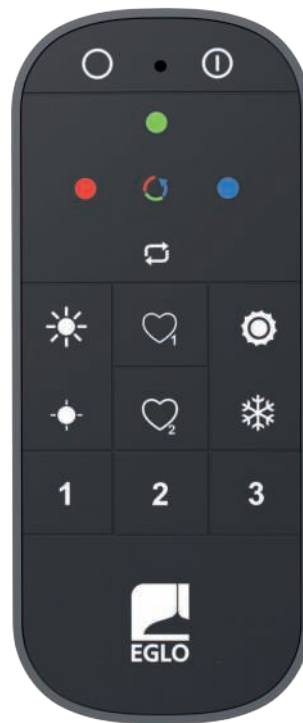

**99099**

### 99106 CONNECT-Z SENSOR

accessory; plastic, white  
Zubehör; Kunststoff, weiss  
accessoire; plastique, blanc

L 75, H 75, A 70



AA,  
LR6 HP



2900mA,  
1,5V



IP44



9 002759 991067



### 99099 CONNECT Z

remote control; plastic, grey  
Fernbedienung; Kunststoff, grau  
Télécommande; plastique, gris

L 122, B 54, H 18



AAA,  
R03P



1,5V



9 002759 990992

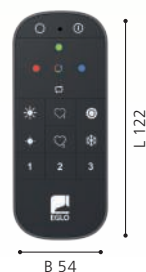



900387



900388



### 900387 ANCHORENA-Z

ceiling light; wood, steel, brown, black / plastic, white  
Deckenleuchte; Holz, Stahl, braun, schwarz / Kunststoff, weiss  
plafonnier; bois, acier, marron, noir / plastique, blanc

L 1230, B 80, H 110



35W



3980 lm



Remote,  
App



9 008606 243662



### 900388 ANCHORENA-Z

pendant light; wood, steel, brown, black / plastic, white  
Hängeleuchte; Holz, Stahl, braun, schwarz / Kunststoff, weiss  
luminaire en suspension; bois, acier, marron, noir / plastique, blanc

L 1230, B 55, H 1100



35W



3980 lm



Remote,  
App



9 008606 243679

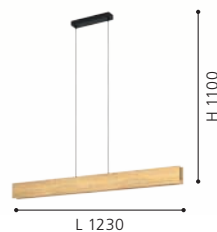

### 900391 ANCHORENA-Z

table light; wood, steel, brown, black / plastic, white  
Tischleuchte; Holz, Stahl, braun, schwarz / Kunststoff, weiss  
luminaire de table; bois, acier, marron, noir / plastique, blanc

L 75, B 55, H 465, Base: B 160, T 120



16W



1800 lm



Remote,  
App



9 008606 243693







900391



900392



**900392 ANCHORENA-Z**

floor light; wood, steel, brown, black / plastic, white  
 Stehleuchte; Holz, Stahl, braun, schwarz / Kunststoff, weiss  
 lampadaire; bois, acier, marron, noir / plastique, blanc

L 105, B 55, H 1500, Base: B 240, T 210





99679

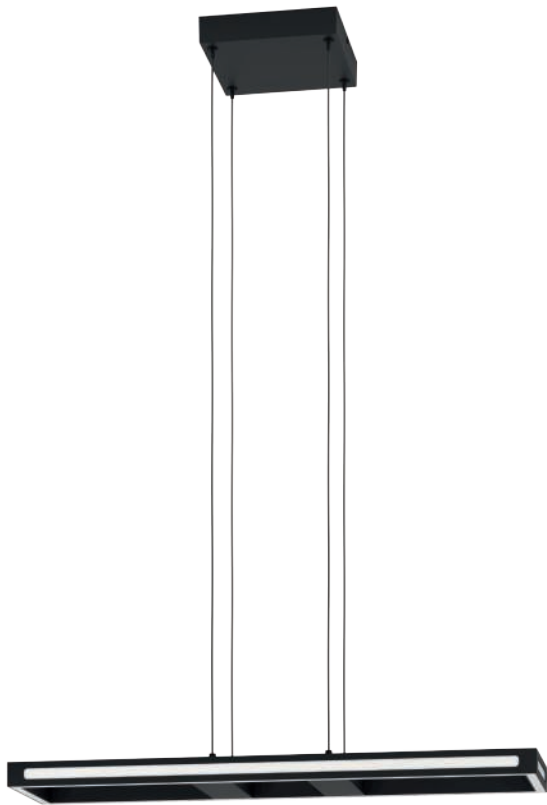

99678



99681



### 99679 SALVILANAS-Z

ceiling light; aluminium, steel, black / plastic, white  
Deckenleuchte; Alu, Stahl, schwarz / Kunststoff, weiss  
plafonnier; aluminium, acier, noir / plastique, blanc

L 770, B 200, H 75



21W 2700lm Remote, App



9 002759 996796



### 99678 SALVILANAS-Z

pendant light; aluminium, steel, black / plastic, white  
Hängeleuchte; Alu, Stahl, schwarz / Kunststoff, weiss  
luminaire en suspension; aluminium, acier, noir / plastique, blanc

L 770, B 200, H 1100



21W 2700lm Remote, App



9 002759 996789

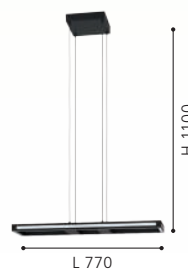

### 99681 SALVILANAS-Z

pendant light; aluminium, steel, black / plastic, white  
Hängeleuchte; Alu, Stahl, schwarz / Kunststoff, weiss  
luminaire en suspension; aluminium, acier, noir / plastique, blanc

L 1160, B 200, H 1100



33W 4300lm Remote, App



9 002759 996819







99682



99683



**99682 SALVILANAS-Z**

table light; aluminium, steel, black / plastic, white  
 Tischleuchte; Alu, Stahl, schwarz / Kunststoff, weiss  
 luminaire de table; aluminium, acier, noir / plastique, blanc

L 160, B 35, H 425, Base: B 240, T 160



9 002759 996826



**99683 SALVILANAS-Z**

floor light; aluminium, steel, black / plastic, white  
 Stehleuchte; Alu, Stahl, schwarz / Kunststoff, weiss  
 lampadaire; aluminium, acier, noir / plastique, blanc

L 200, B 35, H 1305, Base: B 280, T 180



9 002759 996833

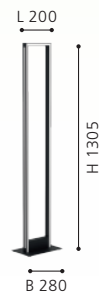

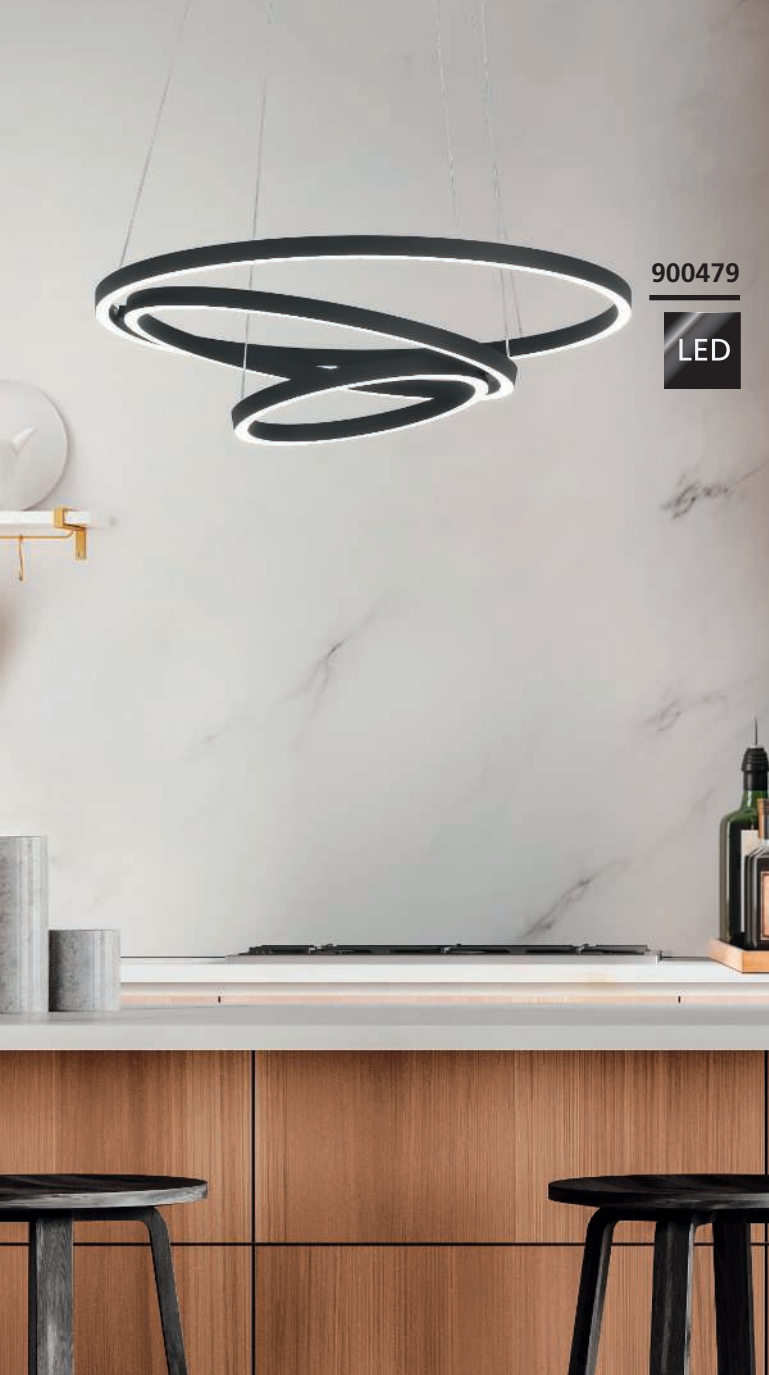

900479

LED



900478

LED

### 900479 LOBINERO-Z

pendant light; aluminium, steel, black / plastic, white  
 Hängeleuchte; Alu, Stahl, schwarz / Kunststoff, weiss  
 luminaire en suspension; aluminium, acier, noir / plastique, blanc

H 1100, Ø 580



43,2W



6000 lm



Remote,  
App



9 008606 244157

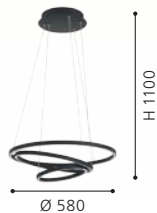

### 900478 LOBINERO-Z

pendant light; aluminium, steel, white / plastic, white  
 Hängeleuchte; Alu, Stahl, weiss / Kunststoff, weiss  
 luminaire en suspension; aluminium, acier, blanc / plastique, blanc

H 1100, Ø 580



43,2W



6000 lm



Remote,  
App



9 008606 244140



### 900398 ZILLERIO-Z

pendant light; steel, aluminium, black / plastic, white  
 Hängeleuchte; Stahl, Alu, schwarz / Kunststoff, weiss  
 luminaire en suspension; acier, aluminium, noir / plastique, blanc

L 1160, B 300, H 1100



2x 8W



2160 lm



3x 2,7W



Remote,  
App



9 008606 240593

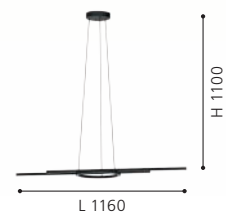





900398

LED

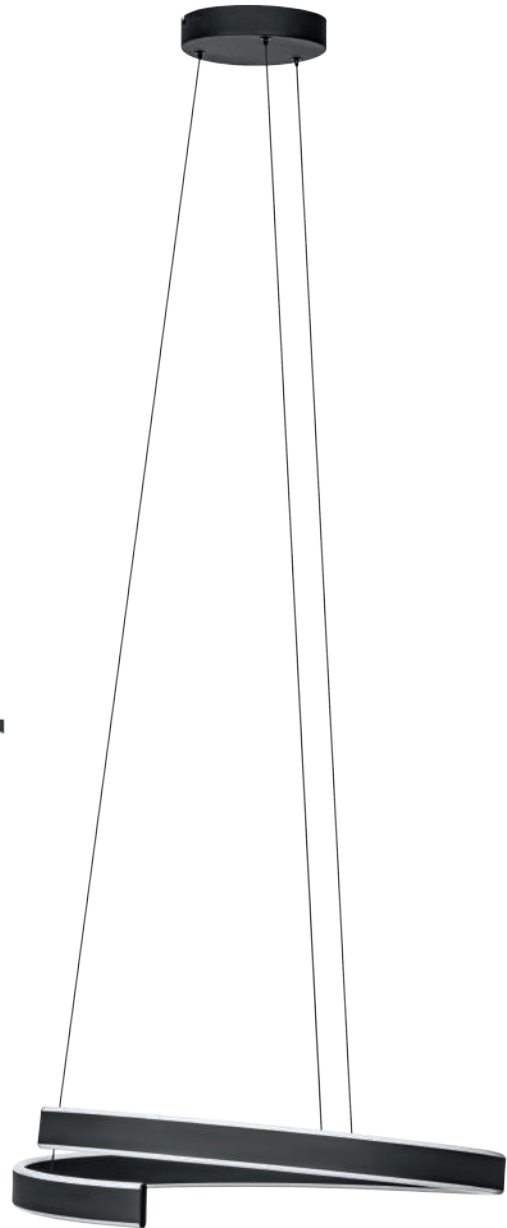

900404

LED

### 900404 ANDABAIA-Z

pendant light; aluminium, steel, black / plastic, white  
 Hängeleuchte; Alu, Stahl, schwarz / Kunststoff, weiss  
 luminaire en suspension; aluminium, acier, noir / plastique, blanc

H 1540, Ø 600

LED

42,5W

tunable  
WHITE

5300lm

CONTROL  
UNIT

Remote,  
App

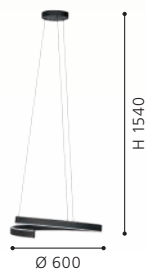



900336

LED



900337

LED



900338

LED



### 900336 TELIMBELA-Z

spot; steel, black  
Spot; Stahl, schwarz  
spot; acier, noir

H 97, Ø 250



GU10



3x 4,9W



3x 345lm



Remote, App



### 900337 TELIMBELA-Z

spot; steel, black  
Spot; Stahl, schwarz  
spot; acier, noir

L 580, B 80, H 97



GU10



4x 4,9W



4x 345lm



Remote, App



### 900338 TELIMBELA-Z

spot; steel, white  
Spot; Stahl, weiss  
spot; acier, blanc

H 97, Ø 250



GU10



3x 4,9W



3x 345lm



Remote, App



9 008606 239948



9 008606 239955



9 008606 239962







900339

LED

**900339 TELIMBELA-Z**

spot; steel, white  
 Spot; Stahl, weiss  
 spot; acier, blanc

L 580, B 80, H 97



GU10



4x 4,9W



4x  
 345 lm



Remote,  
 App



9 008606 239979

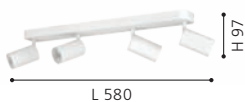



900407

LED



900406

LED



DIMMABLE  
VIA REMOTE  
AND APP

### 900407 TOLLOS-Z

ceiling light; aluminium, steel, black, white / plastic, white  
Deckenleuchte; Alu, Stahl, schwarz, weiss / Kunststoff, weiss  
plafonnier; aluminium, acier, noir, blanc / plastique, blanc

H 130, Ø 550



3x 11 W



3750 lm



Remote,  
App



9 008606 243808



### 900406 TOLLOS-Z

ceiling light; aluminium, steel, black, white / plastic, white  
Deckenleuchte; Alu, Stahl, schwarz, weiss / Kunststoff, weiss  
plafonnier; aluminium, acier, noir, blanc / plastique, blanc

H 130, Ø 400



3x 7,5 W



2700 lm



Remote,  
App



9 008606 243792



### 900439 ROMA0-Z

ceiling light; steel, white / fabric, plastic, white  
Deckenleuchte; Stahl, weiss / Textil, Kunststoff, weiss  
plafonnier; acier, blanc / tissu, plastique, blanc

H 150, Ø 570



35 W



3500 lm



Remote,  
App



9 008606 243914





900439



900441



900442



### 900441 ROMAO-Z

ceiling light; steel, white / fabric, plastic, taupe, white  
 Deckenleuchte; Stahl, weiss / Textil, Kunststoff, taupe, weiss  
 plafonnier; acier, blanc / tissu, plastique, taupe, blanc

H 150, Ø 570

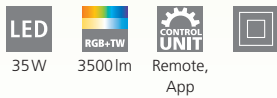

### 900442 ROMAO-Z

ceiling light; steel, white / fabric linen, plastic, grey, white  
 Deckenleuchte; Stahl, weiss / Textil Leinen, Kunststoff, grau, weiss  
 plafonnier; acier, blanc / tissu de lin, plastique, gris, blanc

H 150, Ø 570

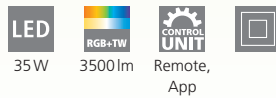

9 008606 243921

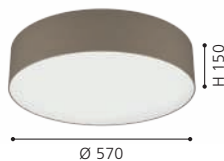

9 008606 243938







900408



900409



900411



### 900408 MONTEMORELOS-Z

ceiling light; aluminium, white / plastic with crystal effect, white  
Deckenleuchte; Alu, weiss / Kunststoff m. Kristalleffekt, weiss  
plafonnier; aluminium, blanc / plastique avec effet cristal, blanc

H 50, Ø 420



17,8W



2150lm



Remote,  
App



9 008606 243815

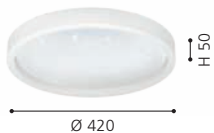

### 900409 MONTEMORELOS-Z

ceiling light; aluminium, white / plastic with crystal effect, white  
Deckenleuchte; Alu, weiss / Kunststoff m. Kristalleffekt, weiss  
plafonnier; aluminium, blanc / plastique avec effet cristal, blanc

H 70, Ø 570



34,5W



4100lm



Remote,  
App



9 008606 243822



### 900411 MONTEMORELOS-Z

ceiling light; aluminium, black / plastic with crystal effect, white  
Deckenleuchte; Alu, schwarz / Kunststoff m. Kristalleffekt, weiss  
plafonnier; aluminium, noir / plastique avec effet cristal, blanc

H 50, Ø 420



17,8W



2150lm



Remote,  
App



9 008606 243839





900412



900636



### MONTEMORELOS-Z, GENOVESE-Z

The frame of these luminaires can switch between the RGB colors, the inner part can reproduce different white tones between 2700K and 6500K. By controlling via app or remote control, individual lighting effects can be set.

Der Rahmen dieser Leuchten kann zwischen den RGB Farbtönen wechseln, der Innenteil kann verschiedene Weißtöne zwischen 2700K und 6500K wiedergeben. Durch Steuerung per App oder Fernbedienung können so individuelle Lichtspiele eingestellt werden.

Le cadre de cette luminaires peut basculer entre les couleurs RVB, la partie intérieure peut reproduire différents tons blancs entre 2700K et 6500K. En contrôlant via l'application ou la télécommande, des effets d'éclairage individuels peuvent être définis.



900477



### 900412 MONTEMORELOS-Z

ceiling light; aluminium, black / plastic with crystal effect, white  
Deckenleuchte; Alu, schwarz / Kunststoff m. Kristalleffekt, weiss  
plafonnier; aluminium, noir / plastique avec effet cristal, blanc

H 70, Ø 570

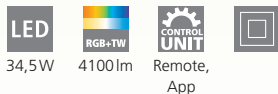

34,5W 4100lm Remote, App



9 008606 243846



### 900636 TOTARI-Z

ceiling light; steel, white / plastic with crystal effect, white  
Deckenleuchte; Stahl, weiss / Kunststoff m. Kristalleffekt, weiss  
plafonnier; acier, blanc / plastique avec effet cristal, blanc

H 70, Ø 380



4x 4,8W 2160lm Remote, App



9 008606 245208

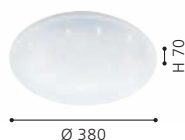

### 900477 GENOVESE-Z

ceiling light; aluminium, steel, black / plastic, white  
Deckenleuchte; Alu, Stahl, schwarz / Kunststoff, weiss  
plafonnier; aluminium, acier, noir / plastique, blanc

L 470, B 470, H 70



22W 3000lm Remote, App



9 008606 252763

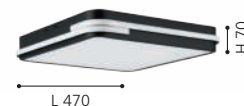



900322



900323



900324



### 900322 PARRAPOS-Z

ceiling light; steel, black / plastic, white  
Deckenleuchte; Stahl, schwarz / Kunststoff, weiss  
plafonnier; acier, noir / plastique, blanc

L 445, B 300, H 70



### 900323 PARRAPOS-Z

ceiling light; steel, black / plastic, white  
Deckenleuchte; Stahl, schwarz / Kunststoff, weiss  
plafonnier; acier, noir / plastique, blanc

L 340, B 300, H 45



### 900324 PARRAPOS-Z

wall light; steel, black / plastic, white  
Wandleuchte; Stahl, schwarz / Kunststoff, weiss  
applique; acier, noir / plastique, blanc

L 200, H 240, A 50



9 008606 231256



9 008606 231263



9 008606 231270







900319



900321



**900319 PARRAPOS-Z**

ceiling light; steel, black / plastic, white  
 Deckenleuchte; Stahl, schwarz / Kunststoff, weiss  
 plafonnier; acier, noir / plastique, blanc

L 615, B 450, H 80



**900321 PARRAPOS-Z**

ceiling light; steel, black / plastic, white  
 Deckenleuchte; Stahl, schwarz / Kunststoff, weiss  
 plafonnier; acier, noir / plastique, blanc

L 545, B 445, H 90



9 008606 231232

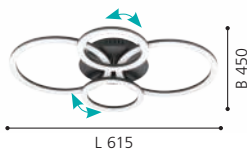

9 008606 231249

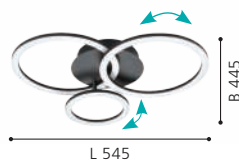

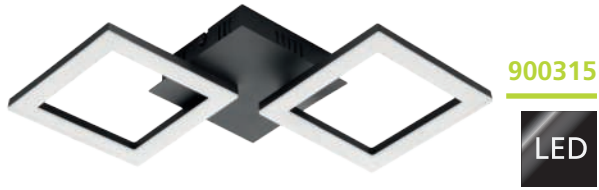

900315

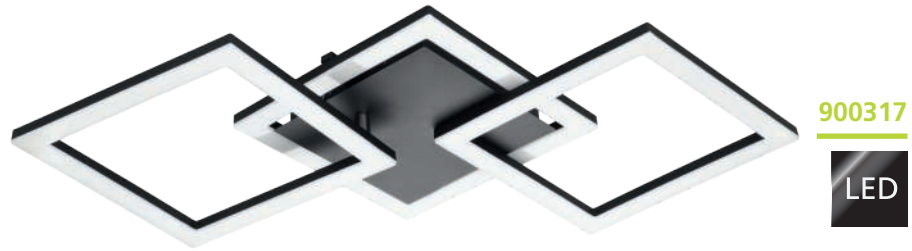

900317

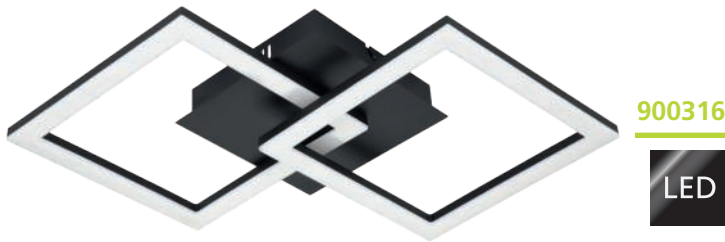

900316



### 900315 PARANDAY-Z

ceiling light; steel, black / plastic, white  
Deckenleuchte; Stahl, schwarz / Kunststoff, weiss  
plafonnier; acier, noir / plastique, blanc

L 470, B 225, H 60



15,5W 1800lm Remote, App

### 900316 PARANDAY-Z

ceiling light; steel, black / plastic, white  
Deckenleuchte; Stahl, schwarz / Kunststoff, weiss  
plafonnier; acier, noir / plastique, blanc

L 525, B 310, H 60



21,5W 2500lm Remote, App

### 900317 PARANDAY-Z

ceiling light; steel, black / plastic, white  
Deckenleuchte; Stahl, schwarz / Kunststoff, weiss  
plafonnier; acier, noir / plastique, blanc

L 650, B 310, H 60



32,4W 4000lm Remote, App



9 008606 231195

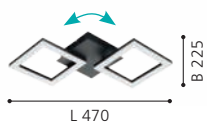

9 008606 231201

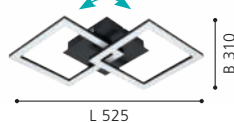

9 008606 231218

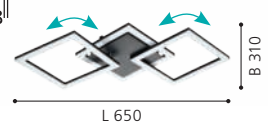



900318



900566

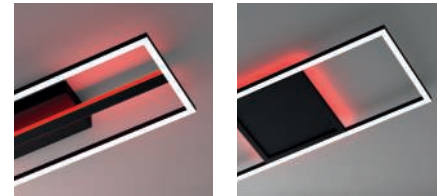

900567



### CALAGRANO-Z

These lights have individually controllable light settings on the inside and outside of the frame.

Diese Leuchten verfügen über individuell steuerbare Lichteinstellungen der Rahmen innen und außen.

Ces lumières ont des paramètres d'éclairage contrôlables individuellement du cadre.

### 900318 PARANDAY-Z

ceiling light; steel, black / plastic, white  
Deckenleuchte; Stahl, schwarz / Kunststoff, weiss  
plafonnier; acier, noir / plastique, blanc

L 470, B 430, H 65



9 008606 231225



### 900566 CALAGRANO-Z

ceiling light; aluminium, steel, black / plastic, white  
Deckenleuchte; Alu, Stahl, schwarz / Kunststoff, weiss  
plafonnier; aluminium, acier, noir / plastique, blanc

L 640, B 240, H 45



9 008606 244683

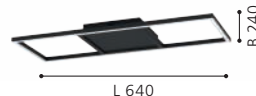

### 900567 CALAGRANO-Z

ceiling light; aluminium, steel, black / plastic, white  
Deckenleuchte; Alu, Stahl, schwarz / Kunststoff, weiss  
plafonnier; aluminium, acier, noir / plastique, blanc

L 640, B 220, H 50



9 008606 244690







900481



900484



900483



### 900481 PADROGIANO-Z

ceiling light; steel, white / plastic, white  
Deckenleuchte; Stahl, weiss / Kunststoff, weiss  
plafonnier; acier, blanc / plastique, blanc

L 450, B 450, H 50

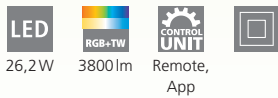

26,2W 3800lm Remote, App

### 900483 PADROGIANO-Z

ceiling light; steel, white / plastic, white  
Deckenleuchte; Stahl, weiss / Kunststoff, weiss  
plafonnier; acier, blanc / plastique, blanc

L 450, B 450, H 50



27,9W 3600lm Remote, App

### 900484 PADROGIANO-Z

ceiling light; steel, white / plastic, white  
Deckenleuchte; Stahl, weiss / Kunststoff, weiss  
plafonnier; acier, blanc / plastique, blanc

L 595, B 595, H 50

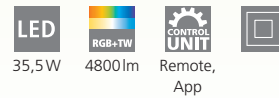

35,5W 4800lm Remote, App



9 008606 244164



9 008606 244188



9 008606 244195





900486

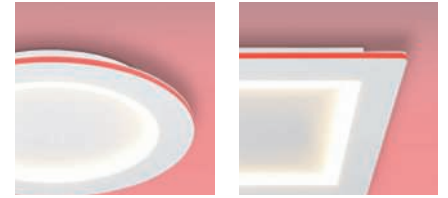

### PADROGIANO-Z

These lights have individually controllable light settings on the inside and outside of the frame.

Diese Leuchten verfügen über individuell steuerbare Lichteinstellungen der Rahmen innen und außen.

Ces lumières ont des paramètres d'éclairage contrôlables individuellement du cadre.



900487



### 900486 PADROGIANO-Z

ceiling light; steel, white / plastic, white  
Deckenleuchte; Stahl, weiss / Kunststoff, weiss  
plafonnier; acier, blanc / plastique, blanc

H 50, Ø 450

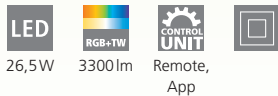

26,5W

3300lm

Remote,  
App

### 900487 PADROGIANO-Z

ceiling light; steel, white / plastic, white  
Deckenleuchte; Stahl, weiss / Kunststoff, weiss  
plafonnier; acier, blanc / plastique, blanc

H 50, Ø 595



35W

4600lm

Remote,  
App



9 008606 244218



9 008606 244225





900482



### PADROGIANO-Z

The frame of these luminaires can switch between the RGB colors, the inner part can reproduce different white tones between 2700K and 6500K. By controlling via app or remote control, individual lighting effects can be set.

Der Rahmen dieser Leuchten kann zwischen den RGB Farbtönen wechseln, der Innenteil kann verschiedene Weißtöne zwischen 2700K und 6500K wiedergeben. Durch Steuerung per App oder Fernbedienung können so individuelle Lichtspiele eingestellt werden.

Le cadre de cette luminaires peut basculer entre les couleurs RVB, la partie intérieure peut reproduire différents tons blancs entre 2700K et 6500K.

En contrôlant via l'application ou la télécommande, des effets d'éclairage individuels peuvent être définis.



### 900482 PADROGIANO-Z

ceiling light; steel, white / plastic, white  
Deckenleuchte; Stahl, weiss / Kunststoff, weiss  
plafonnier; acier, blanc / plastique, blanc

L 1200, B 300, H 50



42,5 W 6000 lm Remote, App



9 008606 244171



### 900485 PADROGIANO-Z

ceiling light; steel, white / plastic, white  
Deckenleuchte; Stahl, weiss / Kunststoff, weiss  
plafonnier; acier, blanc / plastique, blanc

L 1200, B 300, H 50



43,2 W 6000 lm Remote, App



9 008606 244201

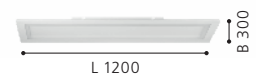



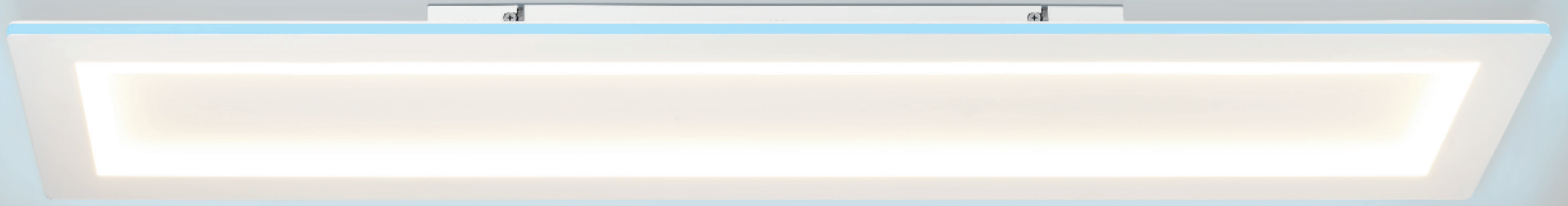

900485

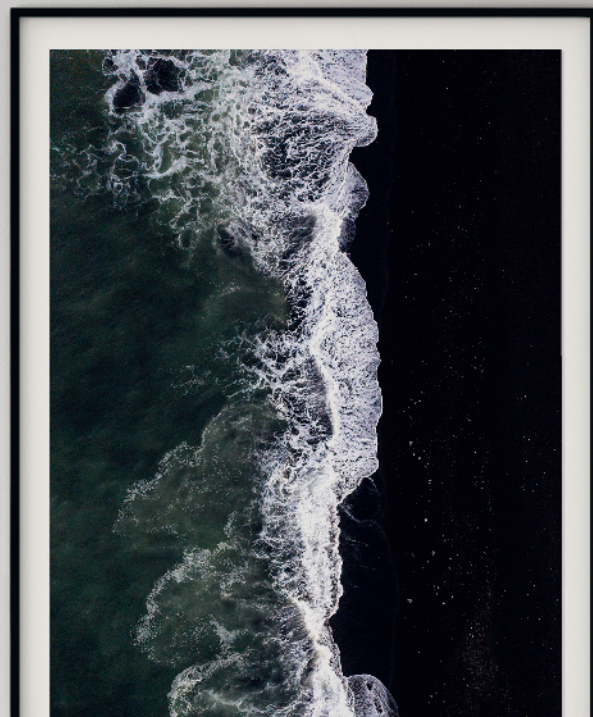



900075

LED

99601

LED

99603

LED

### 900075 VALDELAGRANO-Z

pendant light; steel, wood, black / fabric, white  
 Hängeleuchte; Stahl, Holz, schwarz / Textil, weiss  
 luminaire en suspension; acier, bois, noir / tissu, blanc

L 1000, B 105, H 1100

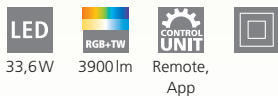

9 008606 222094



### 99603 SIMOLARIS-Z

pendant light; aluminium, steel, black / plastic, white  
 Hängeleuchte; Alu, Stahl, schwarz / Kunststoff, weiss  
 luminaire en suspension; aluminium, acier, noir / plastique, blanc

L 1220, B 55, H 1100



9 002759 996031



### 99601 SIMOLARIS-Z

ceiling light; aluminium, steel, black / plastic, white  
 Deckenleuchte; Alu, Stahl, schwarz / Kunststoff, weiss  
 plafonnier; aluminium, acier, noir / plastique, blanc

L 470, B 55, H 110

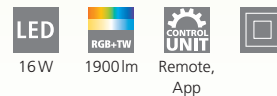

9 002759 996017





99602

LED



99604

LED

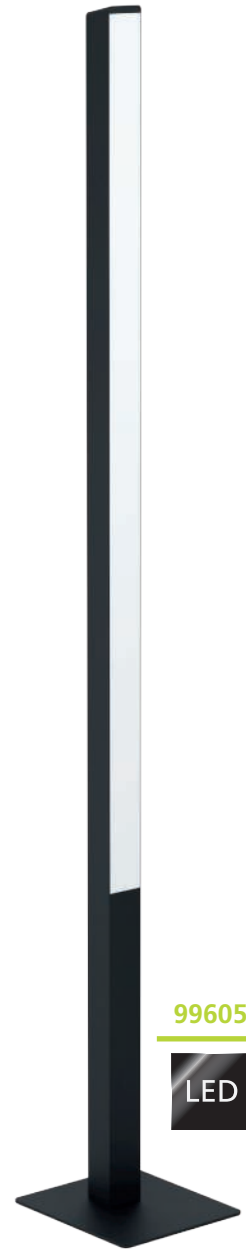

99605

LED

### 99602 SIMOLARIS-Z

ceiling light; aluminium, steel, black / plastic, white  
Deckenleuchte; Alu, Stahl, schwarz / Kunststoff, weiss  
plafonnier; aluminium, acier, noir / plastique, blanc

L 1220, B 55, H 110

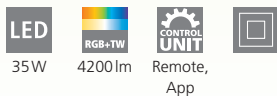

35W 4200lm Remote, App



9 002759 996024



### 99604 SIMOLARIS-Z

table light; aluminium, steel, black / plastic, white  
Tischleuchte; Alu, Stahl, schwarz / Kunststoff, weiss  
luminaire de table; aluminium, acier, noir / plastique, blanc

L 55, B 55, H 515, Base: B 160, T 120



16W 1900lm Remote, App



9 002759 996048



### 99605 SIMOLARIS-Z

floor light; aluminium, steel, black / plastic, white  
Stehleuchte; Alu, Stahl, schwarz / Kunststoff, weiss  
lampadaire; aluminium, acier, noir / plastique, blanc

L 55, B 55, H 1615, Base: B 240, T 210



35W 4200lm Remote, App



9 002759 996055

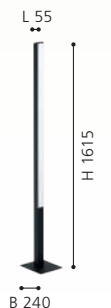



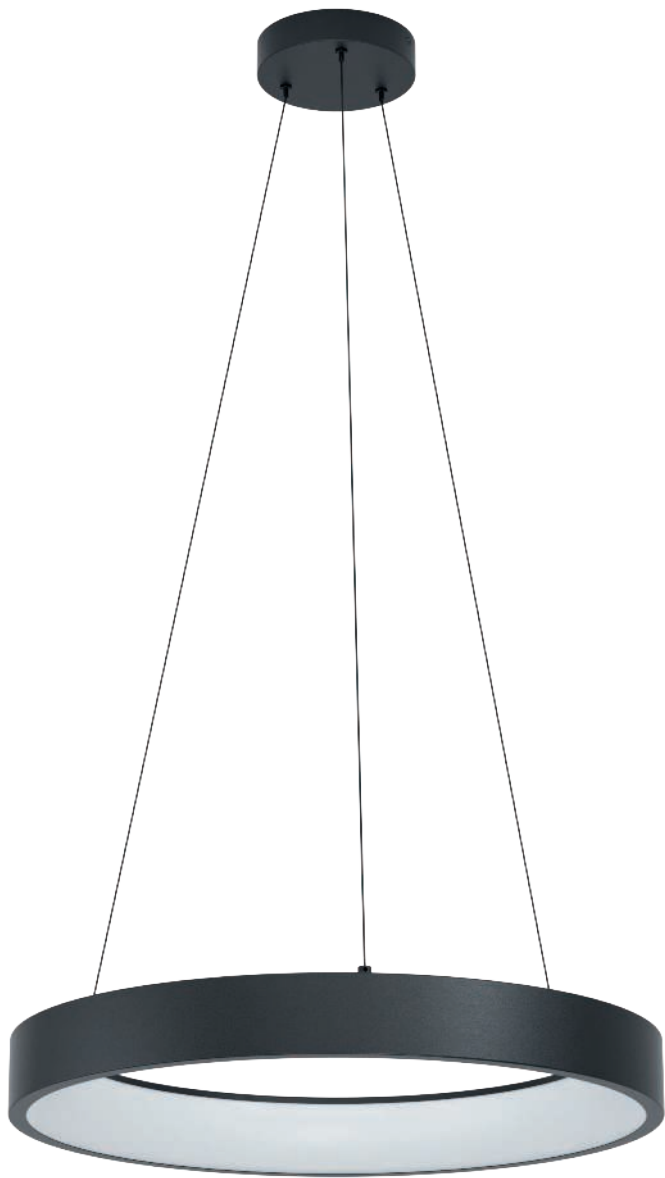

900068



900067



900069



### 900068 MARGHERA-Z

pendant light; steel, black / plastic, white  
 Hängeleuchte; Stahl, schwarz / Kunststoff, weiss  
 luminaire en suspension; acier, noir / plastique, blanc

H 1100, Ø 600



4x 6,5W



3120lm



Remote,  
App

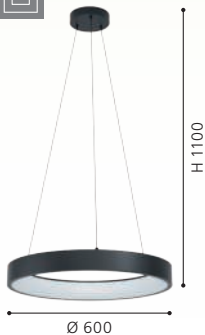

9 008606 222032

### 900067 MARGHERA-Z

ceiling light; steel, black / plastic, white  
 Deckenleuchte; Stahl, schwarz / Kunststoff, weiss  
 plafonnier; acier, noir / plastique, blanc

H 110, Ø 600



4x 6,5W



3120lm



Remote,  
App



9 008606 222025



### 900069 MARGHERA-Z

wall light; steel, black / plastic, white  
 Wandleuchte; Stahl, schwarz / Kunststoff, weiss  
 applique; acier, noir / plastique, blanc

L 270, H 305, A 200



4x 4W



1800lm



Remote,  
App



9 008606 222049





900071



900072



**900071 MARGHERA-Z**

table light; steel, black / plastic, white  
Tischleuchte; Stahl, schwarz / Kunststoff, weiss  
luminaire de table; acier, noir / plastique, blanc

L 270, H 265, Base: Ø 145



**900072 MARGHERA-Z**

floor light; steel, black / plastic, white  
Stehleuchte; Stahl, schwarz / Kunststoff, weiss  
lampadaire; acier, noir / plastique, blanc

L 270, B 305, H 1690, Base: Ø 305

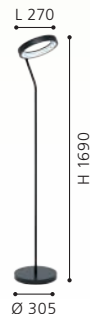



99673

LED



99674

LED



99675

LED



### 99673 CAMINALES-Z

ceiling light; steel, black  
Deckenleuchte; Stahl, schwarz  
plafonnier; acier, noir

L 125, B 125, H 120



GU10



1x 5W



1x

345lm



Remote,

App



### 99674 CAMINALES-Z

ceiling light; steel, black  
Deckenleuchte; Stahl, schwarz  
plafonnier; acier, noir

L 240, B 125, H 120



GU10



2x 5W



2x

345lm



Remote,

App



### 99675 CAMINALES-Z

ceiling light; steel, black  
Deckenleuchte; Stahl, schwarz  
plafonnier; acier, noir

L 240, B 240, H 120



GU10



4x 5W



4x

345lm



Remote,

App

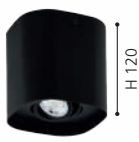



99669

LED



DESIGN  
HIGHLIGHT  
DETAIL



99671

LED



99672

LED

### 99669 SALICETO-Z

recessed light; aluminium, black  
Einbauleuchte; Alu, schwarz  
luminaire encastrable; aluminium, noir

H 46, Ø 88, ET 50

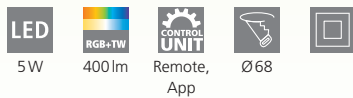

### 99671 SALICETO-Z

recessed light; aluminium, white  
Einbauleuchte; Alu, weiss  
luminaire encastrable; aluminium, blanc

H 46, Ø 88, ET 50

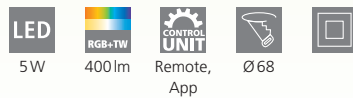

### 99672 SALICETO-Z

recessed light; aluminium, satin nickel  
Einbauleuchte; Alu, nickel-matt  
luminaire encastrable; aluminium, nickel mat

H 46, Ø 88, ET 50

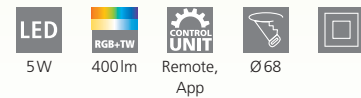





99677

LED



99676

LED

DIMMABLE  
VIA REMOTE  
AND APP



### 99677 LOMALTAS-Z

ceiling light; steel, wood, black, brown / plastic, white  
Deckenleuchte; Stahl, Holz, schwarz, braun / Kunststoff, weiss  
plafonnier; acier, bois, noir, marron / plastique, blanc

L 770, B 495, H 85



4x 8W



4400lm



Remote,  
App



### 99676 LOMALTAS-Z

ceiling light; steel, wood, black, brown / plastic, white  
Deckenleuchte; Stahl, Holz, schwarz, braun / Kunststoff, weiss  
plafonnier; acier, bois, noir, marron / plastique, blanc

L 580, B 350



4x 8W



4400lm



Remote,  
App



9 002759 996772

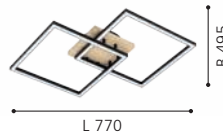

9 002759 996765





900019

LED



900021

LED



99588

LED

### 900019 TABIANO-Z

mirror light; steel, chrome / plastic, white  
Spiegelleuchte; Stahl, chrom / Kunststoff, weiss  
applique pour miroir; acier, chrome / plastique, blanc

L 605, H 70, A 135

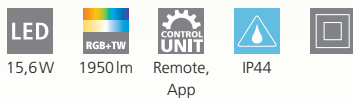

15,6W

1950lm

Remote,  
App

IP44

### 900021 TABIANO-Z

mirror light; steel, chrome / plastic, white  
Spiegelleuchte; Stahl, chrom / Kunststoff, weiss  
applique pour miroir; acier, chrome / plastique, blanc

L 905, H 70, A 135

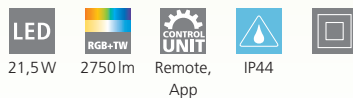

21,5W

2750lm

Remote,  
App

IP44

### 99588 JUAREZA-Z

mirror light; steel, white / mirror  
Spiegelleuchte; Stahl, weiss / Spiegel  
applique pour miroir; acier, blanc / miroir

L 700, H 500, A 55



20W

2300lm

Remote,  
App

IP44



9 008606 221646

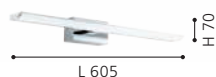

9 008606 221653



9 002759 995881

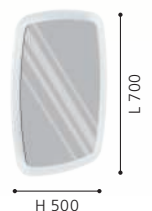



900079



900081

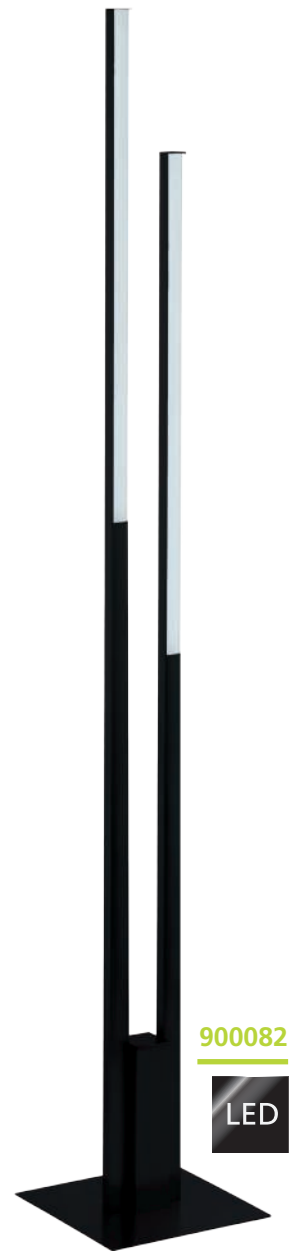

900082



### 900079 FRAIOLI-Z

ceiling light; aluminium, black / plastic, white  
Deckenleuchte; Alu, schwarz / Kunststoff, weiss  
plafonnier; aluminium, noir / plastique, blanc

L 1055, B 120, H 65



2x 17W



4800lm



Remote,  
App



9 008606 223565



### 900081 FRAIOLI-Z

pendant light; aluminium, black / plastic, white  
Hängeleuchte; Alu, schwarz / Kunststoff, weiss  
luminaire en suspension; aluminium, noir / plastique, blanc

L 1055, B 100, H 1200



2x 17W



4800lm



Remote,  
App



9 008606 223572



### 900082 FRAIOLI-Z

floor light; aluminium, black / plastic, white  
Stehleuchte; Alu, schwarz / Kunststoff, weiss  
lampadaire; aluminium, noir / plastique, blanc

H 1755, Base: B 280, T 280



2x 17W



4800lm



Remote,  
App



9 008606 223589

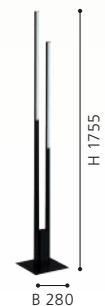



900076



900077



900078



### 900076 FRAIOLI-Z

ceiling light; aluminium, satin nickel / plastic, white  
Deckenleuchte; Alu, nickel-matt / Kunststoff, weiss  
plafonnier; aluminium, nickel mat / plastique, blanc

L 1055, B 120, H 65



2x 17W 4800lm Remote, App



9 008606 223534



### 900077 FRAIOLI-Z

pendant light; aluminium, satin nickel / plastic, white  
Hängeleuchte; Alu, nickel-matt / Kunststoff, weiss  
luminaire en suspension; aluminium, nickel mat / plastique, blanc

L 1055, B 100, H 1200



2x 17W 4800lm Remote, App



9 008606 223541



### 900078 FRAIOLI-Z

floor light; aluminium, satin nickel / plastic, white  
Stehleuchte; Alu, nickel-matt / Kunststoff, weiss  
lampadaire; aluminium, nickel mat / plastique, blanc

H 1755, Base: B 280, T 280



2x 17W 4800lm Remote, App



9 008606 223558







900001



900002



900084



### 900001 TOTARI-Z

ceiling light; steel, white / plastic with crystal effect, white  
Deckenleuchte; Stahl, weiss / Kunststoff m. Kristalleffekt, weiss  
plafonnier; acier, blanc / plastique avec effet cristal, blanc

H 70, Ø 380

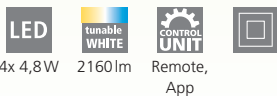

### 900002 TOTARI-Z

ceiling light; steel, white / plastic with crystal effect, white  
Deckenleuchte; Stahl, weiss / Kunststoff m. Kristalleffekt, weiss  
plafonnier; acier, blanc / plastique avec effet cristal, blanc

H 70, Ø 530

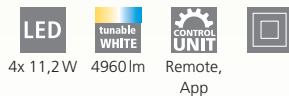

### 900084 TOTARI-Z

ceiling light; steel, white / plastic, white  
Deckenleuchte; Stahl, weiss / Kunststoff, weiss  
plafonnier; acier, blanc / plastique, blanc

H 70, Ø 380

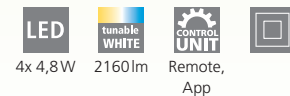

9 008606 221479

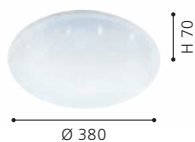

9 008606 221486

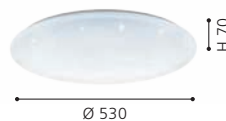

9 008606 225453

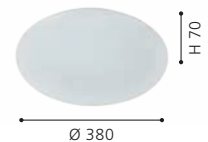

900085

LED



### 900085 TOTARI-Z

ceiling light; steel, white / plastic, white  
Deckenleuchte; Stahl, weiss / Kunststoff, weiss  
plafonnier; acier, blanc / plastique, blanc

H 70, Ø 530



4x 11,2W



4960lm



Remote,  
App



9 008606 225460





900083



900005



900006



### 900083 LANCIANO-Z

ceiling light; steel, white, transparent / plastic with crystal effect, white, chrome

Deckenleuchte; Stahl, weiss, transparent / Kunststoff m.Kristalleffekt, weiss, chrom

plafonnier; acier, blanc, transparent / plastique avec effet cristal, blanc, chrome  
H 80, Ø 450



4x 4,8W

2160lm

Remote,  
App

### 900005 LANCIANO-Z

ceiling light; steel, white, transparent / plastic with crystal effect, white, chrome

Deckenleuchte; Stahl, weiss, transparent / Kunststoff m.Kristalleffekt, weiss, chrom

plafonnier; acier, blanc, transparent / plastique avec effet cristal, blanc, chrome  
H 80, Ø 560



4x 11,2W

4960lm

Remote,  
App

### 900006 LANCIANO-Z

ceiling light; steel, white, transparent / plastic with crystal effect, white, chrome

Deckenleuchte; Stahl, weiss, transparent / Kunststoff m.Kristalleffekt, weiss, chrom

plafonnier; acier, blanc, transparent / plastique avec effet cristal, blanc, chrome  
H 95, Ø 770



38,1W

5350lm

Remote,  
App



9 008606 225446

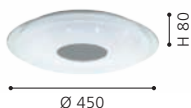

9 008606 221516



9 008606 221523





900008

LED



900128

LED



900129

LED

### 900008 CAPASSO-Z

wall / ceiling light; steel, white / plastic, white, chrome  
Wand- / Deckenleuchte; Stahl, weiss / Kunststoff, weiss, chrom  
applique / plafonnier; acier, blanc / plastique, blanc, chrome

H 70, Ø 340



4x 3,9W 1880lm Remote, App

### 900128 SILERAS-Z

ceiling light; steel, white / plastic with crystal effect, white  
Deckenleuchte; Stahl, weiss / Kunststoff m.Kristalleffekt, weiss  
plafonnier; acier, blanc / plastique avec effet cristal, blanc

H 60, Ø 430



3x 7,2W 2700lm Remote, App

### 900129 SILERAS-Z

ceiling light; steel, white / plastic with crystal effect, white  
Deckenleuchte; Stahl, weiss / Kunststoff m.Kristalleffekt, weiss  
plafonnier; acier, blanc / plastique avec effet cristal, blanc

H 60, Ø 600

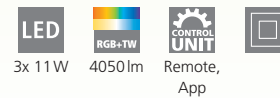

3x 11W 4050lm Remote, App



9 008606 221547

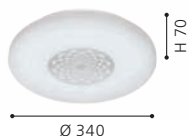

9 008606 226054



9 008606 226061

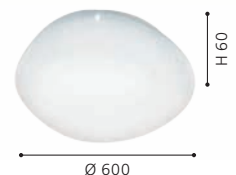





900025



900023, 900025

One frame of the luminaires is rotatable.  
Ein Rahmen der Leuchten ist drehbar.  
Un cadre de les luminaires est rotatif.

**900025 SAVATARILA-Z**

ceiling light; steel, black / plastic, white  
Deckenleuchte; Stahl, schwarz / Kunststoff, weiss  
plafonnier; acier, noir / plastique, blanc

L 450, B 450, H 70



4x 2,7W



1320lm



4x 2,7W



Remote,  
App



9 008606 221691

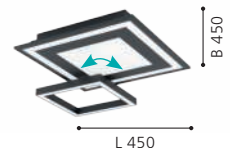



900022



900024



900023



### 900023 SAVATARILA-Z

ceiling light; steel, white / plastic, white  
Deckenleuchte; Stahl, weiss / Kunststoff, weiss  
plafonnier; acier, blanc / plastique, blanc

L 450, B 450, H 70

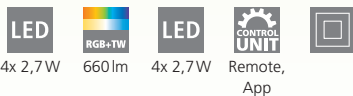

### 900022 SALITERAS-Z

ceiling light; steel, white / plastic, white  
Deckenleuchte; Stahl, weiss / Kunststoff, weiss  
plafonnier; acier, blanc / plastique, blanc

L 1160, B 160, H 50



### 900024 SALITERAS-Z

ceiling light; steel, black / plastic, white  
Deckenleuchte; Stahl, schwarz / Kunststoff, weiss  
plafonnier; acier, noir / plastique, blanc

L 1160, B 160, H 50



9 008606 221677

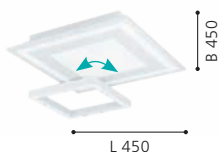

9 008606 221660



9 008606 221684





900054



900056



### TURCONA-Z

Frameless luminaire

Rahmenlose Leuchte

Luminaire sans cadre



### 900054 TURCONA-Z

ceiling light; steel, aluminium, white / plastic, white  
Deckenleuchte; Stahl, Alu, weiss / Kunststoff, weiss  
plafonnier; acier, aluminium, blanc / plastique, blanc

H 60, Ø 300



15,7W



1730lm



Remote,  
App



### 900056 TURCONA-Z

ceiling light; steel, aluminium, white / plastic, white  
Deckenleuchte; Stahl, Alu, weiss / Kunststoff, weiss  
plafonnier; acier, aluminium, blanc / plastique, blanc

H 75, Ø 600



34,2W



3980lm



Remote,  
App



### 900055 TURCONA-Z

ceiling light; steel, aluminium, white / plastic, white  
Deckenleuchte; Stahl, Alu, weiss / Kunststoff, weiss  
plafonnier; acier, aluminium, blanc / plastique, blanc

H 75, Ø 450



22,4W



2490lm



Remote,  
App



9 008606 221905



9 008606 221929

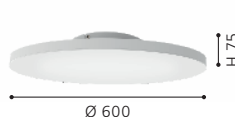

9 008606 221912





900055

LED

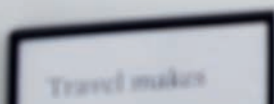
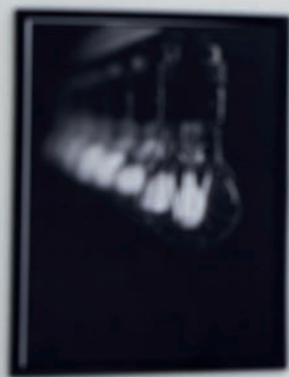





99548



99549



### 99548 HERRORA-Z

ceiling light; aluminium, white / plastic, white  
Deckenleuchte; Alu, weiss / Kunststoff, weiss  
plafonnier; aluminium, blanc / plastique, blanc

L 595, B 595, H 40

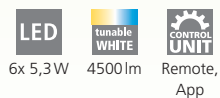

### 99549 HERRORA-Z

ceiling light; aluminium, white / plastic, white  
Deckenleuchte; Alu, weiss / Kunststoff, weiss  
plafonnier; aluminium, blanc / plastique, blanc

L 1200, B 300, H 40



### 99639 HERRORA-Z

ceiling light; aluminium, white / plastic, white  
Deckenleuchte; Alu, weiss / Kunststoff, weiss  
plafonnier; aluminium, blanc / plastique, blanc

L 450, B 450, H 40



9 002759 995485

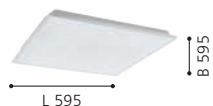

9 002759 995492



9 002759 996390

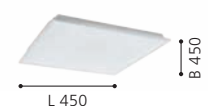



99639





**900057**  
LED

**900058**  
LED

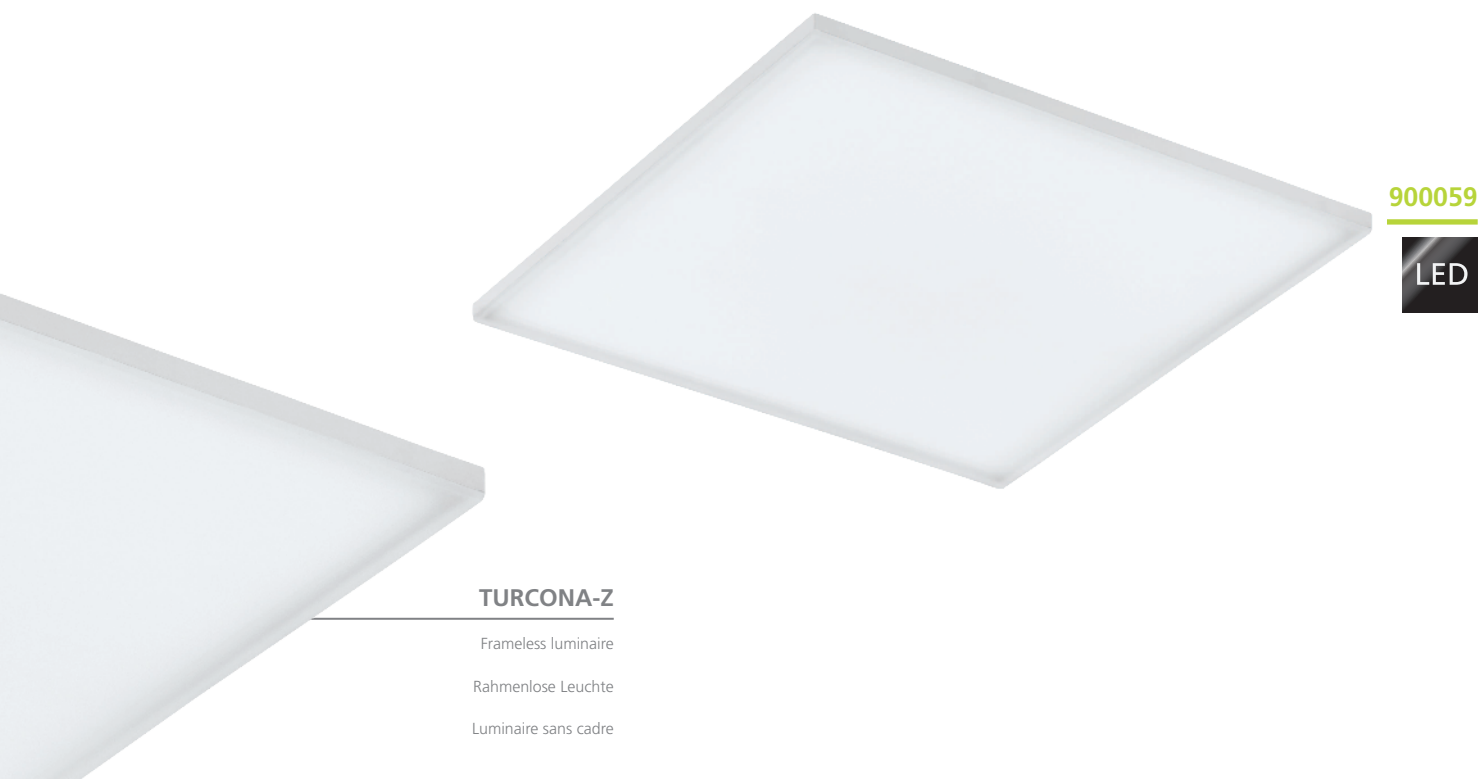

**900059**  
LED

**TURCONA-Z**

Frameless luminaire  
Rahmenlose Leuchte  
Luminaire sans cadre

**900057 TURCONA-Z**

ceiling light; steel, aluminium, white / plastic, white  
Deckenleuchte; Stahl, Alu, weiss / Kunststoff, weiss  
plafonnier; acier, aluminium, blanc / plastique, blanc

L 300, B 300, H 50

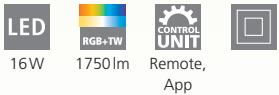

**900058 TURCONA-Z**

ceiling light; steel, aluminium, white / plastic, white  
Deckenleuchte; Stahl, Alu, weiss / Kunststoff, weiss  
plafonnier; acier, aluminium, blanc / plastique, blanc

L 450, B 450, H 70



**900059 TURCONA-Z**

ceiling light; steel, aluminium, white / plastic, white  
Deckenleuchte; Stahl, Alu, weiss / Kunststoff, weiss  
plafonnier; acier, aluminium, blanc / plastique, blanc

L 600, B 600, H 75

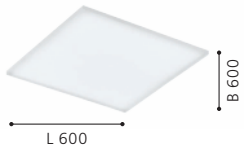
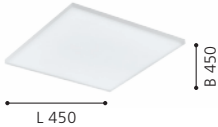
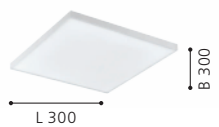



900062

LED



900061

LED

### 900062 TURCONA-Z

ceiling light; steel, aluminium, white / plastic, white  
Deckenleuchte; Stahl, Alu, weiss / Kunststoff, weiss  
plafonnier; acier, aluminium, blanc / plastique, blanc

L 1200, B 100, H 50



34,2W



3910lm



Remote,  
App



### 900061 TURCONA-Z

ceiling light; steel, aluminium, white / plastic, white  
Deckenleuchte; Stahl, Alu, weiss / Kunststoff, weiss  
plafonnier; acier, aluminium, blanc / plastique, blanc

L 1200, B 300, H 50



3x 10,6W



4000lm



Remote,  
App



9 008606 221974



9 008606 221967

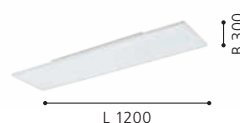





900044



900045



900046



### 900044 SALOBRENA-Z

ceiling light; aluminium, white / plastic, white  
Deckenleuchte; Alu, weiss / Kunststoff, weiss  
plafonnier; aluminium, blanc / plastique, blanc

L 300, B 300, H 50



15,3W 1790lm Remote, App

### 900045 SALOBRENA-Z

ceiling light; aluminium, white / plastic, white  
Deckenleuchte; Alu, weiss / Kunststoff, weiss  
plafonnier; aluminium, blanc / plastique, blanc

L 450, B 450, H 50

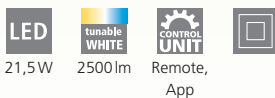

21,5W 2500lm Remote, App

### 900046 SALOBRENA-Z

ceiling light; aluminium, white / plastic, white  
Deckenleuchte; Alu, weiss / Kunststoff, weiss  
plafonnier; aluminium, blanc / plastique, blanc

L 595, B 595, H 50



33W 4100lm Remote, App

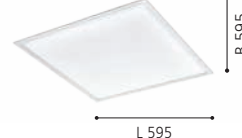
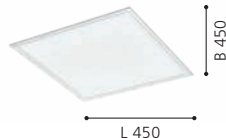
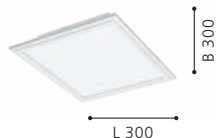



900047

LED



900048

LED



### 900047 SALOBRENA-Z

ceiling light; aluminium, white / plastic, white  
Deckenleuchte; Alu, weiss / Kunststoff, weiss  
plafonnier; aluminium, blanc / plastique, blanc

L 1200, B 300, H 50



33,5W 4150lm Remote, App



### 900048 SALOBRENA-Z

ceiling light; aluminium, white / plastic, white  
Deckenleuchte; Alu, weiss / Kunststoff, weiss  
plafonnier; aluminium, blanc / plastique, blanc

L 1200, B 100, H 45



33,5W 4150lm Remote, App



Zubehör inkludiert  
Accessoires inclus



900049



900051



900052



### 900049 SALOBRENA-Z

ceiling light; aluminium, black / plastic, white  
Deckenleuchte; Alu, schwarz / Kunststoff, weiss  
plafonnier; aluminium, noir / plastique, blanc

L 300, B 300, H 50

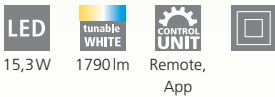

15,3W 1790lm Remote, App



9 008606 221868



### 900051 SALOBRENA-Z

ceiling light; aluminium, black / plastic, white  
Deckenleuchte; Alu, schwarz / Kunststoff, weiss  
plafonnier; aluminium, noir / plastique, blanc

L 450, B 450, H 50



21,5W 2500lm Remote, App



9 008606 221875



### 900052 SALOBRENA-Z

ceiling light; aluminium, black / plastic, white  
Deckenleuchte; Alu, schwarz / Kunststoff, weiss  
plafonnier; aluminium, noir / plastique, blanc

L 595, B 595, H 50

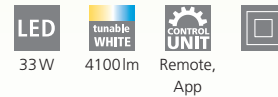

33W 4100lm Remote, App



9 008606 221882





900053



900095



### 900053 SALOBRENA-Z

ceiling light; aluminium, black / plastic, white  
 Deckenleuchte; Alu, schwarz / Kunststoff, weiss  
 plafonnier; aluminium, noir / plastique, blanc

L 1200, B 300, H 50

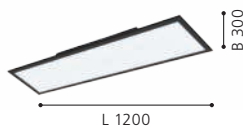

### 900095 SALOBRENA-Z

ceiling light; aluminium, steel, black / plastic, white  
 Deckenleuchte; Alu, Stahl, schwarz / Kunststoff, weiss  
 plafonnier; aluminium, acier, noir / plastique, blanc

L 1200, B 100, H 45

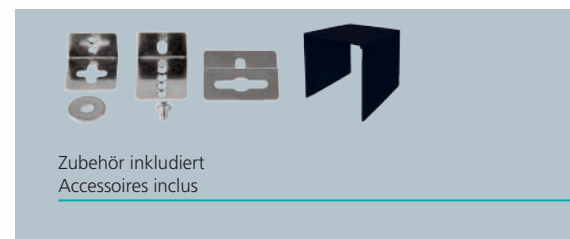
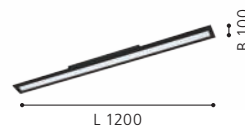

Zubehör inkludiert  
 Accessoires inclus



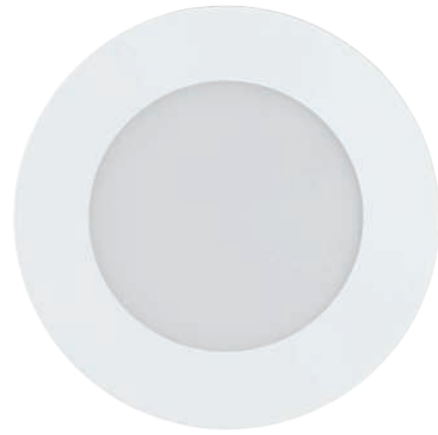

900099



900101



900102



### 900099 FUEVA-Z

recessed light; steel, white / plastic, white  
Einbauleuchte; Stahl, weiss / Kunststoff, weiss  
luminaire encastrable; acier, blanc / plastique, blanc

H 26, Ø 85



3x 2,8W 3x 390lm Remote, App Ø75 IP20, IP44



9 008606 225569



Ø 85

### 900101 FUEVA-Z

recessed light; steel, white / plastic, white  
Einbauleuchte; Stahl, weiss / Kunststoff, weiss  
luminaire encastrable; acier, blanc / plastique, blanc

H 26, Ø 120



5,4W 800lm Remote, App Ø105 IP20, IP44



9 008606 225576



Ø 120

### 900102 FUEVA-Z

recessed light; steel, white / plastic, white  
Einbauleuchte; Stahl, weiss / Kunststoff, weiss  
luminaire encastrable; acier, blanc / plastique, blanc

H 26, Ø 165



10,5W 1520lm Remote, App Ø155 IP20, IP44



9 008606 225583



Ø 165

98842

LED



### 98842 FUEVA-Z

recessed light; aluminium, white / plastic, white  
Einbauleuchte; Alu, weiss / Kunststoff, weiss  
luminaire encastrable; aluminium, blanc / plastique, blanc

Ø 216, ET 26



16,5W



2100lm



Remote,  
App



Ø205



IP20, IP44



9 002759 988425



Ø 216



900112



900111



900113



### 900111 FUEVA-Z

recessed light; steel, satin nickel / plastic, white  
Einbauleuchte; Stahl, nickel-matt / Kunststoff, weiss  
luminaire encastrable; acier, nickel mat / plastique, blanc

H 26, Ø 85



3x 2,8W



3x 390lm



Remote, App



Ø 75



IP20, IP44



Ø 85

### 900112 FUEVA-Z

recessed light; steel, satin nickel / plastic, white  
Einbauleuchte; Stahl, nickel-matt / Kunststoff, weiss  
luminaire encastrable; acier, nickel mat / plastique, blanc

H 26, Ø 120



5,4W



800lm



Remote, App



Ø 105



IP20, IP44



Ø 120

### 900113 FUEVA-Z

recessed light; steel, satin nickel / plastic, white  
Einbauleuchte; Stahl, nickel-matt / Kunststoff, weiss  
luminaire encastrable; acier, nickel mat / plastique, blanc

H 26, Ø 165



10,5W



1520lm



Remote, App



Ø 155



IP20, IP44



Ø 165



98844

LED

**98844 FUEVA-Z**

recessed light; aluminium, satin nickel / plastic, white  
 Einbauleuchte; Alu, nickel-matt / Kunststoff, weiss  
 luminaire encastrable; aluminium, nickel mat / plastique, blanc

Ø 216, ET 26

-  LED  
16,5W
-  tunable  
WHITE  
2100lm
-  CONTROL  
UNIT  
Remote,  
App
-  Ø 205
-  IP20, IP44







900105



900106



98846



### 900105 FUEVA-Z

recessed light; steel, black / plastic, white  
Einbauleuchte; Stahl, schwarz / Kunststoff, weiss  
luminaire encastrable; acier, noir / plastique, blanc

H 26, Ø 85



### 900106 FUEVA-Z

recessed light; steel, black / plastic, white  
Einbauleuchte; Stahl, schwarz / Kunststoff, weiss  
luminaire encastrable; acier, noir / plastique, blanc

H 26, Ø 120



### 98846 FUEVA-Z

recessed light; aluminium, black / plastic, white  
Einbauleuchte; Alu, schwarz / Kunststoff, weiss  
luminaire encastrable; aluminium, noir / plastique, blanc

Ø 216, ET 26





900107

LED

### 900107 FUEVA-Z

recessed light; steel, black / plastic, white

Einbauleuchte; Stahl, schwarz / Kunststoff, weiss

luminaire encastrable; acier, noir / plastique, blanc

H 26, Ø 165



10,5W



1520lm



Remote,  
App



Ø 155



IP20, IP44



9 008606 225637



Ø 165



900104

LED



900103

LED



98849

LED

### 900104 FUEVA-Z

surface-mounted light; steel, white / plastic, white  
Aufbauleuchte; Stahl, weiss / Kunststoff, weiss  
luminaire en saillie; acier, blanc / plastique, blanc

L 210, B 210, H 28



16,5W



2250lm



Remote,  
App



IP44



### 98849 FUEVA-Z

surface-mounted light; aluminium, white / plastic, white  
Aufbauleuchte; Alu, weiss / Kunststoff, weiss  
luminaire en saillie; aluminium, blanc / plastique, blanc

L 285, B 285, H 28



19,5W



2500lm



Remote,  
App



IP44



### 900103 FUEVA-Z

surface-mounted light; steel, white / plastic, white  
Aufbauleuchte; Stahl, weiss / Kunststoff, weiss  
luminaire en saillie; acier, blanc / plastique, blanc

H 28, Ø 210



16,5W



2250lm



Remote,  
App



IP44



9 008606 225606

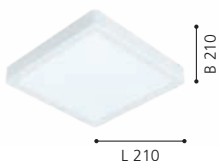

9 002759 988494

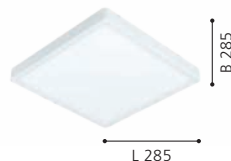

9 008606 225590

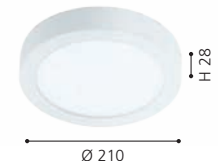



**98843 FUEVA-Z**

surface-mounted light; aluminium, white / plastic, white  
 Aufbauleuchte; Alu, weiss / Kunststoff, weiss  
 luminaire en saillie; aluminium, blanc / plastique, blanc

H 28, Ø 285

- LED  
19,5W
- tunable  
WHITE  
2500lm
- CONTROL  
UNIT  
Remote,  
App
- IP44
- 



98843







900114



900115



98845



### 900114 FUEVA-Z

surface-mounted light; steel, satin nickel / plastic, white  
Aufbauleuchte; Stahl, nickel-matt / Kunststoff, weiss  
luminaire en saillie; acier, nickel mat / plastique, blanc

H 28, Ø 210



16,5W



2250lm



Remote,  
App



IP44



### 98845 FUEVA-Z

surface-mounted light; aluminium, satin nickel / plastic, white  
Aufbauleuchte; Alu, nickel-matt / Kunststoff, weiss  
luminaire en saillie; aluminium, nickel mat / plastique, blanc

H 28, Ø 285



19,5W



2500lm



Remote,  
App



IP44



### 900115 FUEVA-Z

surface-mounted light; steel, satin nickel / plastic, white  
Aufbauleuchte; Stahl, nickel-matt / Kunststoff, weiss  
luminaire en saillie; acier, nickel mat / plastique, blanc

L 210, B 210, H 28



16,5W



2250lm



Remote,  
App



IP44



9 008606 225699



9 002759 988456



9 008606 225705

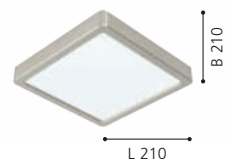





### 98852 FUEVA-Z

surface-mounted light; aluminium, satin nickel / plastic, white  
Aufbauleuchte; Alu, nickel-matt / Kunststoff, weiss  
luminaire en saillie; aluminium, nickel mat / plastique, blanc

L 285, B 285, H 28

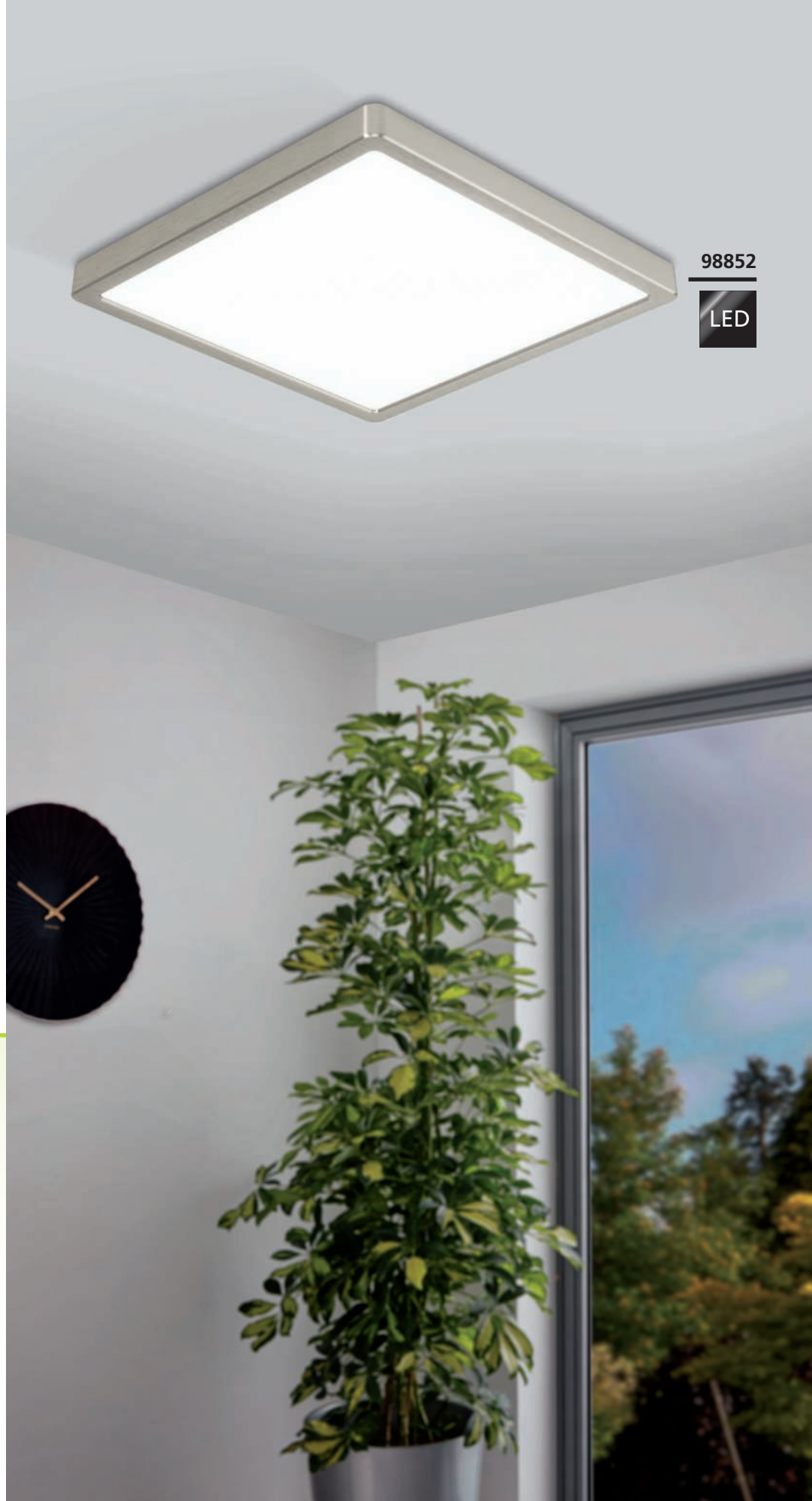
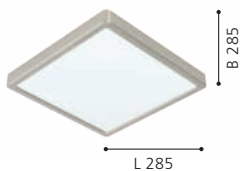
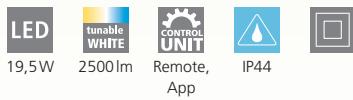

98852





900108



98854



98847



### 900108 FUEVA-Z

surface-mounted light; steel, black / plastic, white  
Aufbauleuchte; Stahl, schwarz / Kunststoff, weiss  
luminaire en saillie; acier, noir / plastique, blanc

H 28, Ø 210



16,5W



2250lm



Remote,  
App



IP44



### 98847 FUEVA-Z

surface-mounted light; aluminium, black / plastic, white  
Aufbauleuchte; Alu, schwarz / Kunststoff, weiss  
luminaire en saillie; aluminium, noir / plastique, blanc

H 28, Ø 285



19,5W



2500lm



Remote,  
App



IP44



### 98854 FUEVA-Z

surface-mounted light; aluminium, black / plastic, white  
Aufbauleuchte; Alu, schwarz / Kunststoff, weiss  
luminaire en saillie; aluminium, noir / plastique, blanc

L 285, B 285, H 28



19,5W



2500lm



Remote,  
App



IP44



9 008606 225644



9 002759 988470



9 002759 988548





900109

LED

### 900109 FUEVA-Z

surface-mounted light; steel, black / plastic, white  
 Aufbauleuchte; Stahl, schwarz / Kunststoff, weiss  
 luminaire en saillie; acier, noir / plastique, blanc

L 210, B 210, H 28



16,5W



2250lm



Remote,  
App



IP44

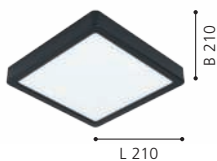



900088



900086



900089



### ROVITO-Z

These lights have individually controllable light settings on the inside and outside of the frame.

Diese Leuchten verfügen über individuell steuerbare Lichteinstellungen der Rahmen innen und außen.

Ces lumières ont des paramètres d'éclairage contrôlables individuellement du cadre.

### 900088 ROVITO-Z

ceiling light; plastic, white / plastic, white  
Deckenleuchte; Kunststoff, weiss / Kunststoff, weiss  
plafonnier; plastique, blanc / plastique, blanc

L 295, B 295, H 25

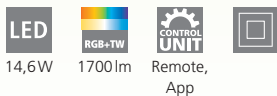

14,6W

1700lm

Remote,  
App

### 900089 ROVITO-Z

ceiling light; plastic, white / plastic, white  
Deckenleuchte; Kunststoff, weiss / Kunststoff, weiss  
plafonnier; plastique, blanc / plastique, blanc

L 420, B 420, H 25



16,5W

2200lm

Remote,  
App

### 900086 ROVITO-Z

ceiling light; plastic, white / plastic, white  
Deckenleuchte; Kunststoff, weiss / Kunststoff, weiss  
plafonnier; plastique, blanc / plastique, blanc

H 25, Ø 295



14,6W

1700lm

Remote,  
App



9 008606 225491



L 295



9 008606 225507



L 420



9 008606 225477



Ø 295





## 900087 ROVITO-Z

ceiling light; plastic, white / plastic, white

Deckenleuchte; Kunststoff, weiss / Kunststoff, weiss

plafonnier; plastique, blanc / plastique, blanc

H 25, Ø 420



16,5W



2200lm



Remote,  
App



9 008606 225484







900093



900092



900094



### ROVITO-Z

These lights have individually controllable light settings on the inside and outside of the frame.

Diese Leuchten verfügen über individuell steuerbare Lichteinstellungen der Rahmen innen und außen.

Ces lumières ont des paramètres d'éclairage contrôlables individuellement du cadre.

### 900093 ROVITO-Z

ceiling light; plastic, black / plastic, white  
Deckenleuchte; Kunststoff, schwarz / Kunststoff, weiss  
plafonnier; plastique, noir / plastique, blanc

L 295, B 295, H 25

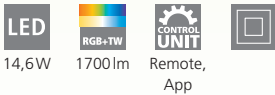

14,6W 1700lm Remote, App

### 900094 ROVITO-Z

ceiling light; plastic, black / plastic, white  
Deckenleuchte; Kunststoff, schwarz / Kunststoff, weiss  
plafonnier; plastique, noir / plastique, blanc

L 420, B 420, H 25

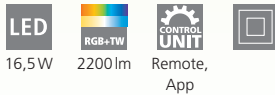

16,5W 2200lm Remote, App

### 900092 ROVITO-Z

ceiling light; plastic, black / plastic, white  
Deckenleuchte; Kunststoff, schwarz / Kunststoff, weiss  
plafonnier; plastique, noir / plastique, blanc

H 25, Ø 420

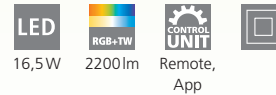

16,5W 2200lm Remote, App

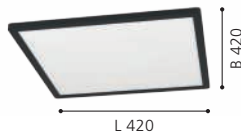
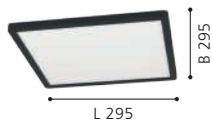



900091



### 900091 ROVITO-Z

ceiling light; plastic, black / plastic, white

Deckenleuchte; Kunststoff, schwarz / Kunststoff, weiss

plafonnier; plastique, noir / plastique, blanc

H 25, Ø 295



14,6W



1700lm



Remote,  
App



9 008606 225514



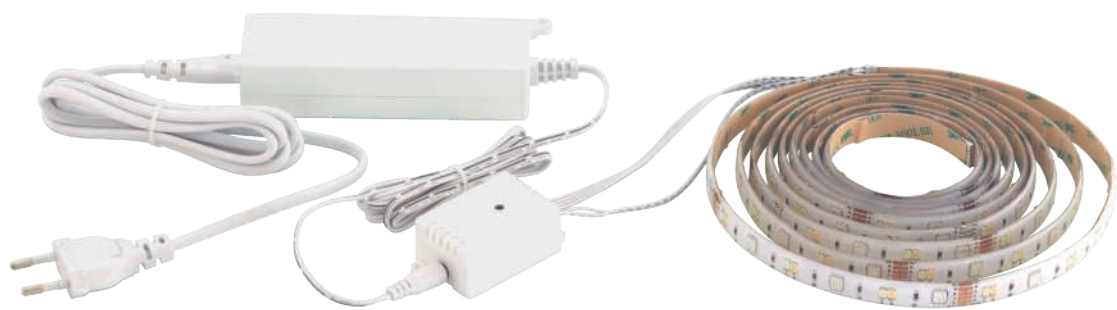

99686

99687

LED



99684

99685

LED

99684

Driver included

Treiber inkludiert

Chauffeur inclus



1x 1,5 m

99685

Extension for starter set 99684 without driver

Erweiterung für Starterset 99684 ohne Treiber

Rallonge pour kit de démarrage 99684 sans pilote

99686, 99687

Driver included

Treiber inkludiert

Chauffeur inclus



1x 1,5 m



### 99686 LED STRIPE-Z

bar / strip light; plastic, white  
Leuchtband/-stab; Kunststoff, weiss  
bande lumineuse / bâton l; plastique, blanc

L 5000, B 10



11W



1250lm



Remote,  
App



### 99687 LED STRIPE-Z

bar / strip light; plastic, white  
Leuchtband/-stab; Kunststoff, weiss  
bande lumineuse / bâton l; plastique, blanc

L 8000, B 12, H 3



8x 3W



2640lm



Remote,  
App



### 99684 LED STRIPE-Z

bar / strip light; plastic, white  
Leuchtband/-stab; Kunststoff, weiss  
bande lumineuse / bâton l; plastique, blanc

L 3000, B 8



13,5W



1450lm



Remote,  
App



9 002759 996864



L 5000



9 002759 996871



L 8000



9 002759 996840



L 3000



99687



**99685 LED STRIPE-Z**

bar / strip light; plastic, white  
 Leuchtband/-stab; Kunststoff, weiss  
 bande lumineuse / bâton l; plastique, blanc

L 2000, B 8



9W



950lm



Remote,  
App



9 002759 996857

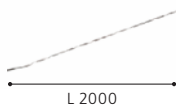





## EGLO CONNECT.Z ILLUMINANT

One illuminant – numerous possibilities: 16.7 million colours and over 50,000 white tones ensure the right atmosphere in your home at all times. The illuminant can be controlled via remote control or app using Bluetooth technology: You can control the brightness or adjust colour tones – and all this without complicated installation and comfortably from the sofa.

But the illuminant can do much more: it can be expanded at will using intelligent mesh technology, and up to 50 illuminants can be grouped together. This makes it easy to create and program a wide variety of lighting scenarios. You can also use the app to select from a large number of pre-set lighting scenes.

Security is not neglected either, as the illuminants form a self-contained network and are therefore protected from external access.

## EGLO CONNECT.Z LEUCHTMITTEL

Ein Leuchtmittel – zahlreiche Möglichkeiten: 16,7 Millionen Farben und über 50.000 Weißtöne sorgen jederzeit für die richtige Stimmung in Ihrem Heim. Über die Bluetooth-Technologie kann das Leuchtmittel per Fernbedienung oder App gesteuert werden: Sie können die Helligkeit kontrollieren oder Farbtöne einstellen – und das alles ohne aufwändige Installation und bequem vom Sofa aus.

Aber das Leuchtmittel kann noch viel mehr: es lässt sich per intelligenter Mesh-Technologie beliebig erweitern, bis zu 50 Leuchtmittel sind hierbei gruppierbar. So lassen sich problemlos und einfach unterschiedlichste Lichtszenarien erstellen und programmieren. Mit der App können Sie aber auch aus einer Vielzahl vorgegebener Lichtstimmungen auswählen.

Auch die Sicherheit kommt nicht zu kurz, denn die Leuchtmittel bilden ein in sich geschlossenes Netzwerk und sind somit vor Zugriffen von Außen geschützt.

## AMPOULE EGLO CONNECT.Z

Une seule ampoule – de nombreuses possibilités : 16,7 millions de couleurs et plus de 50 000 tons de blanc assurent à tout moment la bonne ambiance dans votre maison. L'ampoule peut être commandée via une télécommande ou une appli, utilisant la technologie Bluetooth : Vous pouvez contrôler la luminosité ou régler les tons de couleurs – et tout cela sans installation compliquée et de manière confortablement depuis votre canapé.

Mais l'ampoule peut faire beaucoup plus : elle peut être étendue à volonté grâce à la technologie Mesh intelligentes, et jusqu'à 50 ampoules peuvent être regroupées. Il est ainsi facile de créer et de programmer une grande variété de scène lumineuse. Vous pouvez également utiliser l'appli pour sélectionner un grand nombre d'ambiance lumineuse prédéfinies.

La sécurité n'est pas négligée non plus, car les ampoules forment un réseau fermé et sont donc protégées des accès externes.

## 12253 E27-LED-A60

<b>Dimensions</b> Abmessungen / Dimensions	L 118, Ø 60
<b>Socket</b> Sockel / Douille	E27
<b>Wattage</b> Wattage / Puissance	9 W
<b>Light Colour</b> Lichtfarbe / Couleur lumineuse	2765 K
<b>Operating voltage</b> Betriebsspannung / Tension de fonctionnement	220-240V 50/60Hz
<b>Lifetime</b> Lebensdauer / Durée de vie	15000 h
<b>Colour rendering index</b> Farbwiedergabeindex / L'indice de restitution de couleurs	80



## 12254 E27-LED-G95

<b>Dimensions</b> Abmessungen / Dimensions	L 142, Ø 95
<b>Socket</b> Sockel / Douille	E27
<b>Wattage</b> Wattage / Puissance	13,5 W
<b>Light Colour</b> Lichtfarbe / Couleur lumineuse	2765 K
<b>Operating voltage</b> Betriebsspannung / Tension de fonctionnement	220-240V 50/60Hz
<b>Lifetime</b> Lebensdauer / Durée de vie	15000 h
<b>Colour rendering index</b> Farbwiedergabeindex / L'indice de restitution de couleurs	80



## 12252 E14-LED-P45

<b>Dimensions</b> Abmessungen / Dimensions	L 92, Ø 45
<b>Socket</b> Sockel / Douille	E14
<b>Wattage</b> Wattage / Puissance	4,9 W
<b>Light Colour</b> Lichtfarbe / Couleur lumineuse	2765 K
<b>Operating voltage</b> Betriebsspannung / Tension de fonctionnement	220-240V 50/60Hz
<b>Lifetime</b> Lebensdauer / Durée de vie	15000 h
<b>Colour rendering index</b> Farbwiedergabeindex / L'indice de restitution de couleurs	80



## 12251 GU10-LED

<b>Dimensions</b> Abmessungen / Dimensions	L 59, Ø 50
<b>Socket</b> Sockel / Douille	GU10
<b>Wattage</b> Wattage / Puissance	4,9 W
<b>Light Colour</b> Lichtfarbe / Couleur lumineuse	2765 K
<b>Operating voltage</b> Betriebsspannung / Tension de fonctionnement	220-240V 50/60Hz
<b>Lifetime</b> Lebensdauer / Durée de vie	15000 h
<b>Colour rendering index</b> Farbwiedergabeindex / L'indice de restitution de couleurs	83
<b>Beamangle</b> Ausstrahlwinkel / Angle de rayonnement	45°



## 12226 E27-LED-A60

<b>Dimensions</b> Abmessungen / Dimensions	L 105, Ø 60
<b>Socket</b> Sockel / Douille	E27
<b>Wattage</b> Wattage / Puissance	6 W
<b>Light Colour</b> Lichtfarbe / Couleur lumineuse	2700 K
<b>Operating voltage</b> Betriebsspannung / Tension de fonctionnement	220-240V 50/60Hz
<b>Lifetime</b> Lebensdauer / Durée de vie	15000 h
<b>Colour rendering index</b> Farbwiedergabeindex / L'indice de restitution de couleurs	80



**6 W**

**806 lm**  
LUMEN

A+ E warm WHITE

6 W ~ 60 W



9 002759 122263

## 12227 E27-LED-ST64

<b>Dimensions</b> Abmessungen / Dimensions	L 142, Ø 64
<b>Socket</b> Sockel / Douille	E27
<b>Wattage</b> Wattage / Puissance	6 W
<b>Light Colour</b> Lichtfarbe / Couleur lumineuse	2700 K
<b>Operating voltage</b> Betriebsspannung / Tension de fonctionnement	220-240V 50/60Hz
<b>Lifetime</b> Lebensdauer / Durée de vie	15000 h
<b>Colour rendering index</b> Farbwiedergabeindex / L'indice de restitution de couleurs	80



**6 W**

**806 lm**  
LUMEN

A+ E warm WHITE

6 W ~ 60 W



9 002759 122270

## 12228 E27-LED-G80

<b>Dimensions</b> Abmessungen / Dimensions	L 120, Ø 80
<b>Socket</b> Sockel / Douille	E27
<b>Wattage</b> Wattage / Puissance	6 W
<b>Light Colour</b> Lichtfarbe / Couleur lumineuse	2700 K
<b>Operating voltage</b> Betriebsspannung / Tension de fonctionnement	220-240V 50/60Hz
<b>Lifetime</b> Lebensdauer / Durée de vie	15000 h
<b>Colour rendering index</b> Farbwiedergabeindex / L'indice de restitution de couleurs	80



**6 W**

**806 lm**  
LUMEN

A+ E warm WHITE

6 W ~ 60 W



9 002759 122287

## 12229 E27-LED-G95

<b>Dimensions</b> Abmessungen / Dimensions	L 140, Ø 95
<b>Socket</b> Sockel / Douille	E27
<b>Wattage</b> Wattage / Puissance	6 W
<b>Light Colour</b> Lichtfarbe / Couleur lumineuse	2700 K
<b>Operating voltage</b> Betriebsspannung / Tension de fonctionnement	220-240V 50/60Hz
<b>Lifetime</b> Lebensdauer / Durée de vie	15000 h
<b>Colour rendering index</b> Farbwiedergabeindex / L'indice de restitution de couleurs	80



6 W

806 lm  
LUMEN



## 12231 E27-LED-A60

<b>Dimensions</b> Abmessungen / Dimensions	L 105, Ø 60
<b>Socket</b> Sockel / Douille	E27
<b>Wattage</b> Wattage / Puissance	6 W
<b>Light Colour</b> Lichtfarbe / Couleur lumineuse	4000 K
<b>Operating voltage</b> Betriebsspannung / Tension de fonctionnement	220-240V 50/60Hz
<b>Lifetime</b> Lebensdauer / Durée de vie	15000 h
<b>Colour rendering index</b> Farbwiedergabeindex / L'indice de restitution de couleurs	80



6 W

806 lm  
LUMEN



## 12232 E27-LED-ST64

<b>Dimensions</b> Abmessungen / Dimensions	L 142, Ø 64
<b>Socket</b> Sockel / Douille	E27
<b>Wattage</b> Wattage / Puissance	6 W
<b>Light Colour</b> Lichtfarbe / Couleur lumineuse	4000 K
<b>Operating voltage</b> Betriebsspannung / Tension de fonctionnement	220-240V 50/60Hz
<b>Lifetime</b> Lebensdauer / Durée de vie	15000 h
<b>Colour rendering index</b> Farbwiedergabeindex / L'indice de restitution de couleurs	80



6 W

806 lm  
LUMEN





## 12233 E27-LED-G80

<b>Dimensions</b> Abmessungen / Dimensions	L 120, Ø 80
<b>Socket</b> Sockel / Douille	E27
<b>Wattage</b> Wattage / Puissance	6 W
<b>Light Colour</b> Lichtfarbe / Couleur lumineuse	4000 K
<b>Operating voltage</b> Betriebsspannung / Tension de fonctionnement	220-240V 50/60Hz
<b>Lifetime</b> Lebensdauer / Durée de vie	15000 h
<b>Colour rendering index</b> Farbwiedergabeindex / L'indice de restitution de couleurs	80



6 W  
**806 lm**  
LUMEN



## 12234 E27-LED-G95

<b>Dimensions</b> Abmessungen / Dimensions	L 140, Ø 95
<b>Socket</b> Sockel / Douille	E27
<b>Wattage</b> Wattage / Puissance	6 W
<b>Light Colour</b> Lichtfarbe / Couleur lumineuse	4000 K
<b>Operating voltage</b> Betriebsspannung / Tension de fonctionnement	220-240V 50/60Hz
<b>Lifetime</b> Lebensdauer / Durée de vie	15000 h
<b>Colour rendering index</b> Farbwiedergabeindex / L'indice de restitution de couleurs	80



6 W  
**806 lm**  
LUMEN



## 12235 E27-LED-A60

<b>Dimensions</b> Abmessungen / Dimensions	L 105, Ø 60
<b>Socket</b> Sockel / Douille	E27
<b>Wattage</b> Wattage / Puissance	6 W
<b>Light Colour</b> Lichtfarbe / Couleur lumineuse	2265 K
<b>Operating voltage</b> Betriebsspannung / Tension de fonctionnement	220-240V 50/60Hz
<b>Lifetime</b> Lebensdauer / Durée de vie	15000 h
<b>Colour rendering index</b> Farbwiedergabeindex / L'indice de restitution de couleurs	80



6 W  
**806 lm**  
LUMEN



## 12236 E27-LED-ST64

<b>Dimensions</b> Abmessungen / Dimensions	L 142, Ø 64
<b>Socket</b> Sockel / Douille	E27
<b>Wattage</b> Wattage / Puissance	6 W
<b>Light Colour</b> Lichtfarbe / Couleur lumineuse	2265 K
<b>Operating voltage</b> Betriebsspannung / Tension de fonctionnement	220-240V 50/60Hz
<b>Lifetime</b> Lebensdauer / Durée de vie	15000 h
<b>Colour rendering index</b> Farbwiedergabeindex / L'indice de restitution de couleurs	80



6 W

806 lm  
LUMEN



## 12237 E27-LED-G80

<b>Dimensions</b> Abmessungen / Dimensions	L 120, Ø 80
<b>Socket</b> Sockel / Douille	E27
<b>Wattage</b> Wattage / Puissance	6 W
<b>Light Colour</b> Lichtfarbe / Couleur lumineuse	2265 K
<b>Operating voltage</b> Betriebsspannung / Tension de fonctionnement	220-240V 50/60Hz
<b>Lifetime</b> Lebensdauer / Durée de vie	15000 h
<b>Colour rendering index</b> Farbwiedergabeindex / L'indice de restitution de couleurs	80



6 W

806 lm  
LUMEN



## 12239 E27-LED-G95

<b>Dimensions</b> Abmessungen / Dimensions	L 140, Ø 95
<b>Socket</b> Sockel / Douille	E27
<b>Wattage</b> Wattage / Puissance	6 W
<b>Light Colour</b> Lichtfarbe / Couleur lumineuse	2265 K
<b>Operating voltage</b> Betriebsspannung / Tension de fonctionnement	220-240V 50/60Hz
<b>Lifetime</b> Lebensdauer / Durée de vie	15000 h
<b>Colour rendering index</b> Farbwiedergabeindex / L'indice de restitution de couleurs	80



6 W

806 lm  
LUMEN



## 12221 E27-LED-A60

<b>Dimensions</b> Abmessungen / Dimensions	L 105, Ø 60
<b>Socket</b> Sockel / Douille	E27
<b>Wattage</b> Wattage / Puissance	4,9 W
<b>Light Colour</b> Lichtfarbe / Couleur lumineuse	2200 K
<b>Operating voltage</b> Betriebsspannung / Tension de fonctionnement	220-240V 50/60Hz
<b>Lifetime</b> Lebensdauer / Durée de vie	15000 h
<b>Colour rendering index</b> Farbwiedergabeindex / L'indice de restitution de couleurs	80



**4,9 W**

**500 lm**  
LUMEN

**A+ F** warm WHITE

4,9 W ~ 41 W

9 002759 122218

## 12222 E27-LED-ST64

<b>Dimensions</b> Abmessungen / Dimensions	L 142, Ø 64
<b>Socket</b> Sockel / Douille	E27
<b>Wattage</b> Wattage / Puissance	4,9 W
<b>Light Colour</b> Lichtfarbe / Couleur lumineuse	2200 K
<b>Operating voltage</b> Betriebsspannung / Tension de fonctionnement	220-240V 50/60Hz
<b>Lifetime</b> Lebensdauer / Durée de vie	15000 h
<b>Colour rendering index</b> Farbwiedergabeindex / L'indice de restitution de couleurs	80



**4,9 W**

**500 lm**  
LUMEN

**A+ F** warm WHITE

4,9 W ~ 41 W

9 002759 122225

## 12223 E27-LED-G80

<b>Dimensions</b> Abmessungen / Dimensions	L 120, Ø 80
<b>Socket</b> Sockel / Douille	E27
<b>Wattage</b> Wattage / Puissance	4,9 W
<b>Light Colour</b> Lichtfarbe / Couleur lumineuse	2200 K
<b>Operating voltage</b> Betriebsspannung / Tension de fonctionnement	220-240V 50/60Hz
<b>Lifetime</b> Lebensdauer / Durée de vie	15000 h
<b>Colour rendering index</b> Farbwiedergabeindex / L'indice de restitution de couleurs	80



**4,9 W**

**500 lm**  
LUMEN

**A+ F** warm WHITE

4,9 W ~ 41 W

9 002759 122232

## 12224 E27-LED-G95

<b>Dimensions</b> Abmessungen / Dimensions	L 140, Ø 95
<b>Socket</b> Sockel / Douille	E27
<b>Wattage</b> Wattage / Puissance	4,9 W
<b>Light Colour</b> Lichtfarbe / Couleur lumineuse	2200 K
<b>Operating voltage</b> Betriebsspannung / Tension de fonctionnement	220-240V 50/60Hz
<b>Lifetime</b> Lebensdauer / Durée de vie	15000 h
<b>Colour rendering index</b> Farbwiedergabeindex / L'indice de restitution de couleurs	80



4,9 W

**500 lm**  
LUMEN



4,9 W



41 W



## 12225 E27-LED-G125

<b>Dimensions</b> Abmessungen / Dimensions	L 172, Ø 125
<b>Socket</b> Sockel / Douille	E27
<b>Wattage</b> Wattage / Puissance	6 W
<b>Light Colour</b> Lichtfarbe / Couleur lumineuse	2200 K
<b>Operating voltage</b> Betriebsspannung / Tension de fonctionnement	220-240V 50/60Hz
<b>Lifetime</b> Lebensdauer / Durée de vie	15000 h
<b>Colour rendering index</b> Farbwiedergabeindex / L'indice de restitution de couleurs	80



6 W

**650 lm**  
LUMEN



6 W



50 W



## 12241 E27-LED-A60

<b>Dimensions</b> Abmessungen / Dimensions	L 105, Ø 60
<b>Socket</b> Sockel / Douille	E27
<b>Wattage</b> Wattage / Puissance	4,9 W
<b>Light Colour</b> Lichtfarbe / Couleur lumineuse	2265 K
<b>Operating voltage</b> Betriebsspannung / Tension de fonctionnement	220-240V 50/60Hz
<b>Lifetime</b> Lebensdauer / Durée de vie	15000 h
<b>Colour rendering index</b> Farbwiedergabeindex / L'indice de restitution de couleurs	80



4,9 W  
**360 lm**  
LUMEN



## 12242 E27-LED-ST64

<b>Dimensions</b> Abmessungen / Dimensions	L 142, Ø 64
<b>Socket</b> Sockel / Douille	E27
<b>Wattage</b> Wattage / Puissance	4,9 W
<b>Light Colour</b> Lichtfarbe / Couleur lumineuse	2265 K
<b>Operating voltage</b> Betriebsspannung / Tension de fonctionnement	220-240V 50/60Hz
<b>Lifetime</b> Lebensdauer / Durée de vie	15000 h
<b>Colour rendering index</b> Farbwiedergabeindex / L'indice de restitution de couleurs	80



4,9 W  
**360 lm**  
LUMEN



## 12243 E27-LED-G80

<b>Dimensions</b> Abmessungen / Dimensions	L 120, Ø 80
<b>Socket</b> Sockel / Douille	E27
<b>Wattage</b> Wattage / Puissance	4,9 W
<b>Light Colour</b> Lichtfarbe / Couleur lumineuse	2265 K
<b>Operating voltage</b> Betriebsspannung / Tension de fonctionnement	220-240V 50/60Hz
<b>Lifetime</b> Lebensdauer / Durée de vie	15000 h
<b>Colour rendering index</b> Farbwiedergabeindex / L'indice de restitution de couleurs	80



4,9 W  
**360 lm**  
LUMEN





## 12244 E27-LED-G95

<b>Dimensions</b> Abmessungen / Dimensions	L 140, Ø 95
<b>Socket</b> Sockel / Douille	E27
<b>Wattage</b> Wattage / Puissance	4,9 W
<b>Light Colour</b> Lichtfarbe / Couleur lumineuse	2265 K
<b>Operating voltage</b> Betriebsspannung / Tension de fonctionnement	220-240V 50/60Hz
<b>Lifetime</b> Lebensdauer / Durée de vie	15000 h
<b>Colour rendering index</b> Farbwiedergabeindex / L'indice de restitution de couleurs	80



## 12245 E27-LED-G125

<b>Dimensions</b> Abmessungen / Dimensions	L 170, Ø 125
<b>Socket</b> Sockel / Douille	E27
<b>Wattage</b> Wattage / Puissance	4,9 W
<b>Light Colour</b> Lichtfarbe / Couleur lumineuse	2265 K
<b>Operating voltage</b> Betriebsspannung / Tension de fonctionnement	220-240V 50/60Hz
<b>Lifetime</b> Lebensdauer / Durée de vie	15000 h
<b>Colour rendering index</b> Farbwiedergabeindex / L'indice de restitution de couleurs	80



## 12255 E27-LED-A60

<b>Dimensions</b> Abmessungen / Dimensions	L 105, Ø 60
<b>Socket</b> Sockel / Douille	E27
<b>Wattage</b> Wattage / Puissance	6 W
<b>Light Colour</b> Lichtfarbe / Couleur lumineuse	4000 K
<b>Operating voltage</b> Betriebsspannung / Tension de fonctionnement	220-240V 50/60Hz
<b>Lifetime</b> Lebensdauer / Durée de vie	15000 h
<b>Colour rendering index</b> Farbwiedergabeindex / L'indice de restitution de couleurs	80



incl./inkl./inclus



**6 W**  
**806 lm**  
LUMEN



## 12256 E27-LED-ST64

<b>Dimensions</b> Abmessungen / Dimensions	L 142, Ø 64
<b>Socket</b> Sockel / Douille	E27
<b>Wattage</b> Wattage / Puissance	4,9 W
<b>Light Colour</b> Lichtfarbe / Couleur lumineuse	2200 K
<b>Operating voltage</b> Betriebsspannung / Tension de fonctionnement	220-240V 50/60Hz
<b>Lifetime</b> Lebensdauer / Durée de vie	15000 h
<b>Colour rendering index</b> Farbwiedergabeindex / L'indice de restitution de couleurs	80



incl./inkl./inclus



**4,9 W**  
**500 lm**  
LUMEN



## 12257 E27-LED-A60

<b>Dimensions</b> Abmessungen / Dimensions	L 105, Ø 60
<b>Socket</b> Sockel / Douille	E27
<b>Wattage</b> Wattage / Puissance	6 W
<b>Light Colour</b> Lichtfarbe / Couleur lumineuse	4000 K
<b>Operating voltage</b> Betriebsspannung / Tension de fonctionnement	220-240V 50/60Hz
<b>Lifetime</b> Lebensdauer / Durée de vie	15000 h
<b>Colour rendering index</b> Farbwiedergabeindex / L'indice de restitution de couleurs	80



incl./inkl./inclus



**6 W**  
**806 lm**  
LUMEN



## 12258 E27-LED-ST64

<b>Dimensions</b> Abmessungen / Dimensions	L 142, Ø 64
<b>Socket</b> Sockel / Douille	E27
<b>Wattage</b> Wattage / Puissance	4,9 W
<b>Light Colour</b> Lichtfarbe / Couleur lumineuse	2200 K
<b>Operating voltage</b> Betriebsspannung / Tension de fonctionnement	220-240V 50/60Hz
<b>Lifetime</b> Lebensdauer / Durée de vie	15000 h
<b>Colour rendering index</b> Farbwiedergabeindex / L'indice de restitution de couleurs	80



incl./inkl./inclus

4,9 W

500 lm  
LUMEN



warm  
WHITE



4,9 W



41 W



# EGLO Access

Let **light** follow  
your **life**



# OVERVIEW

EGLO ACCESS



ACCESS REMOTE  
p. 102



ZUBIETA-A  
p. 102-104



SILERAS-A  
p. 105



FRANIA-A  
p. 106-107



MORATICA-A  
p. 107



SARSINA-A  
p. 108



SALOBRENA-A  
p. 110-111



FUEVA-A  
p. 112



This product is available in different colors and shapes./ Dieser Artikel ist in unterschiedlichen Farben und Formen verfügbar.  
Cet article est disponible en différentes couleurs et formes.



# FUNCTIONS

## FUNKTIONEN FONCTIONS

Relax with warm light and leave the hustle and bustle of everyday life behind you. Concentrate on your work or dispel fatigue, with neutral white light the energy level is replenished. EGLO Access offers these possibilities and many more. All functions and highlights at a glance:

- › It works with radio frequency technology and allows 360 degree control
- › Controllable up to a distance of 10 meters
- › Up to 8 different items can be connected
- › Easy handling thanks to 4 ready-made settings and 2 memory functions

NIGHT LIGHT

RELAX MODE

WORK MODE

SWITCH OFF AFTER 30 MINUTES

Mit warmem Licht entspannen und die Hektik des Alltages hinter sich lassen. Konzentriert arbeiten oder die Müdigkeit vertreiben, mit neutralweißem Licht wird das Energielevel wieder aufgefüllt. Diese Möglichkeiten und noch viele mehr bietet Ihnen EGLO Access. Alle Funktionen und Highlights auf einem Blick:

- › Es arbeitet mit Funktechnologie und ermöglicht eine 360-Grad-Steuerung
- › Steuerbar bis zu einer Entfernung von 10 Metern
- › Bis zu 8 verschiedene Artikel können miteinander verbunden werden
- › Einfache Handhabung durch 4 vorgefertigte Einstellungen und 2 Speicherfunktionen

NACHTLICHT

ENTSPANNUNGSMODUS

ARBEITSMODUS

AUSSCHALTEN NACH 30 MINUTEN

Lumière chaude pour se détendre et laisser l'agitation quotidienne derrière soi. Travailler de manière concentrée ou chasser la fatigue, avec une lumière blanche neutre, le niveau d'énergie est rétabli. EGLO Access vous offre ces possibilités et bien d'autres encore. Toutes les fonctions et les points forts en un coup d'œil :

- › Il fonctionne avec la technologie de la fréquence radio et permet un contrôle à 360 degrés
- › Contrôlable jusqu'à une distance de 10 mètres
- › Jusqu'à 8 articles différents peuvent être connectés ensemble
- › Manipulation facile grâce à 4 réglages prêts à l'emploi et 2 fonctions mémoire

VEILLEUSE

MODE DE DÉCOMPRESSION

MODE DE TRAVAIL

EXTINCTION APRÈS 30 MINUTES

## COLOUR TEMPERATURES SCALE / FARBTEMPERATUREN SKALA / ÉCHELLE DES TEMPÉRATURES DE COULEUR



# REMOTE CONTROL

FERNBEDIENUNG  
TÉLÉCOMMANDE

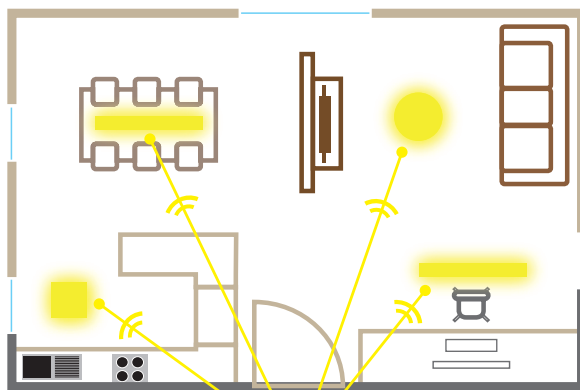
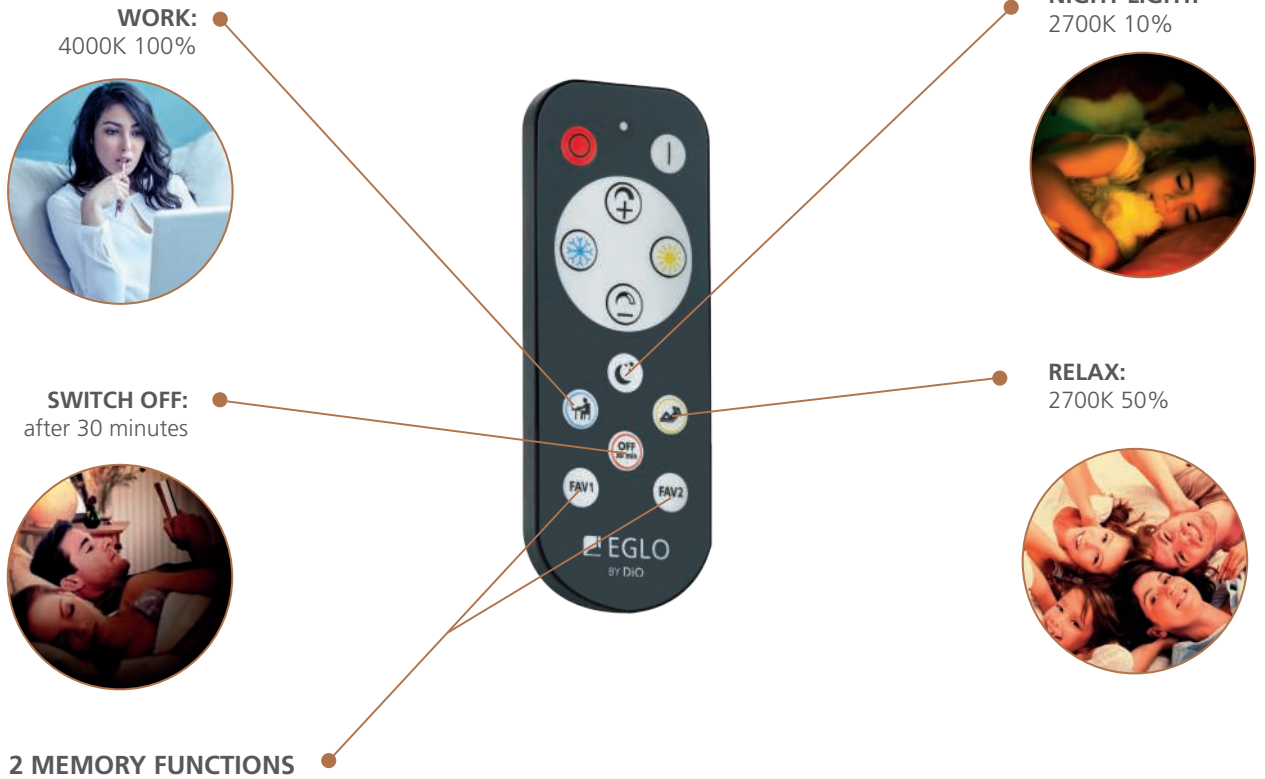

no internet necessary  
kein Internet erforderlich  
nul besoin d'internet



Control up to 8 EGLO Access luminaires  
Bis zu 8 EGLO Access Leuchten steuerbar  
Contrôle jusqu'à 8 luminaires EGLO Access



98894

LED

incl./inkl./inclus



33199



incl./inkl./inclus

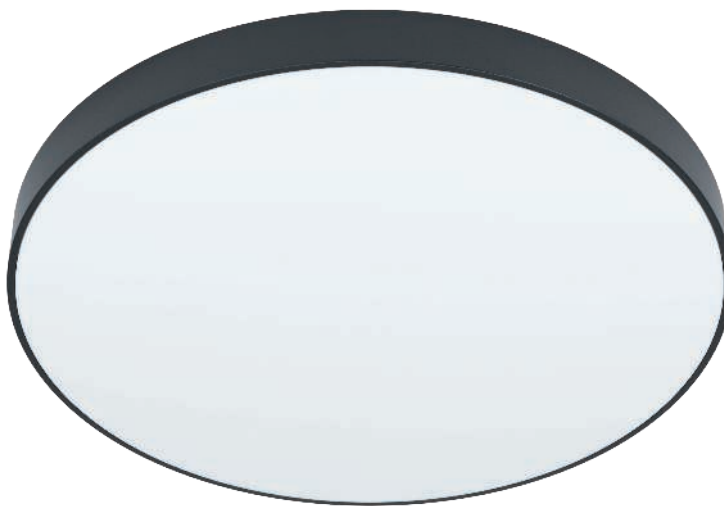

98895

LED

incl./inkl./inclus



### 33199 ACCESS REMOTE

remote control; plastic, anthracite  
Fernbedienung; Kunststoff, anthrazit  
Télécommande; plastique, gris anthracite

L 118, B 45



ACCU  
CR2032



9 002759 331993



### 98894 ZUBIETA-A

surface-mounted light; steel, black / plastic, white  
Aufbauleuchte; Stahl, schwarz / Kunststoff, weiss  
luminaire en saillie; acier, noir / plastique, blanc

H 40, Ø 300



18W



tunable  
WHITE  
1900lm



Remote



9 002759 988944



### 98895 ZUBIETA-A

surface-mounted light; steel, black / plastic, white  
Aufbauleuchte; Stahl, schwarz / Kunststoff, weiss  
luminaire en saillie; acier, noir / plastique, blanc

H 40, Ø 450



24W



tunable  
WHITE  
2300lm



Remote



9 002759 988951





98896

LED

incl./inkl./inclus



### 98896 ZUBIETA-A

surface-mounted light; steel, black / plastic, white  
Aufbauleuchte; Stahl, schwarz / Kunststoff, weiss  
luminaire en saillie; acier, noir / plastique, blanc

H 40, Ø 595

LED

36W

tunable  
WHITE

3700lm



CONTROL  
UNIT

Remote



9 002759 988968



SURFACE

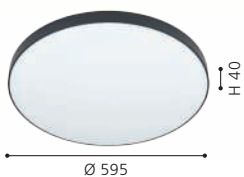



98892



98891



98893



### 98891 ZUBIETA-A

surface-mounted light; steel, white / plastic, white  
Aufbauleuchte; Stahl, weiss / Kunststoff, weiss  
luminaire en saillie; acier, blanc / plastique, blanc

H 40, Ø 300



18W



1900lm



Remote

### 98892 ZUBIETA-A

surface-mounted light; steel, white / plastic, white  
Aufbauleuchte; Stahl, weiss / Kunststoff, weiss  
luminaire en saillie; acier, blanc / plastique, blanc

H 40, Ø 450



24W



2300lm



Remote

### 98893 ZUBIETA-A

surface-mounted light; steel, white / plastic, white  
Aufbauleuchte; Stahl, weiss / Kunststoff, weiss  
luminaire en saillie; acier, blanc / plastique, blanc

H 40, Ø 595



36W



3700lm



Remote



9 002759 988913



9 002759 988920

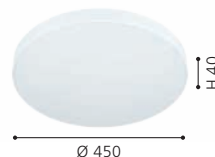

9 002759 988937

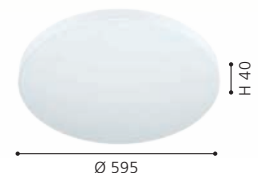





98227



98228

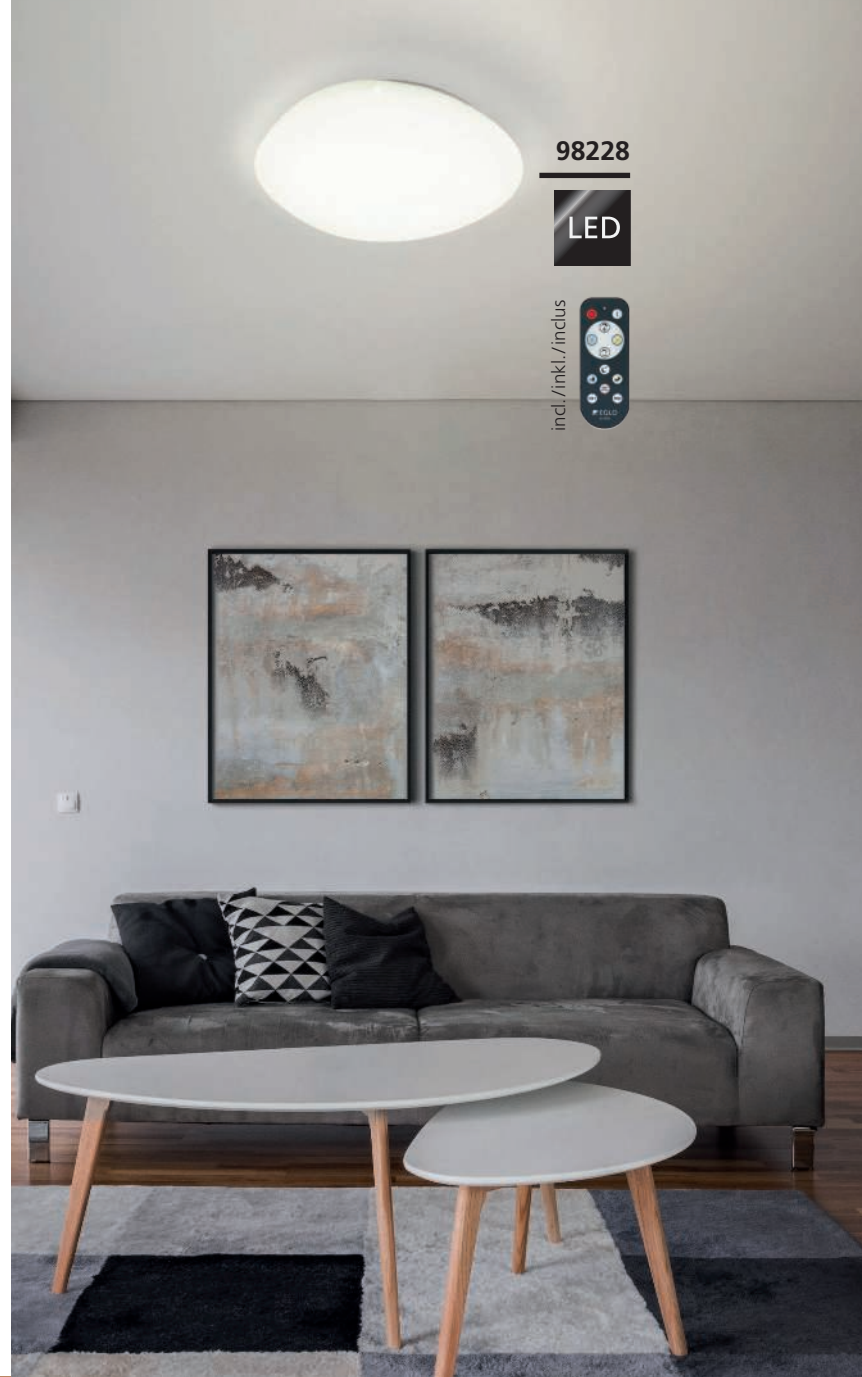

**98227 SILERAS-A**

wall / ceiling light; steel, white / plastic with crystal effect, white  
 Wand- / Deckenleuchte; Stahl, weiss / Kunststoff m.Kristalleffekt, weiss  
 applique / plafonnier; acier, blanc / plastique avec effet cristal, blanc

H 80, Ø 450



**98228 SILERAS-A**

wall / ceiling light; steel, white / plastic with crystal effect, white  
 Wand- / Deckenleuchte; Stahl, weiss / Kunststoff m.Kristalleffekt, weiss  
 applique / plafonnier; acier, blanc / plastique avec effet cristal, blanc

H 85, Ø 600





98294

LED



incl./inkl./inclus



98236

LED



incl./inkl./inclus



98237

LED



incl./inkl./inclus

### 98294 FRANIA-A

wall / ceiling light; steel, white / plastic with crystal effect, white  
Wand- / Deckenleuchte; Stahl, weiss / Kunststoff m.Kristalleffekt, weiss  
applique / plafonnier; acier, blanc / plastique avec effet cristal, blanc

H 55, Ø 300



12 W



1050 lm



Remote



IP44

### 98236 FRANIA-A

wall / ceiling light; steel, white / plastic with crystal effect, white  
Wand- / Deckenleuchte; Stahl, weiss / Kunststoff m.Kristalleffekt, weiss  
applique / plafonnier; acier, blanc / plastique avec effet cristal, blanc

H 55, Ø 400



19 W



2400 lm



Remote

### 98237 FRANIA-A

wall / ceiling light; steel, white / plastic with crystal effect, white  
Wand- / Deckenleuchte; Stahl, weiss / Kunststoff m.Kristalleffekt, weiss  
applique / plafonnier; acier, blanc / plastique avec effet cristal, blanc

H 75, Ø 570



32,5 W



3900 lm



Remote



9 002759 982942



9 002759 982362

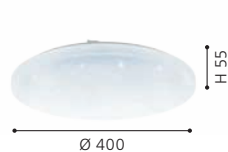

9 002759 982379

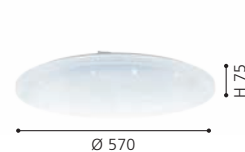



98219

LED



incl./inkl./inclus



98235

LED



incl./inkl./inclus



### 98235 FRANIA-A

wall / ceiling light; steel, white / plastic, white  
Wand- / Deckenleuchte; Stahl, weiss / Kunststoff, weiss  
applique / plafonnier; acier, blanc / plastique, blanc

H 55, Ø 300



12W

1050lm

Remote

### 98219 MORATICA-A

ceiling light; steel, plastic, white, transparent / plastic with  
crystal effect, white, silver  
Deckenleuchte; Stahl, Kunststoff, weiss, transparent / Kunststoff  
m.Kristalleffekt, weiss, silber  
plafonnier; acier, plastique, blanc, transparent / plastique avec  
effet cristal, blanc, argent  
H 75, Ø 570



32,5W

3900lm

Remote



9 002759 982355

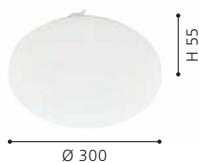

9 002759 982195





98207



98208



**98207 SARSINA-A**

ceiling light; aluminium, white / plastic, white  
Deckenleuchte; Alu, weiss / Kunststoff, weiss  
plafonnier; aluminium, blanc / plastique, blanc

H 50, Ø 300



**98208 SARSINA-A**

ceiling light; aluminium, white / plastic, white  
Deckenleuchte; Alu, weiss / Kunststoff, weiss  
plafonnier; aluminium, blanc / plastique, blanc

H 50, Ø 450



**98209 SARSINA-A**

ceiling light; aluminium, white / plastic, white  
Deckenleuchte; Alu, weiss / Kunststoff, weiss  
plafonnier; aluminium, blanc / plastique, blanc

H 50, Ø 600

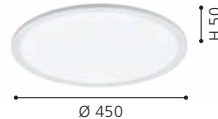



98209

LED

incl./inkl./inclus







98205



98206



### 98205 SALOBRENA-A

ceiling light; aluminium, white / plastic, white  
Deckenleuchte; Alu, weiss / Kunststoff, weiss  
plafonnier; aluminium, blanc / plastique, blanc

L 1200, B 300, H 50



### 98206 SALOBRENA-A

ceiling light; aluminium, white / plastic, white  
Deckenleuchte; Alu, weiss / Kunststoff, weiss  
plafonnier; aluminium, blanc / plastique, blanc

L 1195, B 100, H 50



### 98297 SALOBRENA-A

ceiling light; aluminium, white / plastic, white  
Deckenleuchte; Alu, weiss / Kunststoff, weiss  
plafonnier; aluminium, blanc / plastique, blanc

L 450, B 450, H 50



9 002759 982058

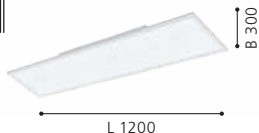

9 002759 982065



9 002759 982973

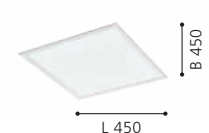



98297



98201



98203



### 98201 SALOBRENA-A

ceiling light; aluminium, white / plastic, white  
Deckenleuchte; Alu, weiss / Kunststoff, weiss  
plafonnier; aluminium, blanc / plastique, blanc

L 300, B 300, H 50



### 98203 SALOBRENA-A

ceiling light; aluminium, white / plastic, white  
Deckenleuchte; Alu, weiss / Kunststoff, weiss  
plafonnier; aluminium, blanc / plastique, blanc

L 600, B 600, H 50



9 002759 982010

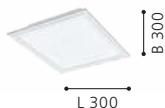

9 002759 982034

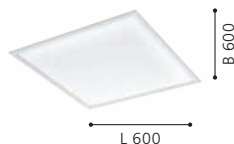



98292



FUEVA-A

These luminaires inspire with their extremely flat and elegant design.

Diese Leuchten begeistern durch ihre extrem flache und elegante Bauweise.

Ces lumières enthousiasment par la méthode de construction extrêmement plate et élégante.



98293



### 98292 FUEVA-A

surface-mounted light; aluminium, white / plastic, white  
 Aufbauleuchte; Alu, weiss / Kunststoff, weiss  
 luminaire en saillie; aluminium, blanc / plastique, blanc

H 30, Ø 225



### 98293 FUEVA-A

surface-mounted light; aluminium, white / plastic, white  
 Aufbauleuchte; Alu, weiss / Kunststoff, weiss  
 luminaire en saillie; aluminium, blanc / plastique, blanc

H 30, Ø 300



### 98212 FUEVA-A

recessed light; aluminium, white / plastic, white  
 Einbauleuchte; Alu, weiss / Kunststoff, weiss  
 luminaire encastrable; aluminium, blanc / plastique, blanc

Ø 120, ET 30





98212

LED

incl./inkl./inclus



# LIGHTING FAMILIES

FABRIC LUMINAIRES

STOFFLEUCHTEN

LUMINAIRES À TEXTIL

## SIMPLE CLASSINESS

The textile luminaires with their unusual designs are perfectly trendy and bring cosiness to every home. Selected textiles in natural shades and clear shapes form the basis of a friendly and tasteful living environment in our textile luminaires. Inner coatings in sophisticated gold and classical silver add an air of luxury.

## SCHLICHTE ELEGANZ

Die Stoffleuchten mit ihrem außergewöhnlichen Design sind voll im Trend und sorgen für Gemütlichkeit in jedem Zuhause. Bei den Stoffleuchten bilden ausgesuchte Stoffe in Naturtönen und klare Formgebungen die Grundlage für eine freundliche und geschmackvolle Wohnumgebung. Für einen Hauch von Luxus sorgen die Innenbeschichtungen in edlem Gold und klassischem Silber.



## ÉLÉGANCE SIMPLE

Les luminaires en étoffe avec leur design extraordinaire sont très tendance et assurent un confort dans chaque maison. Chez les luminaires en étoffe, des étoffes sélectionnées dans des tons naturels et des formes claires forment la base d'un cadre de vie convivial et de bon goût. Les revêtements internes en or fin et en argent classique ajoutent une touche de luxe.





# OVERVIEW

LIGHTING FAMILIES / FABRIC



This product is available in different colors and shapes./ Dieser Artikel ist in unterschiedlichen Farben und Formen verfügbar.  
Cet article est disponible en différentes couleurs et formes.





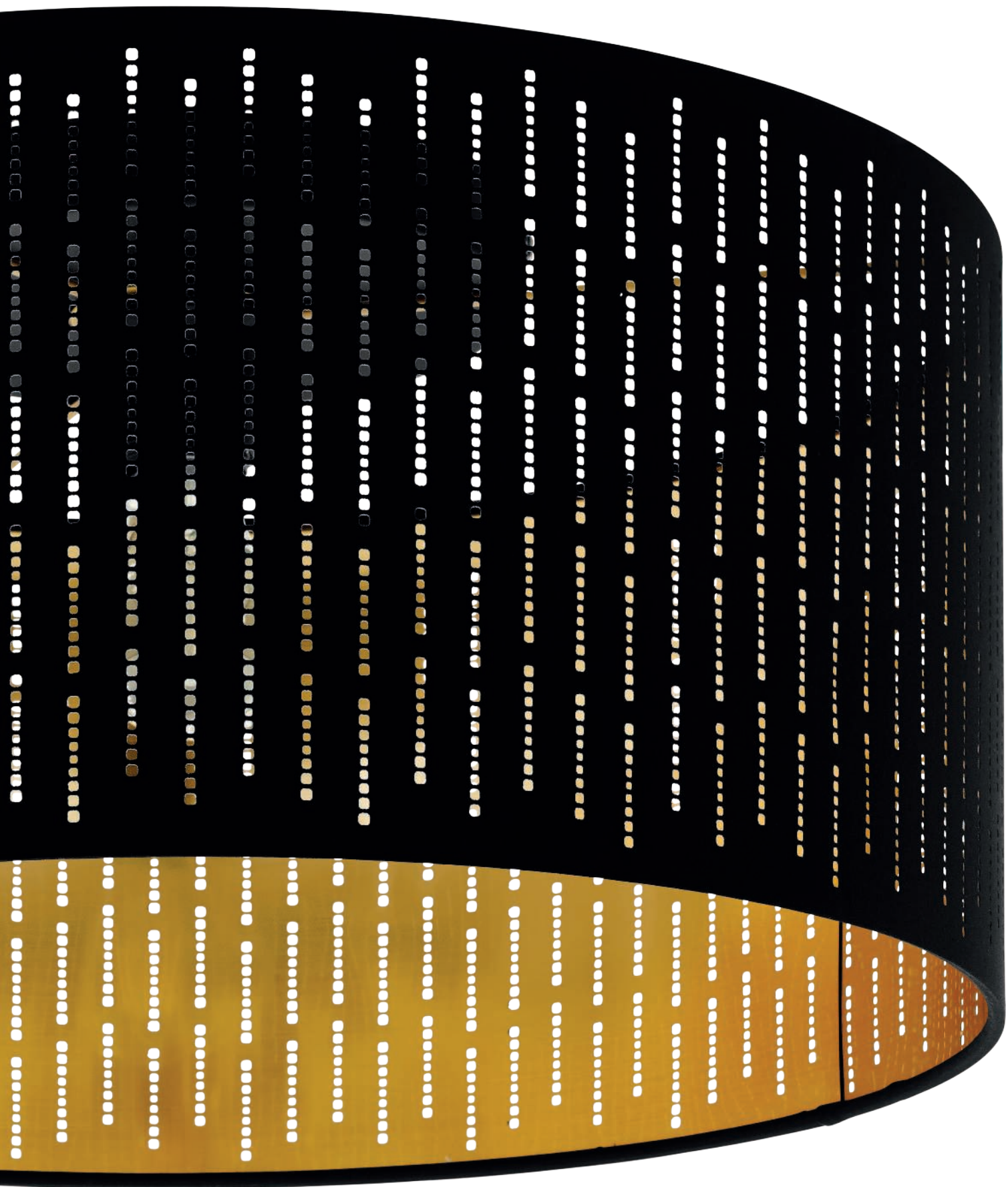

# FABRIC MATERIALS

## COATING



coating, silver  
Beschichtung, silber  
revêtement, argent

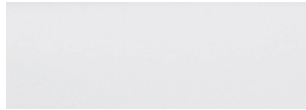

coating, white  
Beschichtung, weiß  
revêtement, blanc



coating, black  
Beschichtung, schwarz  
revêtement, noir



coating, gold  
Beschichtung, gold  
revêtement, or



coating, copper  
Beschichtung, kupfer  
revêtement, cuivre



coating, brass  
Beschichtung, messing  
revêtement, laiton



coating, brass & white  
Beschichtung, messing & weiß  
revêtement, laiton & blanc

## SHADES

### GLOSSY



fabric, glossy black  
Textil, samtglänzend schwarz  
tissu, velours noir brillant



fabric, glossy cappuccino  
Textil, samtglänzend cappuccino  
tissu, velours cappuccino brillant



fabric, glossy white  
Textil, samtglänzend weiß  
tissu, velours blanc brillant

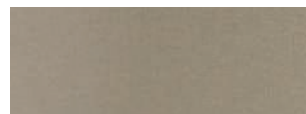

fabric, glossy taupe  
Textil, samtglänzend taupe  
tissu, velours taupe brillant



fabric, glossy grey  
Textil, samtglänzend grau  
tissu, velours gris brillant



fabric, glossy gold  
Textil, samtglänzend gold  
tissu, velours or brillant

### MAT



fabric, mat black  
Textil, matt schwarz  
tissu, tapis noir

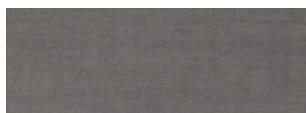

fabric, mat anthracite-brown  
Textil, matt anthrazit-braun  
tissu, tapis anthracite-marron



fabric, mat white  
Textil, matt weiß  
tissu, tapis blanc

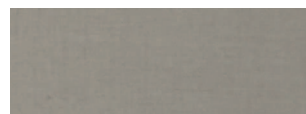

fabric, mat taupe  
Textil, matt taupe  
tissu, tapis taupe



fabric, mat grey  
Textil, matt grau  
tissu, tapis gris



fabric, mat white & gold  
Textil, matt weiß & gold  
tissu, tapis blanc & or

### LINEN

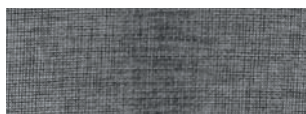

linen, grey  
Leinen, grau  
lin, gris



linen, brown  
Leinen, braun  
lin, marron





97777

LED



97782

LED



97779

LED



### 97777 ROMAO 1

ceiling light; steel, white / fabric, plastic, white  
Deckenleuchte; Stahl, weiss / Textil, Kunststoff, weiss  
plafonnier; acier, blanc / tissu, plastique, blanc

H 120, Ø 570



36W



4300lm



Remote

### 97782 ROMAO 1

ceiling light; steel, white / fabric, plastic, white  
Deckenleuchte; Stahl, weiss / Textil, Kunststoff, weiss  
plafonnier; acier, blanc / tissu, plastique, blanc

H 120, Ø 760



54W



6500lm



Remote

### 97779 ROMAO

ceiling light; steel, white / fabric linen, plastic, grey, white  
Deckenleuchte; Stahl, weiss / Textil Leinen, Kunststoff, grau,  
weiss  
plafonnier; acier, blanc / tissu de lin, plastique, gris, blanc

H 120, Ø 570



36W



4300lm



Remote



9 002759 977771

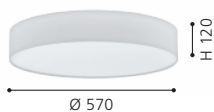

9 002759 977825

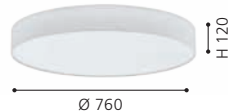

9 002759 977795





97784

LED

incl./inkl./inclus



97783

LED

incl./inkl./inclus



97778

LED

incl./inkl./inclus



 <b>TUNABLE WHITE</b> 3000 - 5000 K	 <b>DIMMABLE</b> 10 - 100 %	 <b>TIMER FUNCTION</b> off after 30sec.	 <b>NIGHT LIGHT FUNCTION</b>	<b>97777</b>	<b>97782</b>
				<b>97778</b>	<b>97783</b>
				<b>97779</b>	<b>97784</b>

see page / siehe Seite / voir la page 454

### 97784 ROMAO

ceiling light; steel, white / fabric linen, plastic, grey, white  
Deckenleuchte; Stahl, weiss / Textil Leinen, Kunststoff, grau, weiss  
plafonnier; acier, blanc / tissu de lin, plastique, gris, blanc

H 120, Ø 760



### 97778 ROMAO 3

ceiling light; steel, white / fabric, plastic, taupe, white  
Deckenleuchte; Stahl, weiss / Textil, Kunststoff, taupe, weiss  
plafonnier; acier, blanc / tissu, plastique, taupe, blanc

H 120, Ø 570



### 97783 ROMAO 3

ceiling light; steel, white / fabric, plastic, taupe, white  
Deckenleuchte; Stahl, weiss / Textil, Kunststoff, taupe, weiss  
plafonnier; acier, blanc / tissu, plastique, taupe, blanc

H 120, Ø 760



9 002759 977849



9 002759 977788

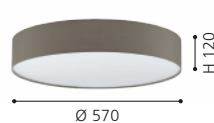

9 002759 977832





### 97611 PASTERI

ceiling light; steel, white / fabric, white  
Deckenleuchte; Stahl, weiss / Textil, weiss  
plafonnier; acier, blanc / tissu, blanc

H 150, Ø 570



### 97615 PASTERI

ceiling light; steel, white / fabric, white  
Deckenleuchte; Stahl, weiss / Textil, weiss  
plafonnier; acier, blanc / tissu, blanc

H 150, Ø 760



### 97619 PASTERI

ceiling light; steel, white / fabric, white  
Deckenleuchte; Stahl, weiss / Textil, weiss  
plafonnier; acier, blanc / tissu, blanc

H 170, Ø 980





### 97613 PASTERI

ceiling light; steel, white / fabric, linen, grey, white  
Deckenleuchte; Stahl, weiss / Textil, Leinen, grau, weiss  
plafonnier; acier, blanc / tissu, lin, gris, blanc

H 150, Ø 570



### 97617 PASTERI

ceiling light; steel, white / fabric, linen, grey, white  
Deckenleuchte; Stahl, weiss / Textil, Leinen, grau, weiss  
plafonnier; acier, blanc / tissu, lin, gris, blanc

H 150, Ø 760



### 97622 PASTERI

ceiling light; steel, white / fabric, linen, grey, white  
Deckenleuchte; Stahl, weiss / Textil, Leinen, grau, weiss  
plafonnier; acier, blanc / tissu, lin, gris, blanc

H 170, Ø 980



DESIGN  
HIGHLIGHT  
DETAIL



97614



97618



### 97614 PASTERI

ceiling light; steel, white / fabric, linen, brown, white  
Deckenleuchte; Stahl, weiss / Textil, Leinen, braun, weiss  
plafonnier; acier, blanc / tissu, lin, marron, blanc

H 150, Ø 570



E27



3x 25W



9 002759 976149



### 97618 PASTERI

ceiling light; steel, white / fabric, linen, brown, white  
Deckenleuchte; Stahl, weiss / Textil, Leinen, braun, weiss  
plafonnier; acier, blanc / tissu, lin, marron, blanc

H 150, Ø 760



E27



5x 25W



9 002759 976187







### 97612 PASTERI

ceiling light; steel, white / fabric, taupe, white  
Deckenleuchte; Stahl, weiss / Textil, taupe, weiss  
plafonnier; acier, blanc / tissu, taupe, blanc

H 150, Ø 570



### 97616 PASTERI

ceiling light; steel, white / fabric, taupe, white  
Deckenleuchte; Stahl, weiss / Textil, taupe, weiss  
plafonnier; acier, blanc / tissu, taupe, blanc

H 150, Ø 760



### 97621 PASTERI

ceiling light; steel, white / fabric, taupe, white  
Deckenleuchte; Stahl, weiss / Textil, taupe, weiss  
plafonnier; acier, blanc / tissu, taupe, blanc

H 170, Ø 980





PASTERI SQUARE  
POSADERRA



**99089**



**99298**

### 99089 PASTERI SQUARE

ceiling light; steel, white / fabric, plastic, white  
Deckenleuchte; Stahl, weiss / Textil, Kunststoff, weiss  
plafonnier; acier, blanc / tissu, plastique, blanc

L 575, B 575, H 165



E27



5x 25W

### 99298 POSADERRA

ceiling light; steel, white / fabric, plastic, white  
Deckenleuchte; Stahl, weiss / Textil, Kunststoff, weiss  
plafonnier; acier, blanc / tissu, plastique, blanc

L 750, B 280, H 150



E27



3x 28W



9 002759 990893

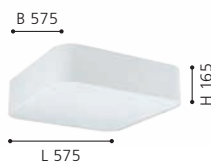

9 002759 992989

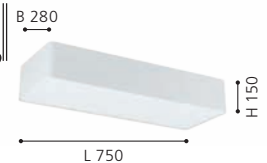



**99091**



**99092**

### 99091 PASTERI SQUARE

ceiling light; steel, white / fabric, plastic, taupe, white  
Deckenleuchte; Stahl, weiss / Textil, Kunststoff, taupe, weiss  
plafonnier; acier, blanc / tissu, plastique, taupe, blanc

L 575, B 575, H 165



E27



5x 25W

### 99092 PASTERI SQUARE

ceiling light; steel, white / fabric, plastic, grey, white  
Deckenleuchte; Stahl, weiss / Textil, Kunststoff, grau, weiss  
plafonnier; acier, blanc / tissu, plastique, gris, blanc

L 575, B 575, H 165



E27



5x 25W



9 002759 990916

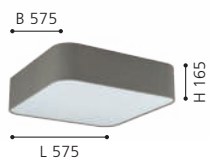

9 002759 990923

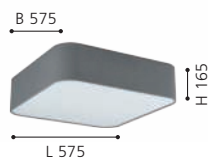



93395

LED



96538

LED



93397

LED

### 93395 PALOMARO

ceiling light; plastic, white / fabric, anthracite  
Deckenleuchte; Kunststoff, weiss / Textil, anthrazit  
plafonnier; plastique, blanc / tissu, anthracite

H 90, Ø 320

LED

warm  
WHITE



3x 3,6W 1110lm

### 96538 PALOMARO 1

ceiling light; plastic, white / fabric, anthracite  
Deckenleuchte; Kunststoff, weiss / Textil, anthrazit  
plafonnier; plastique, blanc / tissu, anthracite

H 100, Ø 405

LED

warm  
WHITE



18W 2000lm

### 93397 PALOMARO

ceiling light; plastic, white / fabric, anthracite  
Deckenleuchte; Kunststoff, weiss / Textil, anthrazit  
plafonnier; plastique, blanc / tissu, anthracite

H 110, Ø 500

LED

warm  
WHITE



4x 5,4W 2200lm



9 002759 933951



9 002759 965389



9 002759 933975

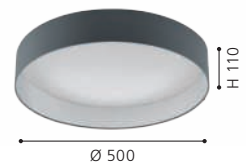



93949



96539



93952



### 93949 PALOMARO

ceiling light; plastic, white / fabric, taupe  
Deckenleuchte; Kunststoff, weiss / Textil, taupe  
plafonnier; plastique, blanc / tissu, taupe

H 90, Ø 320

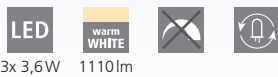

3x 3,6W 1110lm

### 96539 PALOMARO 1

ceiling light; plastic, white / fabric, taupe  
Deckenleuchte; Kunststoff, weiss / Textil, taupe  
plafonnier; plastique, blanc / tissu, taupe

H 100, Ø 405



18W 2000lm

### 93952 PALOMARO

ceiling light; plastic, white / fabric, taupe  
Deckenleuchte; Kunststoff, weiss / Textil, taupe  
plafonnier; plastique, blanc / tissu, taupe

H 110, Ø 500



4x 5,4W 2200lm



9 002759 939496



9 002759 965396



9 002759 939526







**97479**



**97838**



**98409**

### 97479 PASTORE

ceiling light; steel, white / fabric, anthracite-brown, white, grey  
Deckenleuchte; Stahl, weiss / Textil, anthrazit-braun, weiss, grau  
plafonnier; acier, blanc / tissu, marron anthracite, blanc, gris

L 610, B 495, H 255



E27



3x 60W

### 97838 PASTORE

ceiling light; steel, white / fabric, brown, grey, white, black  
Deckenleuchte; Stahl, weiss / Textil, braun, grau, weiss, schwarz  
plafonnier; acier, blanc / tissu, marron, gris, blanc, noir

H 285, Ø 990



E27



6x 40W

### 98409 PASTORE 1

ceiling light; steel, white / fabric, taupe  
Deckenleuchte; Stahl, weiss / Textil, taupe  
plafonnier; acier, blanc / tissu, taupe

H 250, Ø 990



E27



6x 40W



9 002759 974794

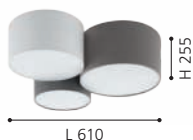

9 002759 978389

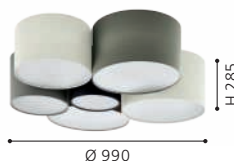

9 002759 984090





99508



99509



PASTORE | PASTORE 1  
PASTORE 2

### 99508 PASTORE 2

ceiling light; steel, white / fabric, black, white  
Deckenleuchte; Stahl, weiss / Textil, schwarz, weiss  
plafonnier; acier, blanc / tissu, noir, blanc

L 610, B 495, H 255



E27



3x 60W



9 002759 995089

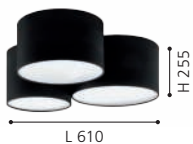

### 99509 PASTORE 2

ceiling light; steel, white / fabric, black, white  
Deckenleuchte; Stahl, weiss / Textil, schwarz, weiss  
plafonnier; acier, blanc / tissu, noir, blanc

H 285, Ø 990



E27



6x 40W



9 002759 995096

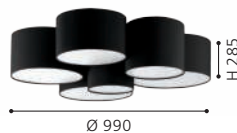

DESIGN  
HIGHLIGHT  
DETAIL



**31581**



**31572**

### 31581 PASTERI

pendant light; steel, satin nickel / fabric, taupe  
 Hängeleuchte; Stahl, nickel-matt / Textil, taupe  
 luminaire en suspension; acier, nickel mat / tissu, taupe

L 750, B 220, H 1100

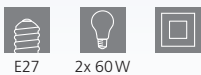

E27 2x 60W

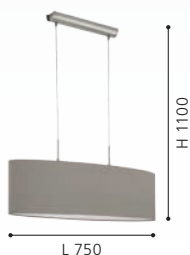

### 31572 PASTERI

pendant light; steel, satin nickel / fabric, taupe  
 Hängeleuchte; Stahl, nickel-matt / Textil, taupe  
 luminaire en suspension; acier, nickel mat / tissu, taupe

H 1100, Ø 380



E27 1x 60W



### 31589 PASTERI

ceiling light; plastic, steel, white / fabric, taupe  
 Deckenleuchte; Kunststoff, Stahl, weiss / Textil, taupe  
 plafonnier; plastique, acier, blanc / tissu, taupe

H 90, Ø 320



LED 3x 11W  
 warm WHITE 3x 950lm





31589

LED



31576

### 31576 PASTERI

pendant light; steel, satin nickel / fabric, taupe  
Hängeleuchte; Stahl, nickel-matt / Textil, taupe  
luminaire en suspension; acier, nickel mat / tissu, taupe

H 1100, Ø 530



E27



1x 60W



9 002759 315764





94919



94919



94925



96478



### 94919 PASTERI

ceiling light; steel, satin nickel / fabric, glass, taupe  
Deckenleuchte; Stahl, nickel-matt / Textil, Glas, taupe  
plafonnier; acier, nickel mat / tissu, verre, taupe

H 195, Ø 475



### 94925 PASTERI

wall light; steel, satin nickel / fabric, taupe  
Wandleuchte; Stahl, nickel-matt / Textil, taupe  
applique; acier, nickel mat / tissu, taupe

L 145, H 305, A 195

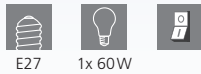

### 96478 PASTERI

wall light; steel, satin nickel / fabric, taupe  
Wandleuchte; Stahl, nickel-matt / Textil, taupe  
applique; acier, nickel mat / tissu, taupe

L 150, H 380, A 195

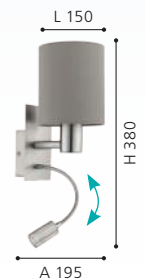





**95122**



**95122**

These luminaires can be switched on and off by touching the specially designed "Touch Me" part of the fixture.

Diese Leuchten können ein- und ausgeschaltet werden, indem man sie an den dafür vorgesehenen "Touch Me" Bereichen berührt.

Ces luminaires peuvent être éteints et allumés simplement en touchant la partie spécialement conçue pour "Touch Me" du luminaire.



**31595**



**95167**

### 95122 PASTERI

table light; steel, satin nickel / fabric, taupe  
Tischleuchte; Stahl, nickel-matt / Textil, taupe  
luminaire de table; acier, nickel mat / tissu, taupe

H 255, Ø 120



E27 1x 40W



9 002759 951221



### 31595 PASTERI

table light; steel, satin nickel / fabric, taupe  
Tischleuchte; Stahl, nickel-matt / Textil, taupe  
luminaire de table; acier, nickel mat / tissu, taupe

H 400, Ø 180

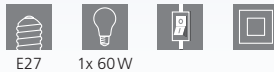

E27 1x 60W



9 002759 315955



### 95167 PASTERI

floor light; steel, satin nickel / fabric, taupe  
Stehleuchte; Stahl, nickel-matt / Textil, taupe  
lampadaire; acier, nickel mat / tissu, taupe

H 1575, Ø 280, Base: Ø 230



E27 1x 60W



9 002759 951672

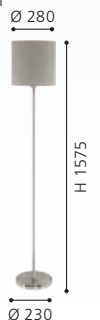



**31582**



**31592**

LED



**31586**

### 31582 PASTERI

pendant light; steel, satin nickel / fabric, grey  
Hängeleuchte; Stahl, nickel-matt / Textil, grau  
luminaire en suspension; acier, nickel mat / tissu, gris

L 750, B 220, H 1100

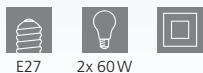

E27 2x 60W



9 002759 315825

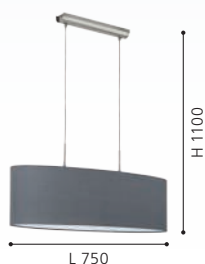

### 31586 PASTERI

pendant light; steel, satin nickel / fabric, grey  
Hängeleuchte; Stahl, nickel-matt / Textil, grau  
luminaire en suspension; acier, nickel mat / tissu, gris

L 1000, B 280, H 1100

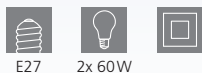

E27 2x 60W



9 002759 315863



### 31592 PASTERI

ceiling light; plastic, steel, white / fabric, grey  
Deckenleuchte; Kunststoff, Stahl, weiss / Textil, grau  
plafonnier; plastique, acier, blanc / tissu, gris

H 90, Ø 320



LED warm WHITE 3x 3,6W 1110lm



9 002759 315924





### 94921 PASTERI

ceiling light; steel, satin nickel / fabric, glass, grey  
Deckenleuchte; Stahl, nickel-matt / Textil, Glas, grau  
plafonnier; acier, nickel mat / tissu, verre, gris

H 195, Ø 475

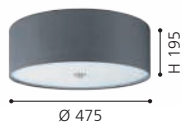

### 31577 PASTERI

pendant light; steel, satin nickel / fabric, grey  
Hängeleuchte; Stahl, nickel-matt / Textil, grau  
luminaire en suspension; acier, nickel mat / tissu, gris

H 1100, Ø 530



### 31573 PASTERI

pendant light; steel, satin nickel / fabric, grey  
Hängeleuchte; Stahl, nickel-matt / Textil, grau  
luminaire en suspension; acier, nickel mat / tissu, gris

H 1100, Ø 380





**94926**



**96479**

**LED**

**94926 PASTERI**

wall light; steel, satin nickel / fabric, grey  
 Wandleuchte; Stahl, nickel-matt / Textil, grau  
 applique; acier, nickel mat / tissu, gris

L 145, H 305, A 195

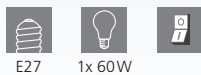

**96479 PASTERI**

wall light; steel, satin nickel / fabric, grey  
 Wandleuchte; Stahl, nickel-matt / Textil, grau  
 applique; acier, nickel mat / tissu, gris

L 150, H 380, A 195

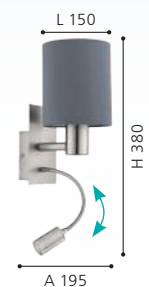



**95119**



**95119**

These luminaires can be switched on and off by touching the specially designed "Touch Me" part of the fixture.

Diese Leuchten können ein- und ausgeschaltet werden, indem man sie an den dafür vorgesehenen "Touch Me" Bereichen berührt.

Ces luminaires peuvent être éteints et allumés simplement en touchant la partie spécialement conçue pour "Touch Me" du luminaire.



**31596**



**95166**

### 95119 PASTERI

table light; steel, satin nickel / fabric, grey  
Tischleuchte; Stahl, nickel-matt / Textil, grau  
luminaire de table; acier, nickel mat / tissu, gris

H 255, Ø 120



E27 1x 40W



9 002759 951191



### 31596 PASTERI

table light; steel, satin nickel / fabric, grey  
Tischleuchte; Stahl, nickel-matt / Textil, grau  
luminaire de table; acier, nickel mat / tissu, gris

H 400, Ø 180

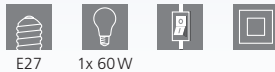

E27 1x 60W



9 002759 315962



### 95166 PASTERI

floor light; steel, satin nickel / fabric, grey  
Stehleuchte; Stahl, nickel-matt / Textil, grau  
lampadaire; acier, nickel mat / tissu, gris

H 1575, Ø 280, Base: Ø 230



E27 1x 60W



9 002759 951665







31578



96481

The main and reading lights can be switched on separately.

Das Haupt- und das Leselicht können getrennt voneinander geschaltet werden.

Les luminaires principales et de lecture peuvent être allumées séparément.



96481

LED

### 31578 PASTERI

pendant light; steel, satin nickel / fabric, anthracite-brown  
Hängeleuchte; Stahl, nickel-matt / Textil, anthrazit-braun  
luminaire en suspension; acier, nickel mat / tissu, marron anthracite

H 1100, Ø 530

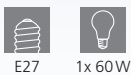

### 31574 PASTERI

pendant light; steel, satin nickel / fabric, anthracite-brown  
Hängeleuchte; Stahl, nickel-matt / Textil, anthrazit-braun  
luminaire en suspension; acier, nickel mat / tissu, marron anthracite

H 1100, Ø 380



### 96481 PASTERI

wall light; steel, satin nickel / fabric, anthracite-brown  
Wandleuchte; Stahl, nickel-matt / Textil, anthrazit-braun  
applique; acier, nickel mat / tissu, marron anthracite

L 150, H 380, A 195

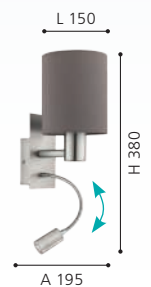



**31579**



**31575**



**31579 PASTERI**

pendant light; steel, satin nickel / fabric, white  
 Hängeleuchte; Stahl, nickel-matt / Textil, weiss  
 luminaire en suspension; acier, nickel mat / tissu, blanc

L 750, B 220, H 1100

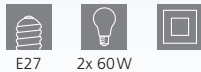

9 002759 315795



**31575 PASTERI**

pendant light; steel, satin nickel / fabric, white  
 Hängeleuchte; Stahl, nickel-matt / Textil, weiss  
 luminaire en suspension; acier, nickel mat / tissu, blanc

H 1100, Ø 530



9 002759 315757





**31571**



**94918**



**31588**

**LED**



94918

### 31571 PASTERI

pendant light; steel, satin nickel / fabric, white  
Hängeleuchte; Stahl, nickel-matt / Textil, weiss  
luminaire en suspension; acier, nickel mat / tissu, blanc

H 1100, Ø 380



9 002759 315719



### 31588 PASTERI

ceiling light; plastic, steel, white / fabric, white  
Deckenleuchte; Kunststoff, Stahl, weiss / Textil, weiss  
plafonnier; plastique, acier, blanc / tissu, blanc

H 90, Ø 320



9 002759 315887



### 94918 PASTERI

ceiling light; steel, satin nickel / fabric, glass, white  
Deckenleuchte; Stahl, nickel-matt / Textil, Glas, weiss  
plafonnier; acier, nickel mat / tissu, verre, blanc

H 195, Ø 475



9 002759 949181





94924



95118



96477

LED

95118

These luminaires can be switched on and off by touching the specially designed "Touch Me" part of the fixture.

Diese Leuchten können ein- und ausgeschaltet werden, indem man sie an den dafür vorgesehenen "Touch Me" Bereichen berührt.

Ces luminaires peuvent être éteints et allumés simplement en touchant la partie spécialement conçue pour "Touch Me" du luminaire.



### 96477 PASTERI

wall light; steel, satin nickel / fabric, white  
Wandleuchte; Stahl, nickel-matt / Textil, weiss  
applique; acier, nickel mat / tissu, blanc

L 150, H 380, A 195



E27



1x 40W



1x 3,8W



warm WHITE  
320lm



9 002759 964771

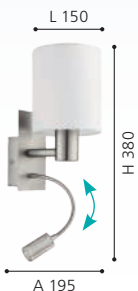

### 94924 PASTERI

wall light; steel, satin nickel / fabric, white  
Wandleuchte; Stahl, nickel-matt / Textil, weiss  
applique; acier, nickel mat / tissu, blanc

L 145, H 305, A 195



E27



1x 60W



9 002759 949242



### 95118 PASTERI

table light; steel, satin nickel / fabric, white  
Tischleuchte; Stahl, nickel-matt / Textil, weiss  
luminaire de table; acier, nickel mat / tissu, blanc

H 255, Ø 120



E27



1x 40W



9 002759 951184







**31594**



**95164**

### 31594 PASTERI

table light; steel, satin nickel / fabric, white  
Tischleuchte; Stahl, nickel-matt / Textil, weiss  
luminaire de table; acier, nickel mat / tissu, blanc

H 400, Ø 180



E27 1x 60W



9 002759 315948



### 95164 PASTERI

floor light; steel, satin nickel / fabric, white  
Stehleuchte; Stahl, nickel-matt / Textil, weiss  
lampadaire; acier, nickel mat / tissu, blanc

H 1575, Ø 280, Base: Ø 230



E27 1x 60W



9 002759 951641

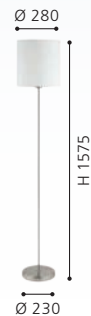



95044



95045



### 95044 PASTERI

pendant light; steel, satin nickel / fabric, white, copper  
 Hängeleuchte; Stahl, nickel-matt / Textil, weiss, kupfer  
 luminaire en suspension; acier, nickel mat / tissu, blanc, cuivre

H 1100, Ø 380



E27



1x 60W



9 002759 950446



### 95045 PASTERI

pendant light; steel, satin nickel / fabric, white, copper  
 Hängeleuchte; Stahl, nickel-matt / Textil, weiss, kupfer  
 luminaire en suspension; acier, nickel mat / tissu, blanc, cuivre

H 1100, Ø 530



E27



1x 60W



9 002759 950453





96483



96484



### 96483 PASTERI

wall light; steel, satin nickel / fabric, black, copper  
Wandleuchte; Stahl, nickel-matt / Textil, schwarz, kupfer  
applique; acier, nickel mat / tissu, noir, cuivre

L 150, H 380, A 195



E27



1x 40W



1x 3,8W



320lm



9 002759 964832

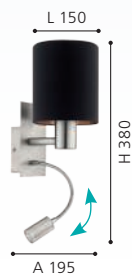

### 96484 PASTERI

wall light; steel, satin nickel / fabric, white, copper  
Wandleuchte; Stahl, nickel-matt / Textil, weiss, kupfer  
applique; acier, nickel mat / tissu, blanc, cuivre

L 150, H 380, A 195



E27



1x 40W



1x 3,8W



320lm



9 002759 964849



96483, 96484

The main and reading lights can be switched on separately.

Das Haupt- und das Leselicht können getrennt voneinander geschaltet werden.

Les luminaires principales et de lecture peuvent être allumées séparément.



**97643**



**97644**

**97643 VISERBELLA**

pendant light; steel, champagne / fabric, gold  
 Hängeleuchte; Stahl, champagner / Textil, gold  
 luminaire en suspension; acier, champagne / tissu, doré

H 1100, Ø 380

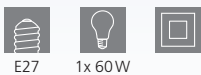

9 002759 976439



**97644 VISERBELLA**

pendant light; steel, champagne / fabric, gold  
 Hängeleuchte; Stahl, champagner / Textil, gold  
 luminaire en suspension; acier, champagne / tissu, doré

H 1100, Ø 530



9 002759 976446



**97641 VISERBELLA**

ceiling light; steel, champagne / fabric, gold  
 Deckenleuchte; Stahl, champagner / Textil, gold  
 plafonnier; acier, champagne / tissu, doré

H 110, Ø 380



9 002759 976415







97641



97642



97641 | 97642



### 97642 VISERBELLA

ceiling light; steel, champagne / fabric, gold  
Deckenleuchte; Stahl, champagner / Textil, gold  
plafonnier; acier, champagne / tissu, doré

H 195, Ø 470

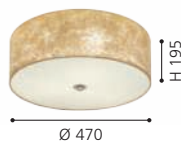





DESIGN  
HIGHLIGHT  
DETAIL



97645



97647

### 97645 VISERBELLA

wall light; steel, champagne / fabric, gold  
Wandleuchte; Stahl, champagner / Textil, gold  
applique; acier, champagne / tissu, doré

L 145, H 305, A 195



E27 1x 60W



9 002759 976453



### 97647 VISERBELLA

floor light; steel, champagne / fabric, gold  
Stehleuchte; Stahl, champagner / Textil, gold  
lampadaire; acier, champagne / tissu, doré

H 1585, Ø 280, Base: Ø 230

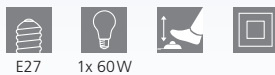

E27 1x 60W



9 002759 976477



### 97646 VISERBELLA

table light; steel, champagne / fabric, gold  
Tischleuchte; Stahl, champagner / Textil, gold  
luminaire de table; acier, champagne / tissu, doré

H 400, Ø 180, Base: Ø 150

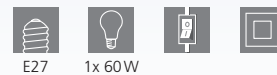

E27 1x 60W



9 002759 976460

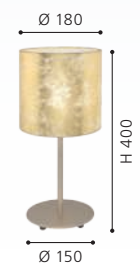



97646



DESIGN  
HIGHLIGHT  
DETAIL



### 99273 ESTEPERRA

pendant light; steel, black / fabric, black, gold  
Hängeleuchte; Stahl, schwarz / Textil, schwarz, gold  
luminaire en suspension; acier, noir / tissu, noir, or

H 1100, Ø 380



### 99272 ESTEPERRA

ceiling light; steel, black / fabric, black, gold  
Deckenleuchte; Stahl, schwarz / Textil, schwarz, gold  
plafonnier; acier, noir / tissu, noir, or

H 240, Ø 475

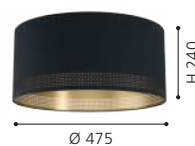

### 99274 ESTEPERRA

pendant light; steel, black / fabric, black, gold  
Hängeleuchte; Stahl, schwarz / Textil, schwarz, gold  
luminaire en suspension; acier, noir / tissu, noir, or

H 1100, Ø 530

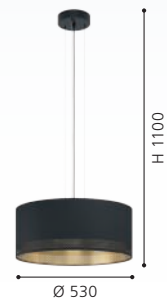





99274



99279



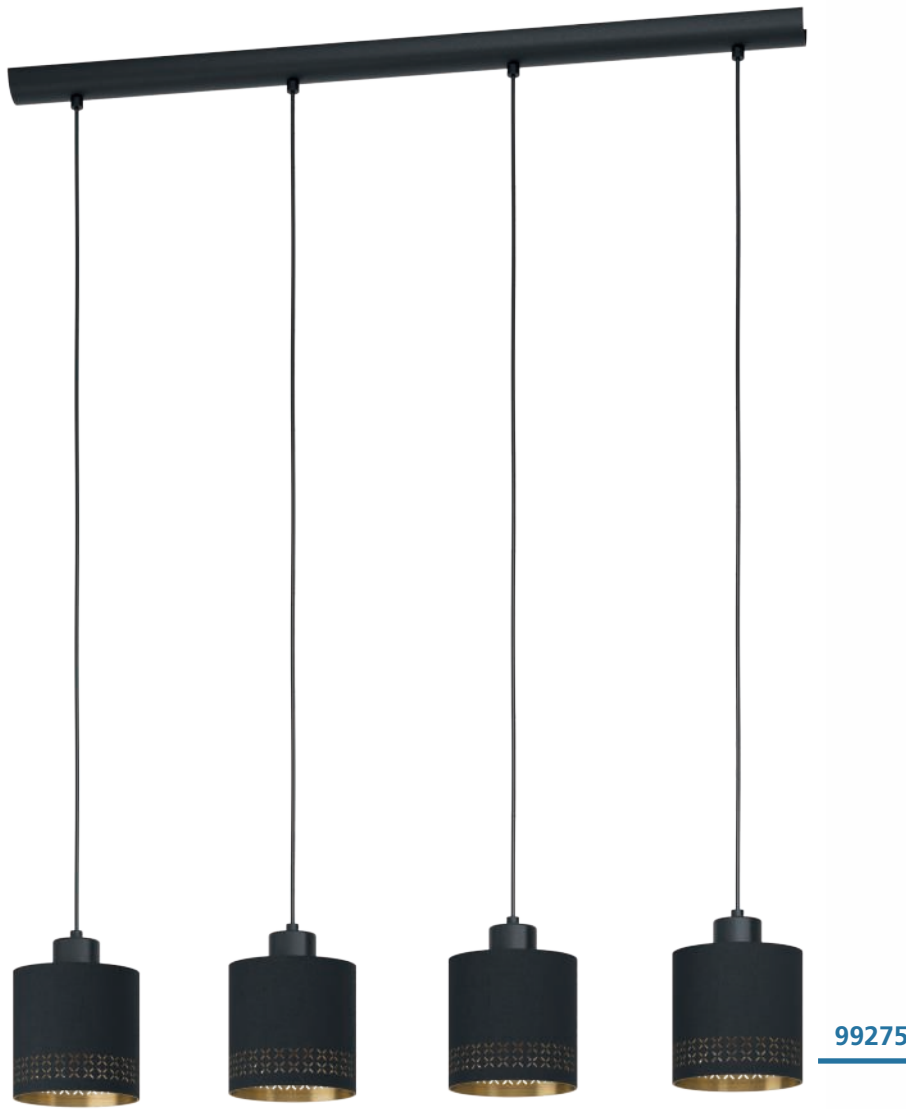

DESIGN  
HIGHLIGHT  
DETAIL



### 99279 ESTEPERRA

floor light; steel, black / fabric, black, gold  
Stehleuchte; Stahl, schwarz / Textil, schwarz, gold  
lampadaire; acier, noir / tissu, noir, or

H 1405, Ø 380, Base: Ø 645



E27 1x 40W



9 002759 992798

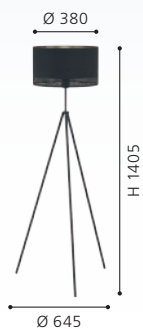

### 99275 ESTEPERRA

pendant light; steel, black / fabric, black, gold  
Hängeleuchte; Stahl, schwarz / Textil, schwarz, gold  
luminaire en suspension; acier, noir / tissu, noir, or

L 940, B 160, H 1100



E27 4x 28W



9 002759 992750





98313

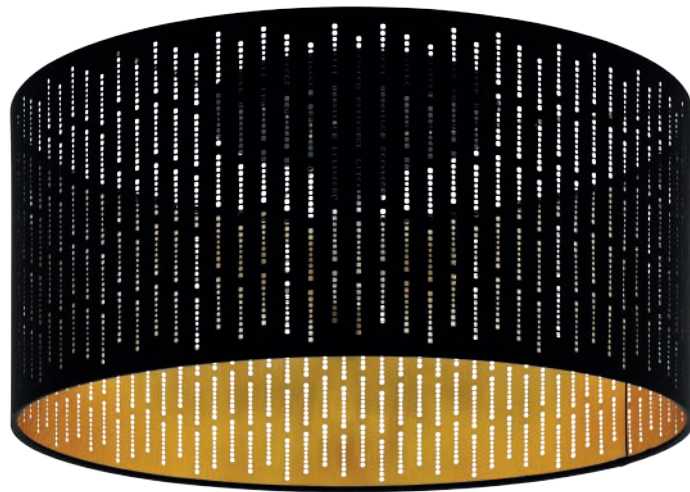

98311



98314

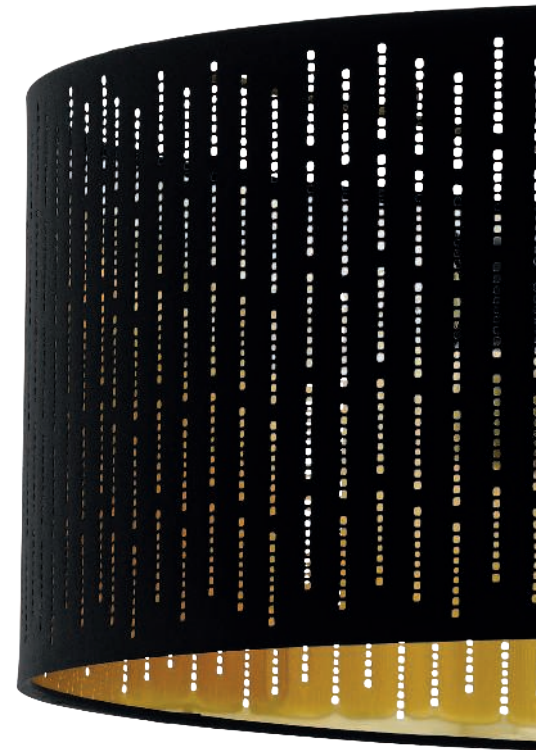

### 98313 VARILLAS

pendant light; steel, black / fabric with cut-outs, black, gold  
 Hängeleuchte; Stahl, schwarz / Textil mit Ausstanzungen, schwarz, gold  
 luminaire en suspension; acier, noir / tissu avec découpes, noir, or

H 1100, Ø 530



E27 3x 40W



9 002759 983130



### 98311 VARILLAS

ceiling light; steel, black / fabric with cut-outs, black, gold  
 Deckenleuchte; Stahl, schwarz / Textil mit Ausstanzungen, schwarz, gold  
 plafonnier; acier, noir / tissu avec découpes, noir, or

H 240, Ø 475



E27 1x 40W



9 002759 983116

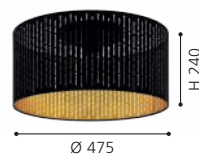

### 98314 VARILLAS

table light; steel, black / fabric with cut-outs, black, gold  
 Tischleuchte; Stahl, schwarz / Textil mit Ausstanzungen, schwarz, gold  
 luminaire de table; acier, noir / tissu avec découpes, noir, or

H 255, Ø 120

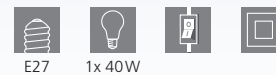

E27 1x 40W



9 002759 983147

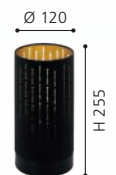





99613

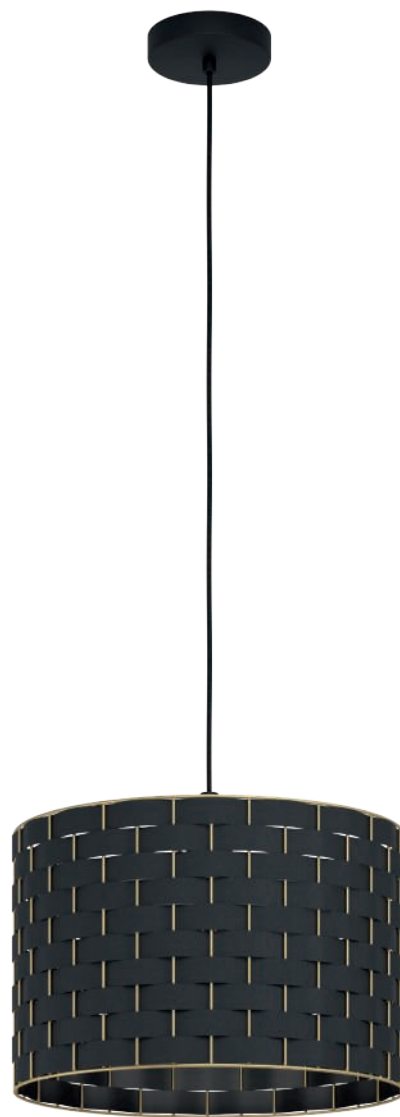

99524

### 99613 MARASALES

pendant light; steel, black / fabric, black, brass  
 Hängeleuchte; Stahl, schwarz / Textil, schwarz, messing  
 luminaire en suspension; acier, noir / tissu, noir, laiton

L 780, B 220, H 1100

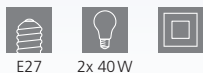

E27 2x 40W



9 002759 996130

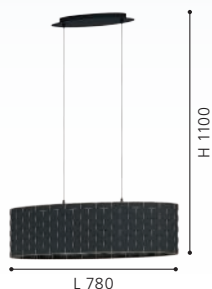

### 99524 MARASALES

pendant light; steel, black / fabric, black, brass  
 Hängeleuchte; Stahl, schwarz / Textil, schwarz, messing  
 luminaire en suspension; acier, noir / tissu, noir, laiton

H 1100, Ø 380



E27 1x 40W



9 002759 995249



### 99525 MARASALES

pendant light; steel, black / fabric, black, brass  
 Hängeleuchte; Stahl, schwarz / Textil, schwarz, messing  
 luminaire en suspension; acier, noir / tissu, noir, laiton

H 1100, Ø 550



E27 1x 40W



9 002759 995256



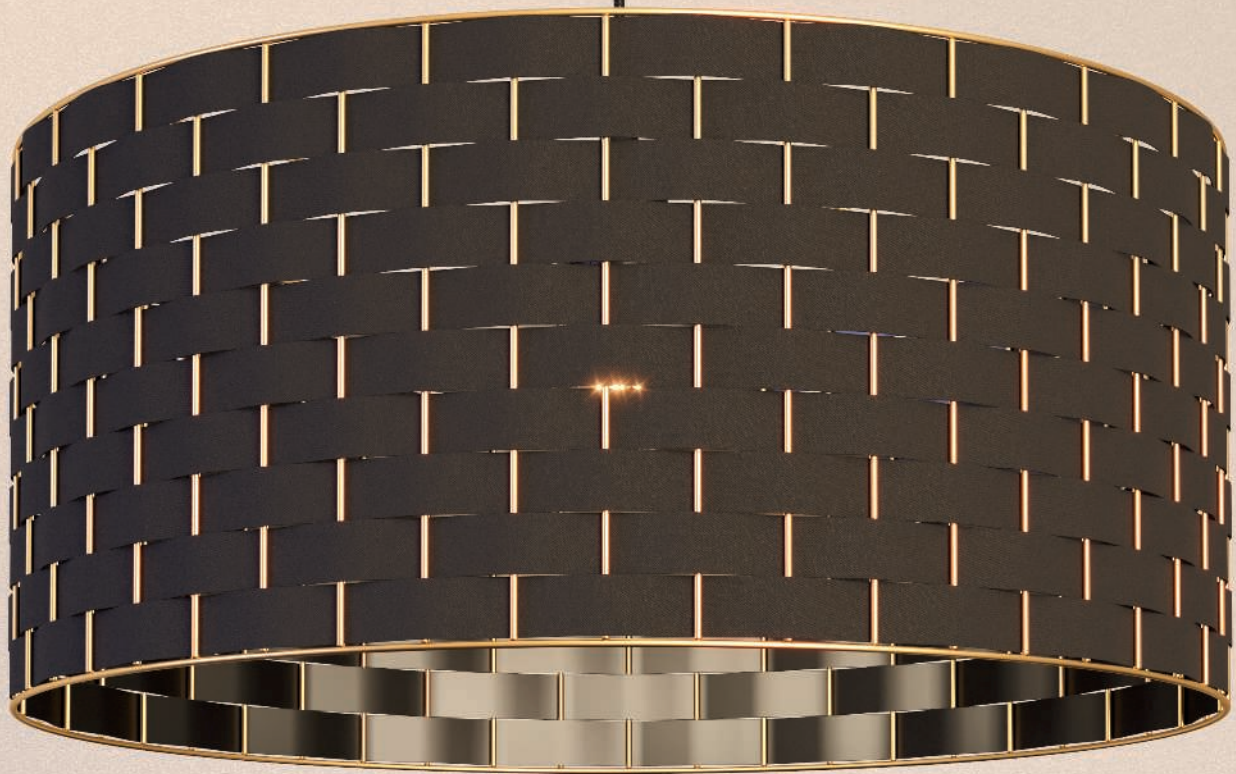

99525







99523

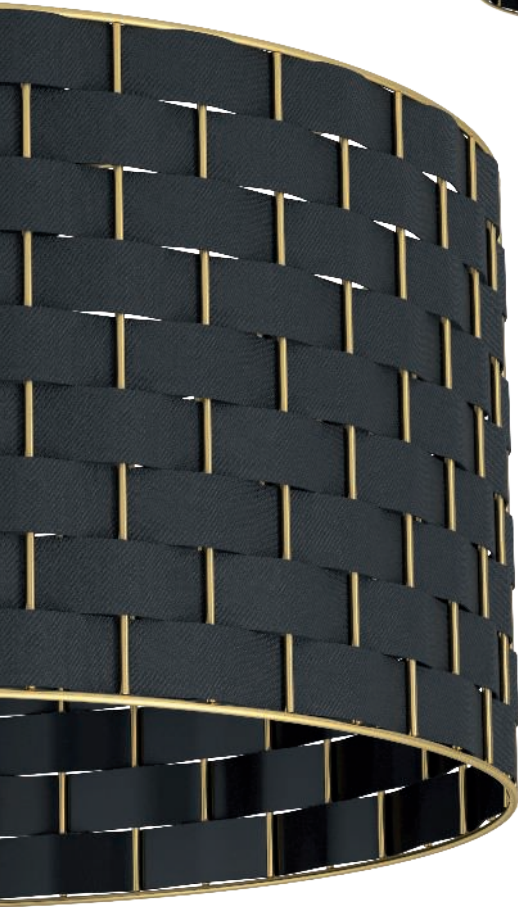

99526

### 99523 MARASALES

ceiling light; steel, black / fabric, black, brass  
Deckenleuchte; Stahl, schwarz / Textil, schwarz, messing  
plafonnier; acier, noir / tissu, noir, laiton

H 250, Ø 480



E27

1x 40W

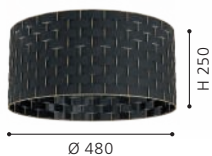

### 99526 MARASALES

table light; steel, black / fabric, black, brass  
Tischleuchte; Stahl, schwarz / Textil, schwarz, messing  
luminaire de table; acier, noir / tissu, noir, laiton

H 570, Ø 280



E27

1x 40W



### 99527 MARASALES

floor light; steel, black / fabric, black, brass  
Stehleuchte; Stahl, schwarz / Textil, schwarz, messing  
lampadaire; acier, noir / tissu, noir, laiton

H 1490, Ø 450, Base: Ø 745



E27

1x 40W

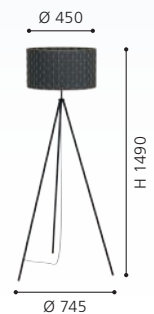





99527





900145



900144

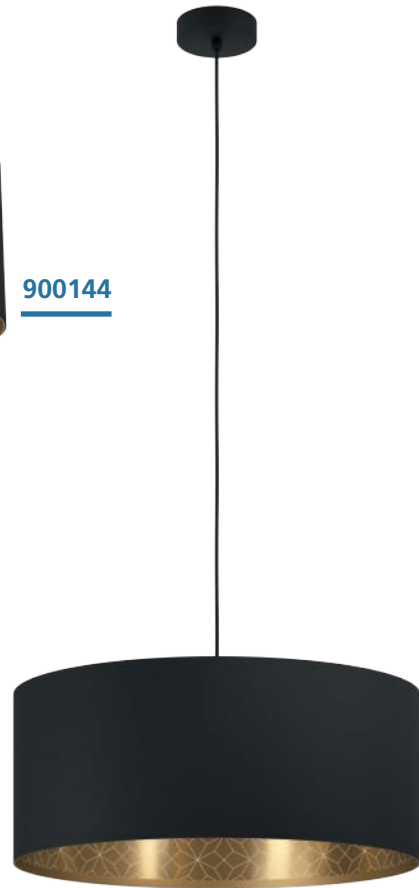

900146

### 900145 ZARAGOZA

pendant light; steel, black / fabric with decor, black, gold  
 Hängeleuchte; Stahl, schwarz / Textil mit Dekor, schwarz, gold  
 luminaire en suspension; acier, noir / tissu avec décor, noir, or

H 1100, Ø 380



9 008606 235384



### 900144 ZARAGOZA

ceiling light; steel, black / fabric with decor, black, gold  
 Deckenleuchte; Stahl, schwarz / Textil mit Dekor, schwarz, gold  
 plafonnier; acier, noir / tissu avec décor, noir, or

H 240, Ø 475



9 008606 235377

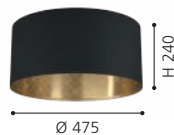

### 900146 ZARAGOZA

pendant light; steel, black / fabric with decor, black, gold  
 Hängeleuchte; Stahl, schwarz / Textil mit Dekor, schwarz, gold  
 luminaire en suspension; acier, noir / tissu avec décor, noir, or

H 1100, Ø 530



9 008606 235391

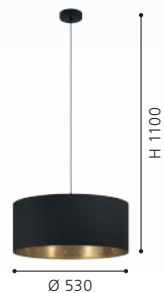

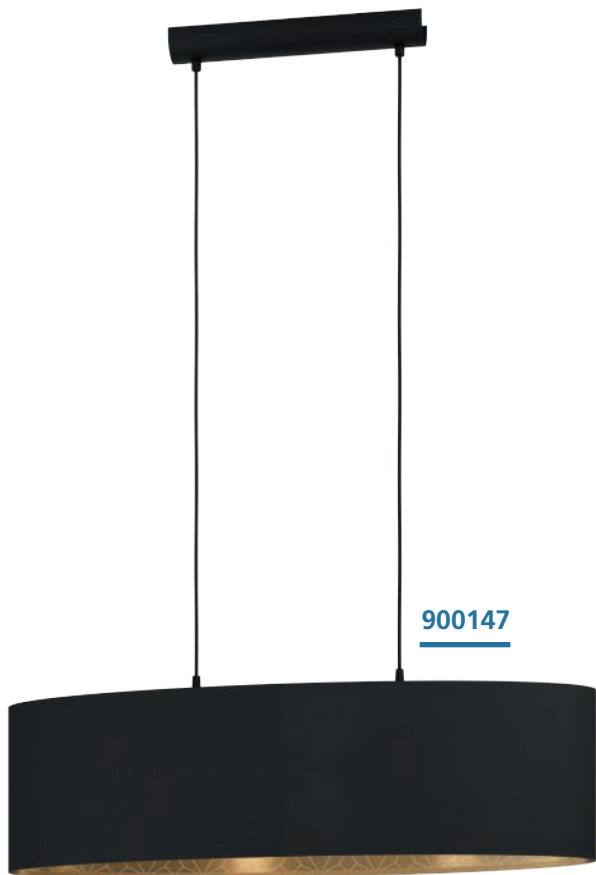

**900147**

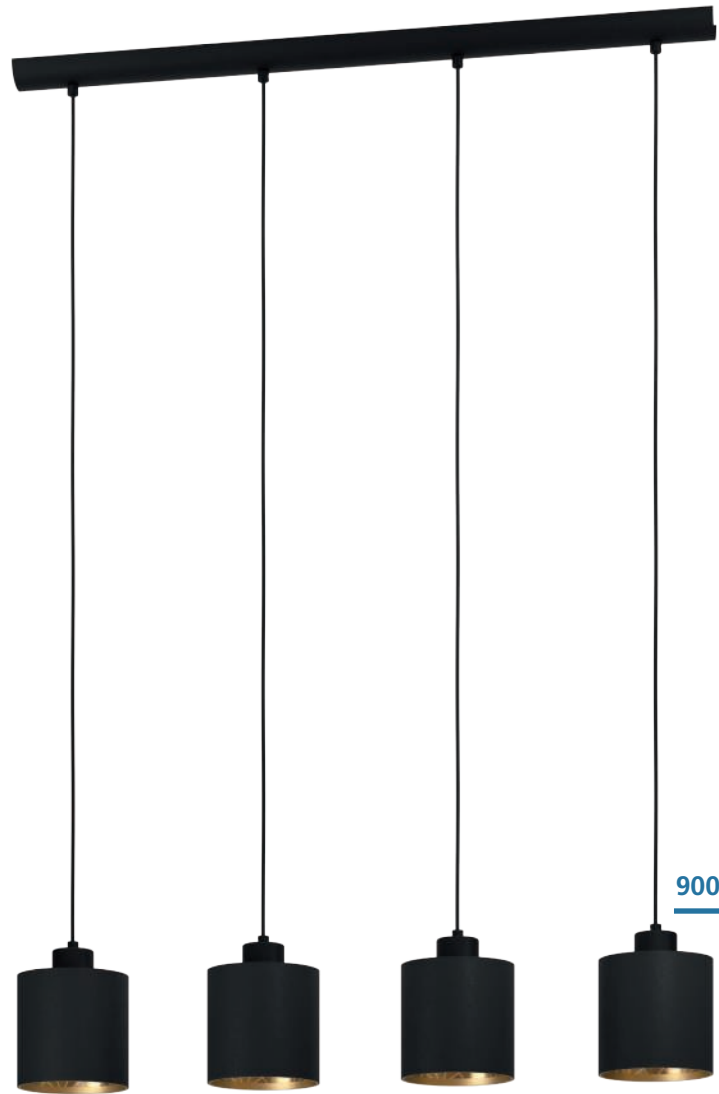

**900148**

**900147 ZARAGOZA**

pendant light; steel, black / fabric with decor, black, gold  
 Hängeleuchte; Stahl, schwarz / Textil mit Dekor, schwarz, gold  
 luminaire en suspension; acier, noir / tissu avec décor, noir, or

L 780, B 220, H 1100

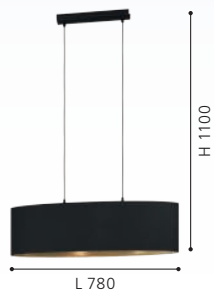

**900148 ZARAGOZA**

pendant light; steel, black / fabric with decor, black, gold  
 Hängeleuchte; Stahl, schwarz / Textil mit Dekor, schwarz, gold  
 luminaire en suspension; acier, noir / tissu avec décor, noir, or

L 925, B 160, H 1100

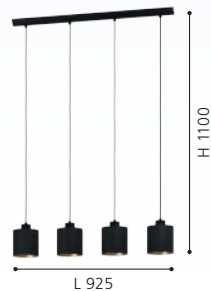



**900634**

**900634 BUCAMARANGA**

ceiling light; steel, white / fabric with decor, white, gold  
 Deckenleuchte; Stahl, weiss / Textil mit Dekor, weiss, gold  
 plafonnier; acier, blanc / tissu avec décor, blanc, or

H 240, Ø 475



**900635 BUCAMARANGA**

pendant light; steel, white / fabric with decor, white, gold  
 Hängeleuchte; Stahl, weiss / Textil mit Dekor, weiss, gold  
 luminaire en suspension; acier, blanc / tissu avec décor, blanc, or

H 1100, Ø 530







900635





**31601**



**99543**

**LED**

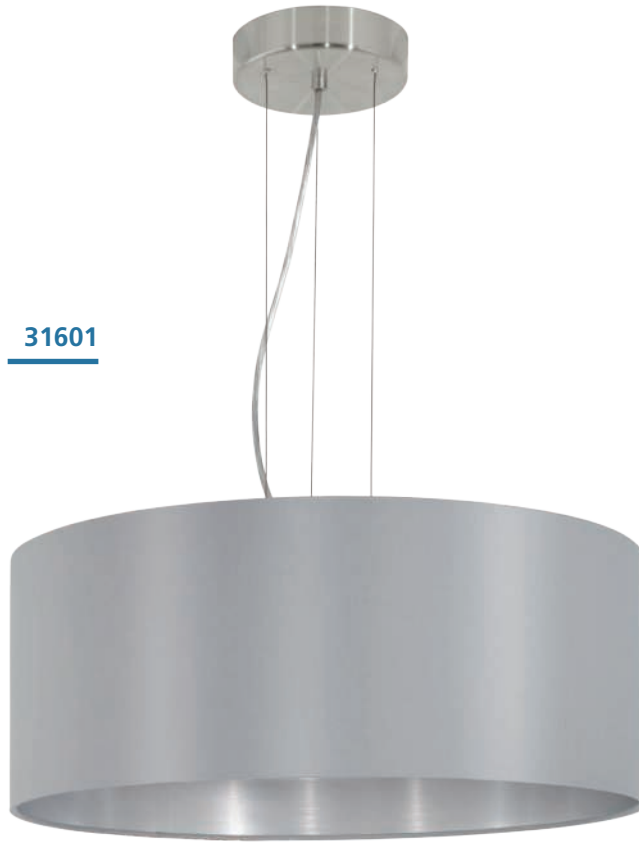

**31606**

### 31601 MASERLO

pendant light; steel, satin nickel / fabric, grey, silver  
 Hängeleuchte; Stahl, nickel-matt / Textil, grau, silber  
 luminaire en suspension; acier, nickel mat / tissu, gris, argent

H 1100, Ø 380

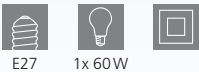

9 002759 316013

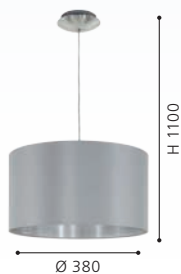

### 31606 MASERLO

pendant light; steel, satin nickel / fabric, grey, silver  
 Hängeleuchte; Stahl, nickel-matt / Textil, grau, silber  
 luminaire en suspension; acier, nickel mat / tissu, gris, argent

H 1100, Ø 530



9 002759 316068



### 99543 MASERLO 2

ceiling light; plastic, steel, white / fabric, grey, silver  
 Deckenleuchte; Kunststoff, Stahl, weiss / Textil, grau, silber  
 plafonnier; plastique, acier, blanc / tissu, gris, argent

H 90, Ø 380



9 002759 995430

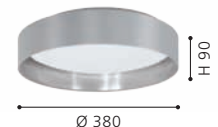



**31628**

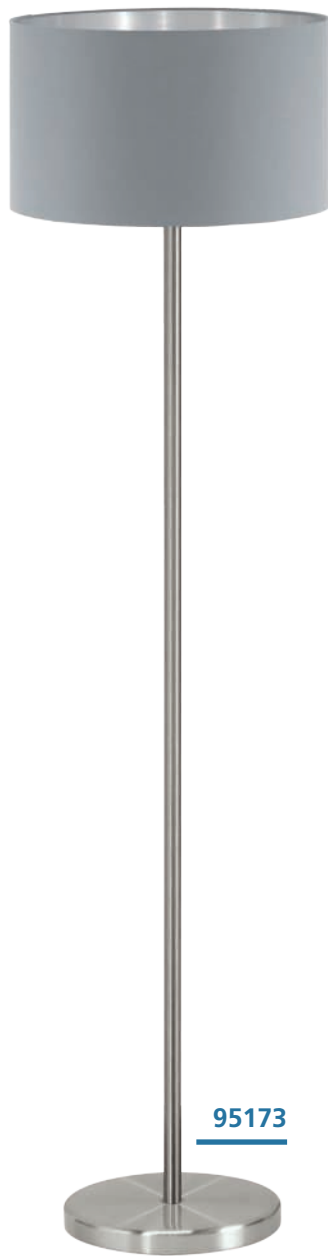

**95173**



### 31628 MASERLO

table light; steel, satin nickel / fabric, grey, silver  
 Tischleuchte; Stahl, nickel-matt / Textil, grau, silber  
 luminaire de table; acier, nickel mat / tissu, gris, argent

H 420, Ø 230

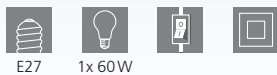

E27 1x 60W



### 95173 MASERLO

floor light; steel, satin nickel / fabric, grey, silver  
 Stehleuchte; Stahl, nickel-matt / Textil, grau, silber  
 lampadaire; acier, nickel mat / tissu, gris, argent

H 1510, Ø 380, Base: Ø 250



E27 1x 60W

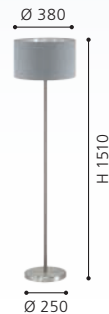





99044





99042



99043



MASERLO 1

### 99044 MASERLO 1

pendant light; steel, black / fabric, black  
 Hängeleuchte; Stahl, schwarz / Textil, schwarz  
 luminaire en suspension; acier, noir / tissu, noir

L 780, B 220, H 1100

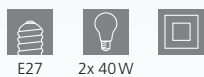

E27 2x 40W



9 002759 990442

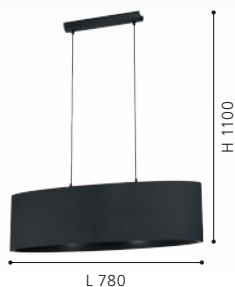

### 99042 MASERLO 1

pendant light; steel, black / fabric, black  
 Hängeleuchte; Stahl, schwarz / Textil, schwarz  
 luminaire en suspension; acier, noir / tissu, noir

H 1100, Ø 380

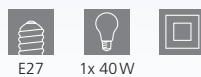

E27 1x 40W



9 002759 990428



### 99043 MASERLO 1

pendant light; steel, black / fabric, black  
 Hängeleuchte; Stahl, schwarz / Textil, schwarz  
 luminaire en suspension; acier, noir / tissu, noir

H 1100, Ø 530

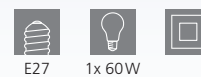

E27 1x 60W



9 002759 990435





DESIGN  
HIGHLIGHT  
DETAIL



99041



MASERLO 1



99045

### 99041 MASERLO 1

ceiling light; steel, black / fabric, black  
Deckenleuchte; Stahl, schwarz / Textil, schwarz  
plafonnier; acier, noir / tissu, noir

H 240, Ø 400



E27 1x 40W



9 002759 990411

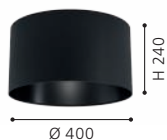

### 99045 MASERLO 1

table light; steel, black / fabric, black  
Tischleuchte; Stahl, schwarz / Textil, schwarz  
luminaire de table; acier, noir / tissu, noir

H 415, Ø 230, Base: Ø 145



E27 1x 40W



9 002759 990459



### 99046 MASERLO 1

floor light; steel, black / fabric, black  
Stehleuchte; Stahl, schwarz / Textil, schwarz  
lampadaire; acier, noir / tissu, noir

H 1515, Ø 380, Base: Ø 250



E27 1x 40W



9 002759 990466





99046



31611

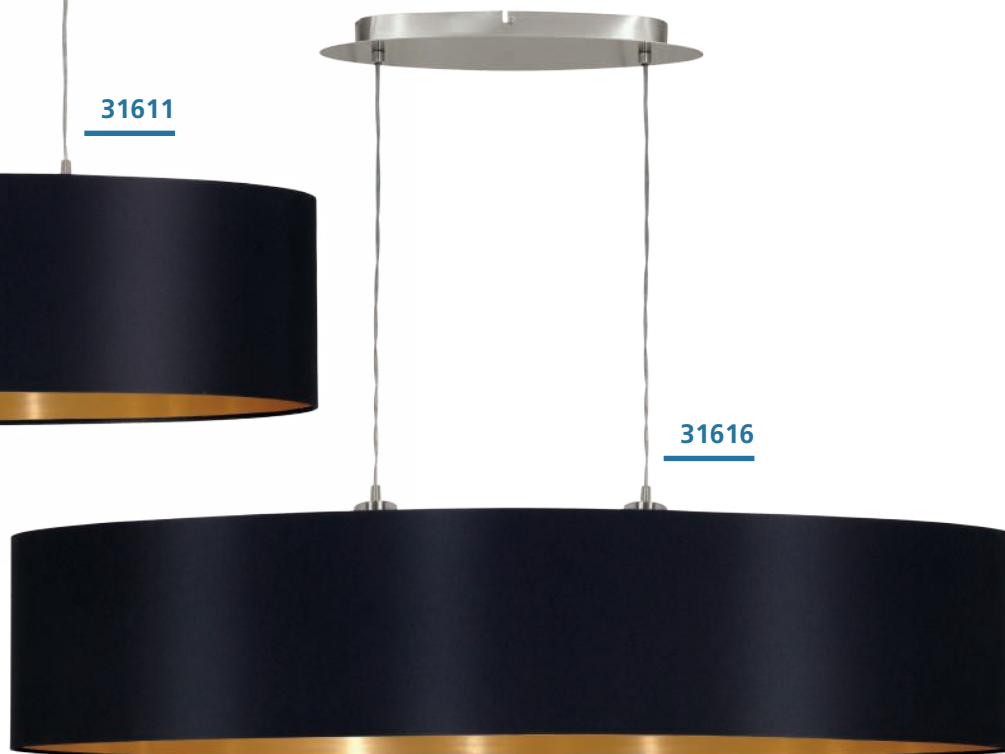

31616



### 31611 MASERLO

pendant light; steel, satin nickel / fabric, black, gold  
 Hängeleuchte; Stahl, nickel-matt / Textil, schwarz, gold  
 luminaire en suspension; acier, nickel mat / tissu, noir, or

L 780, B 220, H 1100

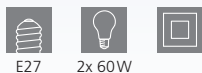

9 002759 316112

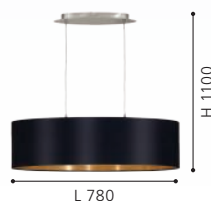

### 31616 MASERLO

pendant light; steel, satin nickel / fabric, black, gold  
 Hängeleuchte; Stahl, nickel-matt / Textil, schwarz, gold  
 luminaire en suspension; acier, nickel mat / tissu, noir, or

L 1000, B 250, H 1100

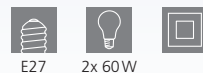

9 002759 316167

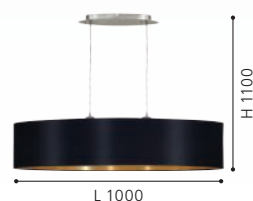





### 31599 MASERLO

pendant light; steel, satin nickel / fabric, black, gold  
 Hängeleuchte; Stahl, nickel-matt / Textil, schwarz, gold  
 luminaire en suspension; acier, nickel mat / tissu, noir, or

H 1100, Ø 380

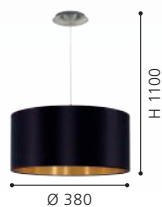
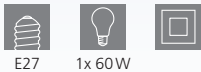

### 31605 MASERLO

pendant light; steel, satin nickel / fabric, black, gold  
 Hängeleuchte; Stahl, nickel-matt / Textil, schwarz, gold  
 luminaire en suspension; acier, nickel mat / tissu, noir, or

H 1100, Ø 530

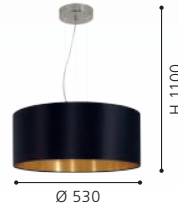



99539

LED



31627

### 99539 MASERLO 2

ceiling light; plastic, steel, white / fabric, black, gold  
Deckenleuchte; Kunststoff, Stahl, weiss / Textil, schwarz, gold  
plafonnier; plastique, acier, blanc / tissu, noir, or

H 90, Ø 380



21,6W 2500lm



9 002759 995393

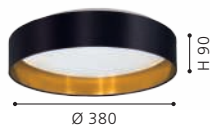

### 31627 MASERLO

table light; steel, satin nickel / fabric, black, gold  
Tischleuchte; Stahl, nickel-matt / Textil, schwarz, gold  
luminaire de table; acier, nickel mat / tissu, noir, or

H 420, Ø 230



E27 1x 60W



9 002759 316273



### 95169 MASERLO

floor light; steel, satin nickel / fabric, black, gold  
Stehleuchte; Stahl, nickel-matt / Textil, schwarz, gold  
lampadaire; acier, nickel mat / tissu, noir, or

H 1510, Ø 380, Base: Ø 250



E27 1x 60W



9 002759 951696

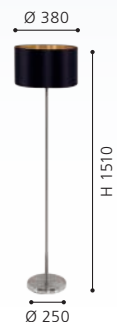



95169



**31618**

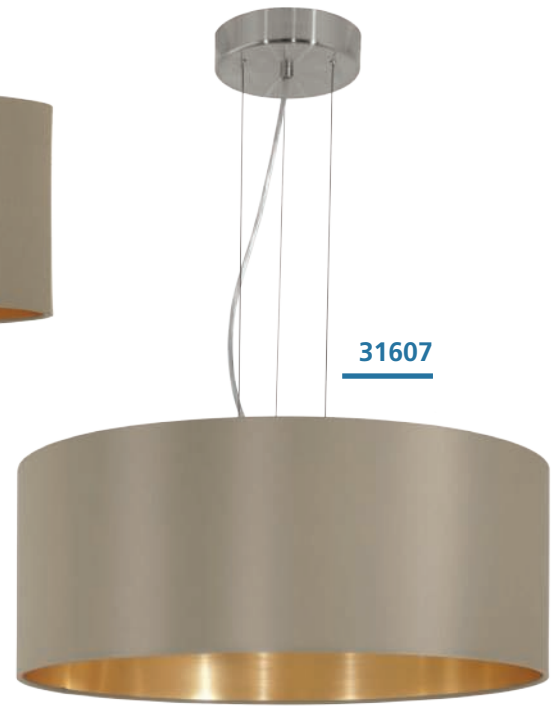

**31607**



**31618 MASERLO**

pendant light; steel, satin nickel / fabric, taupe, gold  
 Hängeleuchte; Stahl, nickel-matt / Textil, taupe, gold  
 luminaire en suspension; acier, nickel mat / tissu, taupe, or

L 1000, B 250, H 1100

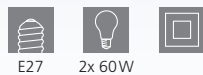

E27 2x 60W

**31607 MASERLO**

pendant light; steel, satin nickel / fabric, taupe, gold  
 Hängeleuchte; Stahl, nickel-matt / Textil, taupe, gold  
 luminaire en suspension; acier, nickel mat / tissu, taupe, or

H 1100, Ø 530



E27 3x 60W

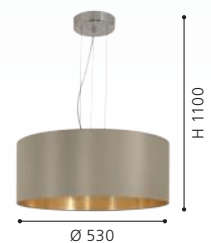
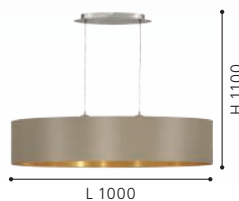
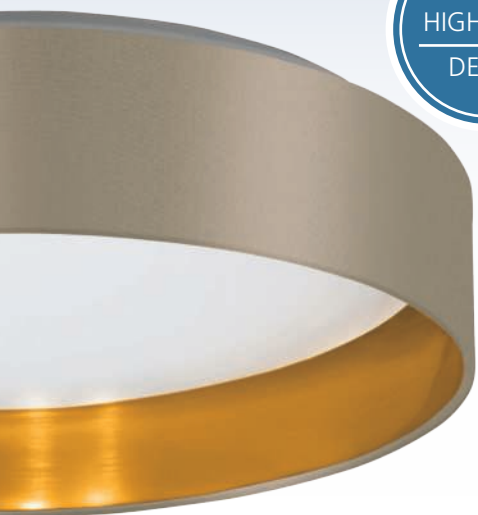





99541



31602



31613

### 31602 MASERLO

pendant light; steel, satin nickel / fabric, taupe, gold  
 Hängeleuchte; Stahl, nickel-matt / Textil, taupe, gold  
 luminaire en suspension; acier, nickel mat / tissu, taupe, or

H 1100, Ø 380



E27 1x 60W



### 99541 MASERLO 2

ceiling light; plastic, steel, white / fabric, taupe, gold  
 Deckenleuchte; Kunststoff, Stahl, weiss / Textil, taupe, gold  
 plafonnier; plastique, acier, blanc / tissu, taupe, or

H 90, Ø 380



LED 21,6W 2500lm

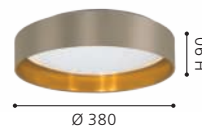

### 31613 MASERLO

pendant light; steel, satin nickel / fabric, taupe, gold  
 Hängeleuchte; Stahl, nickel-matt / Textil, taupe, gold  
 luminaire en suspension; acier, nickel mat / tissu, taupe, or

L 780, B 220, H 1100

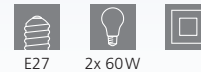

E27 2x 60W

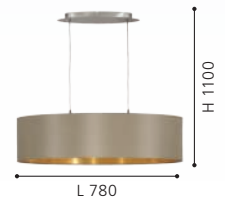

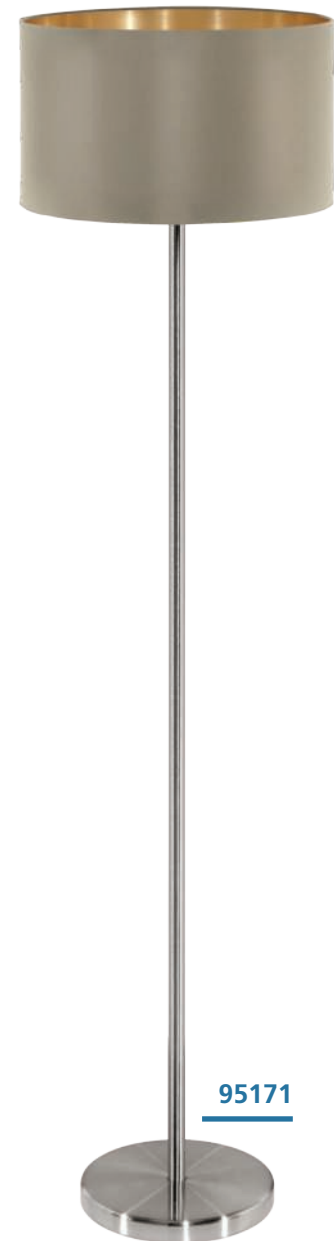

### 95055 MASERLO

wall light; steel, satin nickel / fabric, taupe, gold  
Wandleuchte; Stahl, nickel-matt / Textil, taupe, gold  
applique; acier, nickel mat / tissu, taupe, or

H 260, Ø 230, A 595

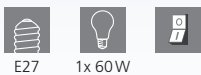

### 31629 MASERLO

table light; steel, satin nickel / fabric, taupe, gold  
Tischleuchte; Stahl, nickel-matt / Textil, taupe, gold  
luminaire de table; acier, nickel mat / tissu, taupe, or

H 420, Ø 230

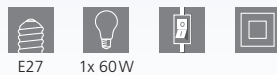

### 95171 MASERLO

floor light; steel, satin nickel / fabric, taupe, gold  
Stehleuchte; Stahl, nickel-matt / Textil, taupe, gold  
lampadaire; acier, nickel mat / tissu, taupe, or

H 1510, Ø 380, Base: Ø 250





### 31614 MASERLO

pendant light; steel, satin nickel / fabric, cappuccino, gold  
 Hängeleuchte; Stahl, nickel-matt / Textil, cappuccino, gold  
 luminaire en suspension; acier, nickel mat / tissu, cappucino, or

L 780, B 220, H 1100

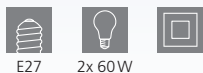

E27 2x 60W



9 002759 316143

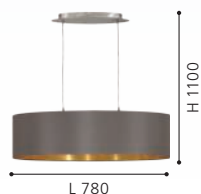

### 31619 MASERLO

pendant light; steel, satin nickel / fabric, cappuccino, gold  
 Hängeleuchte; Stahl, nickel-matt / Textil, cappuccino, gold  
 luminaire en suspension; acier, nickel mat / tissu, cappucino, or

L 1000, B 250, H 1100

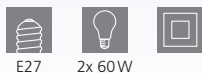

E27 2x 60W



9 002759 316198



### 31603 MASERLO

pendant light; steel, satin nickel / fabric, cappuccino, gold  
 Hängeleuchte; Stahl, nickel-matt / Textil, cappuccino, gold  
 luminaire en suspension; acier, nickel mat / tissu, cappucino, or

H 1100, Ø 380

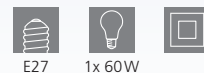

E27 1x 60W



9 002759 316037





99542

LED

DESIGN  
HIGHLIGHT  
DETAIL

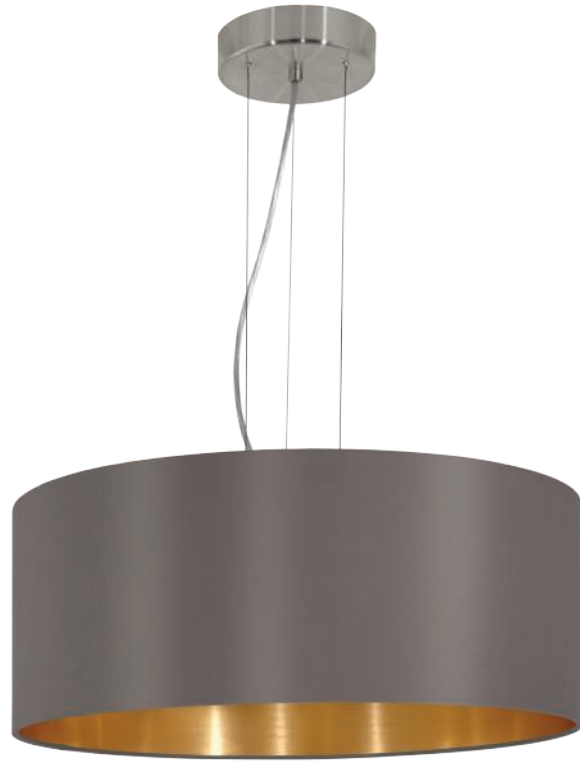

31608

### 99542 MASERLO 2

ceiling light; plastic, steel, white / fabric, cappuccino, gold  
Deckenleuchte; Kunststoff, Stahl, weiss / Textil, cappuccino, gold  
plafonnier; plastique, acier, blanc / tissu, cappuccino, or

H 90, Ø 380

LED

warm  
WHITE



21,6W 2500lm



9 002759 995423

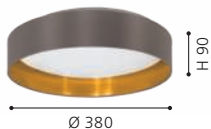

### 31608 MASERLO

pendant light; steel, satin nickel / fabric, cappuccino, gold  
Hängeleuchte; Stahl, nickel-matt / Textil, cappuccino, gold  
luminaire en suspension; acier, nickel mat / tissu, cappuccino, or

H 1100, Ø 530



E27



3x 60W



9 002759 316082



### 31631 MASERLO

table light; steel, satin nickel / fabric, cappuccino, gold  
Tischleuchte; Stahl, nickel-matt / Textil, cappuccino, gold  
luminaire de table; acier, nickel mat / tissu, cappuccino, or

H 420, Ø 230



E27



1x 60W



9 002759 316310







**31631**

**95172 MASERLO**

floor light; steel, satin nickel / fabric, cappuccino, gold  
 Stehleuchte; Stahl, nickel-matt / Textil, cappuccino, gold  
 lampadaire; acier, nickel mat / tissu, cappucino, or

H 1510, Ø 380, Base: Ø 250



E27



1x 60W



9 002759 951726

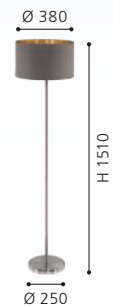

**95172**



97684

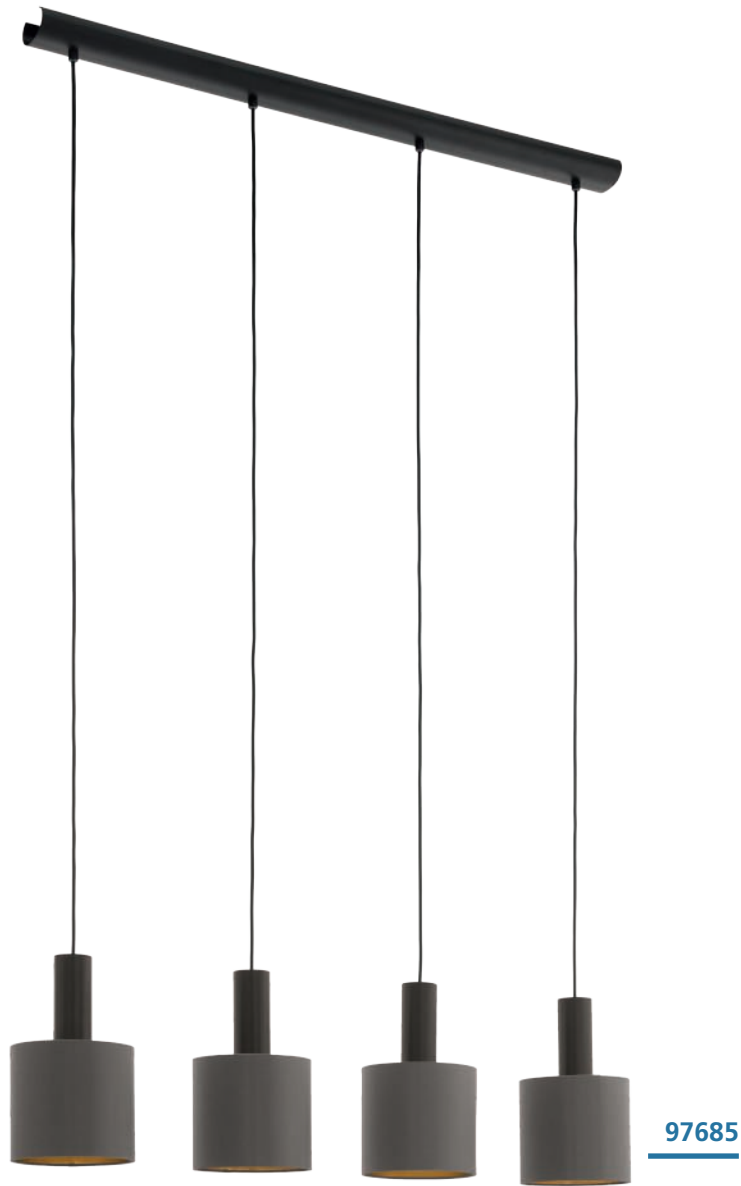

97685

### 97684 CONCESSA 1

pendant light; steel, dark brown / fabric, cappuccino, gold  
 Hängeleuchte; Stahl, dunkelbraun / Textil, cappuccino, gold  
 luminaire en suspension; acier, marron foncé / tissu, cappuccino, or

H 1500, Ø 420



### 97685 CONCESSA 1

pendant light; steel, dark brown / fabric, cappuccino, gold  
 Hängeleuchte; Stahl, dunkelbraun / Textil, cappuccino, gold  
 luminaire en suspension; acier, marron foncé / tissu, cappuccino, or

L 940, B 160, H 1500

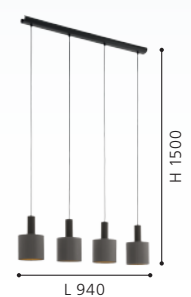

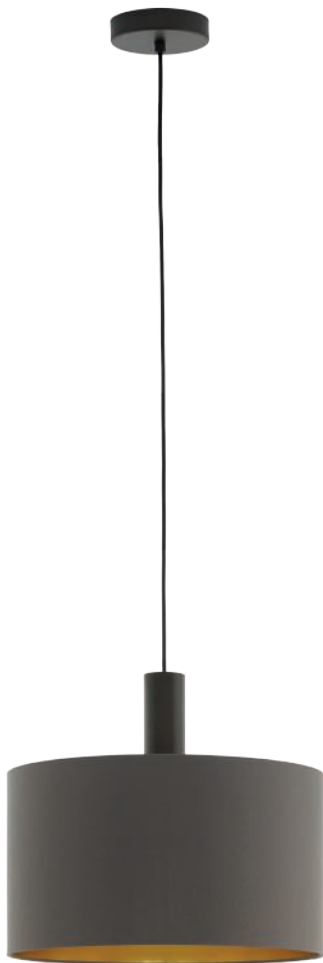

**97682**



**97683**

DESIGN  
HIGHLIGHT  
DETAIL

### 97682 CONCESSA 1

pendant light; steel, dark brown / fabric, cappuccino, gold  
Hängeleuchte; Stahl, dunkelbraun / Textil, cappuccino, gold  
luminaire en suspension; acier, marron foncé / tissu, cappuccino, or

H 1500, Ø 380

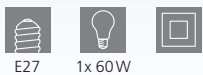

E27 1x 60W



9 002759 976828



### 97683 CONCESSA 1

pendant light; steel, dark brown / fabric, cappuccino, gold  
Hängeleuchte; Stahl, dunkelbraun / Textil, cappuccino, gold  
luminaire en suspension; acier, marron foncé / tissu, cappuccino, or

H 1500, Ø 530

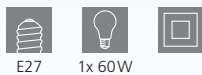

E27 1x 60W



9 002759 976835



DESIGN  
HIGHLIGHT  
DETAIL



99445



99446



### 99445 ALBARIZA

pendant light; steel, wood, black, brown / fabric, cappuccino, gold

Hängeleuchte; Stahl, Holz, schwarz, braun / Textil, cappuccino, gold

luminaire en suspension; acier, bois, noir, marron / tissu, cappuccino, or

H 1100, Ø 160



E27

1x 40W



9 002759 994457



### 99446 ALBARIZA

pendant light; steel, wood, black, brown / fabric, cappuccino, gold

Hängeleuchte; Stahl, Holz, schwarz, braun / Textil, cappuccino, gold

luminaire en suspension; acier, bois, noir, marron / tissu, cappuccino, or

L 895, B 160, H 1100



E27

3x 40W



9 002759 994464



### 99447 ALBARIZA

pendant light; steel, wood, black, brown / fabric, cappuccino, gold

Hängeleuchte; Stahl, Holz, schwarz, braun / Textil, cappuccino, gold

luminaire en suspension; acier, bois, noir, marron / tissu, cappuccino, or

H 1500, Ø 700



E27

5x 40W



9 002759 994471







99447





### 99487 ALMEIDA 2

pendant light; steel, brushed brass / fabric, cappuccino, brass  
 Hängeleuchte; Stahl, messing-gebürstet / Textil, cappuccino, messing  
 luminaire en suspension; acier, laiton brossé / tissu, cappuccino, laiton

L 1200, B 155, H 1100



E14 5x 40W



9 002759 994877

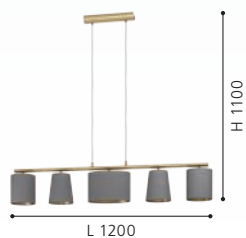

### 99486 ALMEIDA 2

ceiling light; steel, brushed brass / fabric, cappuccino, brass  
 Deckenleuchte; Stahl, messing-gebürstet / Textil, cappuccino, messing  
 plafonnier; acier, laiton brossé / tissu, cappuccino, laiton

L 810, B 155, H 280



E14 3x 40W



9 002759 994860

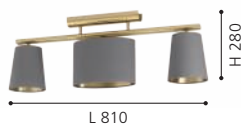

### 99612 ALMEIDA 2

floor light; steel, brushed brass / fabric, cappuccino, brass  
 Stehleuchte; Stahl, messing-gebürstet / Textil, cappuccino, messing  
 lampadaire; acier, laiton brossé / tissu, cappuccino, laiton

H 1670, Ø 320, Base: Ø 300



E27 3x 40W



9 002759 996123

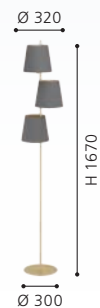



99612

### 99611 ALMEIDA 2

table light; steel, brushed brass / fabric, cappuccino, brass  
 Tischleuchte; Stahl, messing-gebürstet / Textil, cappuccino, messing  
 luminaire de table; acier, laiton brossé / tissu, cappuccino, laiton

H 605, Ø 260, Base: Ø 200



E27



2x 40W



9 002759 996116



99611

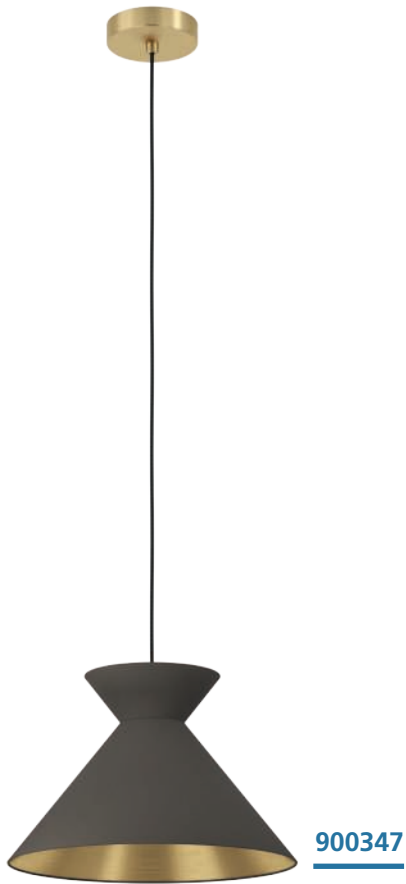

### 900347 NASTASIA

pendant light; steel, black / fabric, cappuccino, brass  
 Hängeleuchte; Stahl, schwarz / Textil, cappuccino, messing  
 luminaire en suspension; acier, noir / tissu, cappuccino, laiton

H 1100, Ø 380



### 900348 NASTASIA

pendant light; steel, black / fabric, cappuccino, brass  
 Hängeleuchte; Stahl, schwarz / Textil, cappuccino, messing  
 luminaire en suspension; acier, noir / tissu, cappuccino, laiton

L 1000, B 240, H 1100

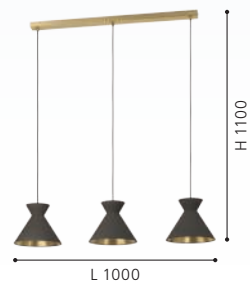





**900376**

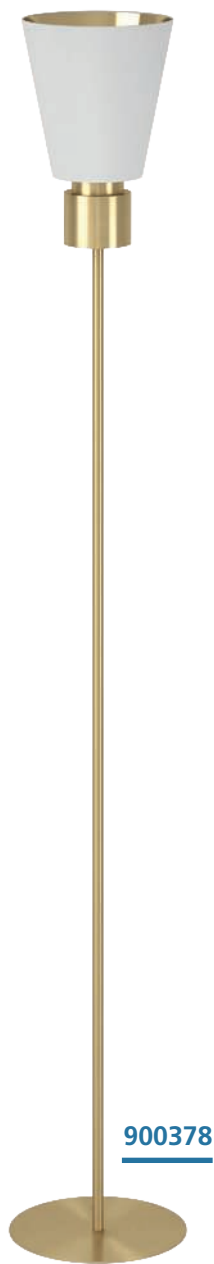

**900378**



**900377**

### 900376 AGLIENTINA

pendant light; steel, brushed brass / fabric, white, brass  
Hängeleuchte; Stahl, messing-gebürstet / Textil, weiss, messing  
luminaire en suspension; acier, laiton brossé / tissu, blanc, laiton

H 1100, Ø 200

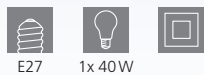

E27 1x 40W



9 008606 243587



### 900378 AGLIENTINA

floor light; steel, brushed brass / fabric, white, brass  
Stehleuchte; Stahl, messing-gebürstet / Textil, weiss, messing  
lampadaire; acier, laiton brossé / tissu, blanc, laiton

H 1700, Ø 200, Base: Ø 250



E27 1x 40W



9 008606 243600



### 900377 AGLIENTINA

pendant light; steel, brushed brass / fabric, white, brass  
Hängeleuchte; Stahl, messing-gebürstet / Textil, weiss, messing  
luminaire en suspension; acier, laiton brossé / tissu, blanc, laiton

L 900, B 200, H 1100



E27 3x 40W



9 008606 243594





**98587**



**98588**



**98587 ALMEIDA 1**

pendant light; steel, black / fabric, grey, white  
 Hängeleuchte; Stahl, schwarz / Textil, grau, weiss  
 luminaire en suspension; acier, noir / tissu, gris, blanc

L 860, B 255, H 1100



E14 3x 25W

**98588 ALMEIDA 1**

pendant light; steel, black / fabric, black, grey, white  
 Hängeleuchte; Stahl, schwarz / Textil, schwarz, grau, weiss  
 luminaire en suspension; acier, noir / tissu, noir, gris, blanc

L 1200, B 255, H 1100



E14 5x 25W



9 002759 985875



9 002759 985882





95192



95194



94995

### 95192 ALMEIDA

ceiling light; steel, black / fabric, anthracite, white, brown  
Deckenleuchte; Stahl, schwarz / Textil, anthrazit, weiss, braun  
plafonnier; acier, noir / tissu, anthracite, blanc, marron

H 350, Ø 590



E14 3x 40W



9 002759 951924

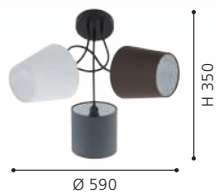

### 95194 ALMEIDA

table light; steel, black / fabric, white, anthracite  
Tischleuchte; Stahl, schwarz / Textil, weiss, anthrazit  
luminaire de table; acier, noir / tissu, blanc, anthracite

L 380, B 185, H 475, Base: Ø 155

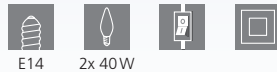

E14 2x 40W



9 002759 951948



### 94995 MARONDA

floor light; steel, black / fabric, anthracite, white, brown  
Stehleuchte; Stahl, schwarz / Textil, anthrazit, weiss, braun  
lampadaire; acier, noir / tissu, anthracite, blanc, marron

L 275, B 35, H 1520, Base: Ø 230

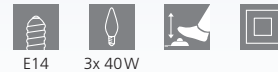

E14 3x 40W



9 002759 949952

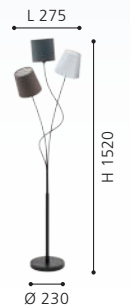

# LIGHTING FAMILIES

WOOD LUMINAIRES  
HOLZLEUCHTEN  
LUMINAIRES À BOIS

## SIMPLE CLASSINESS

The wood luminaires with their unusual designs are perfectly trendy and bring cosiness to every home. Our range of wood luminaires offers a great selection of various shapes, sizes and colours. It contains anything from suspended to table luminaires.

## SCHLICHTE ELEGANZ

Die Holzleuchten mit ihrem außergewöhnlichen Design sind voll im Trend und sorgen für Gemütlichkeit in jedem Zuhause. Unser Sortiment an Holzleuchten bietet eine große Auswahl an verschiedenen Formen, Größen sowie Farben und reicht von der Hänge- bis hin zur Tischleuchte.



## ÉLÉGANCE SIMPLE

Les luminaires en bois avec leur design extraordinaire sont très tendance et assurent un confort dans chaque maison. Notre gamme de luminaires en bois offre un grand choix de formes, de tailles et de couleurs différentes et s'étend des luminaires en suspension jusqu'aux luminaires de table.





# OVERVIEW

LIGHTING FAMILIES / WOOD



VELASCO  
p. 196-197



BAJAZZARA  
p. 198-199



RUSTICARIA  
p. 199



STELLATO 1  
p. 200-201



STELLATO 2  
p. 201-202



STELLATO 3  
p. 203



TINDORI  
p. 204-205



COSSANO  
p. 205-207



COSSANO 2  
p. 208



SENDERO  
p. 210-211



This product is available in different colors and shapes./ Dieser Artikel ist in unterschiedlichen Farben und Formen verfügbar.  
Cet article est disponible en différentes couleurs et formes.

# WOOD MATERIALS

## LAMELLA SHADES



wood, white  
Holz, weiß  
bois, blanc



wood, brown  
Holz, braun  
bois, marron



wood, maple  
Holz, ahorn  
bois, érable



wood, maple  
Holz, ahorn  
bois, érable



wood, brown  
Holz, braun  
bois, marron



wood, black  
Holz, schwarz  
bois, noir



wood, grey  
Holz, grau  
bois, gris



wood, nut  
Holz, nuss  
bois, noix



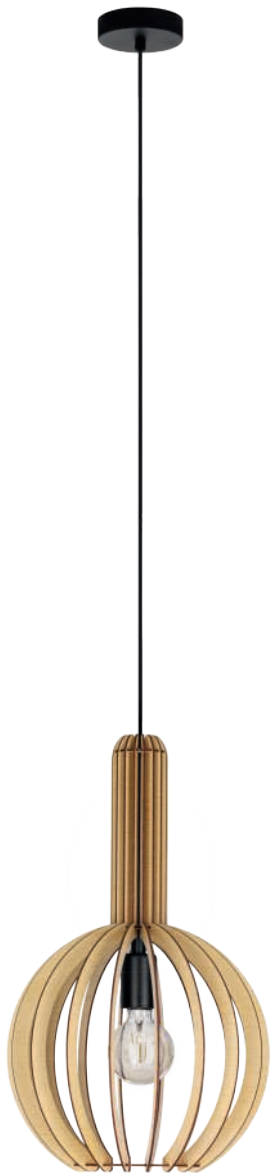

**900151**



**900152**

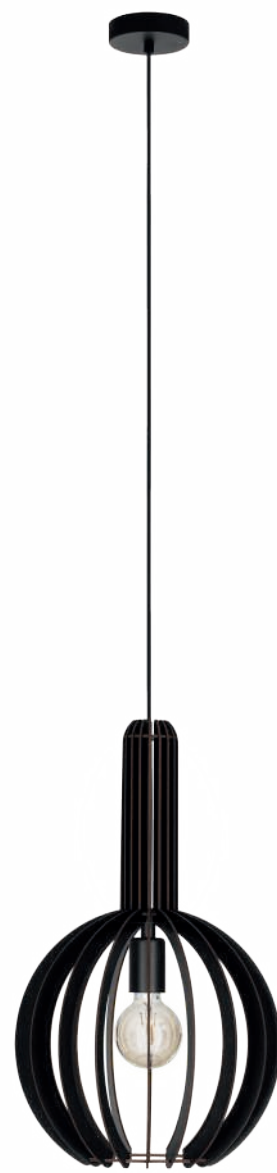

**900153**

### 900151 VELASCO

pendant light; steel, black / wood, maple  
 Hängeleuchte; Stahl, schwarz / Holz, ahorn  
 luminaire en suspension; acier, noir / bois, érable

H 1100, Ø 310

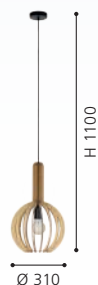
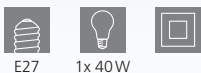

### 900152 VELASCO

pendant light; steel, black / wood, maple  
 Hängeleuchte; Stahl, schwarz / Holz, ahorn  
 luminaire en suspension; acier, noir / bois, érable

H 1100, Ø 380

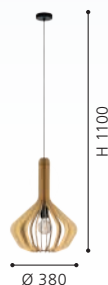
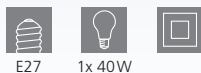

### 900153 VELASCO

pendant light; steel, black / wood, black  
 Hängeleuchte; Stahl, schwarz / Holz, schwarz  
 luminaire en suspension; acier, noir / bois, noir

H 1100, Ø 310







**900154**



### 900154 VELASCO

pendant light; steel, black / wood, black  
Hängeleuchte; Stahl, schwarz / Holz, schwarz  
luminaire en suspension; acier, noir / bois, noir

H 1100, Ø 380



E27



1x 40W



9 008606 224074

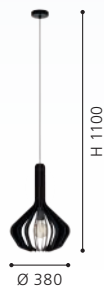



900503



900502



900504

### 900503 BAJAZZARA

pendant light; steel, black / wood, grey  
 Hängeleuchte; Stahl, schwarz / Holz, grau  
 luminaire en suspension; acier, noir / bois, gris

L 890, B 190, H 1100



E27



3x 40W



9 008606 244331



### 900502 BAJAZZARA

pendant light; steel, black / wood, grey  
 Hängeleuchte; Stahl, schwarz / Holz, grau  
 luminaire en suspension; acier, noir / bois, gris

H 1100, Ø 260



E27



1x 40W



9 008606 244324



### 900504 BAJAZZARA

pendant light; steel, black / wood, black  
 Hängeleuchte; Stahl, schwarz / Holz, schwarz  
 luminaire en suspension; acier, noir / bois, noir

H 1100, Ø 260



E27



1x 40W



9 008606 244348





900505



900385



900386



### 900505 BAJAZZARA

pendant light; steel, black / wood, black  
Hängeleuchte; Stahl, schwarz / Holz, schwarz  
luminaire en suspension; acier, noir / bois, noir

L 890, B 190, H 1100



### 900385 RUSTICARIA

ceiling light; steel, black / wood, glass, brown, white  
Deckenleuchte; Stahl, schwarz / Holz, Glas, braun, weiss  
plafonnier; acier, noir / bois, verre, marron, blanc

H 275, Ø 450



### 900386 RUSTICARIA

pendant light; steel, black / wood, glass, brown, white  
Hängeleuchte; Stahl, schwarz / Holz, Glas, braun, weiss  
luminaire en suspension; acier, noir / bois, verre, marron, blanc

H 1100, Ø 450

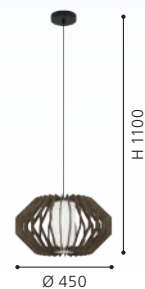



**95599**



**95598**



**95602**

### 95599 STELLATO 1

pendant light; steel, satin nickel / wood, glass, maple, white  
Hängeleuchte; Stahl, nickel-matt / Holz, Glas, ahorn, weiss  
luminaire en suspension; acier, nickel mat / bois, verre, érable, blanc

H 1500, Ø 500

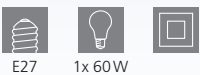

### 95598 STELLATO 1

pendant light; steel, satin nickel / wood, glass, maple, white  
Hängeleuchte; Stahl, nickel-matt / Holz, Glas, ahorn, weiss  
luminaire en suspension; acier, nickel mat / bois, verre, érable, blanc

H 1300, Ø 400

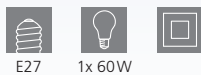

### 95602 STELLATO 1

wall light; steel, white / wood, glass, maple, white  
Wandleuchte; Stahl, weiss / Holz, Glas, ahorn, weiss  
applique; acier, blanc / bois, verre, érable, blanc

L 285, H 250, A 140

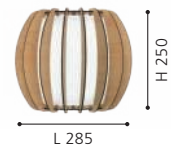





**95597**



STELLATO 1  
STELLATO 2



**95606**



**95607**

### 95597 STELLATO 1

ceiling light; steel, satin nickel / wood, glass, maple, white  
Deckenleuchte; Stahl, nickel-matt / Holz, Glas, ahorn, weiss  
plafonnier; acier, nickel mat / bois, verre, érable, blanc

H 275, Ø 400

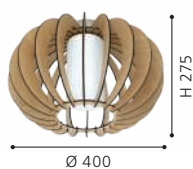

### 95606 STELLATO 2

pendant light; steel, white / wood, glass, white  
Hängeleuchte; Stahl, weiss / Holz, Glas, weiss  
luminaire en suspension; acier, blanc / bois, verre, blanc

H 1300, Ø 400

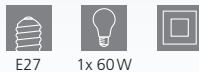

### 95607 STELLATO 2

pendant light; steel, white / wood, glass, white  
Hängeleuchte; Stahl, weiss / Holz, Glas, weiss  
luminaire en suspension; acier, blanc / bois, verre, blanc

H 1500, Ø 500

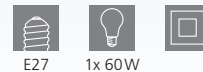

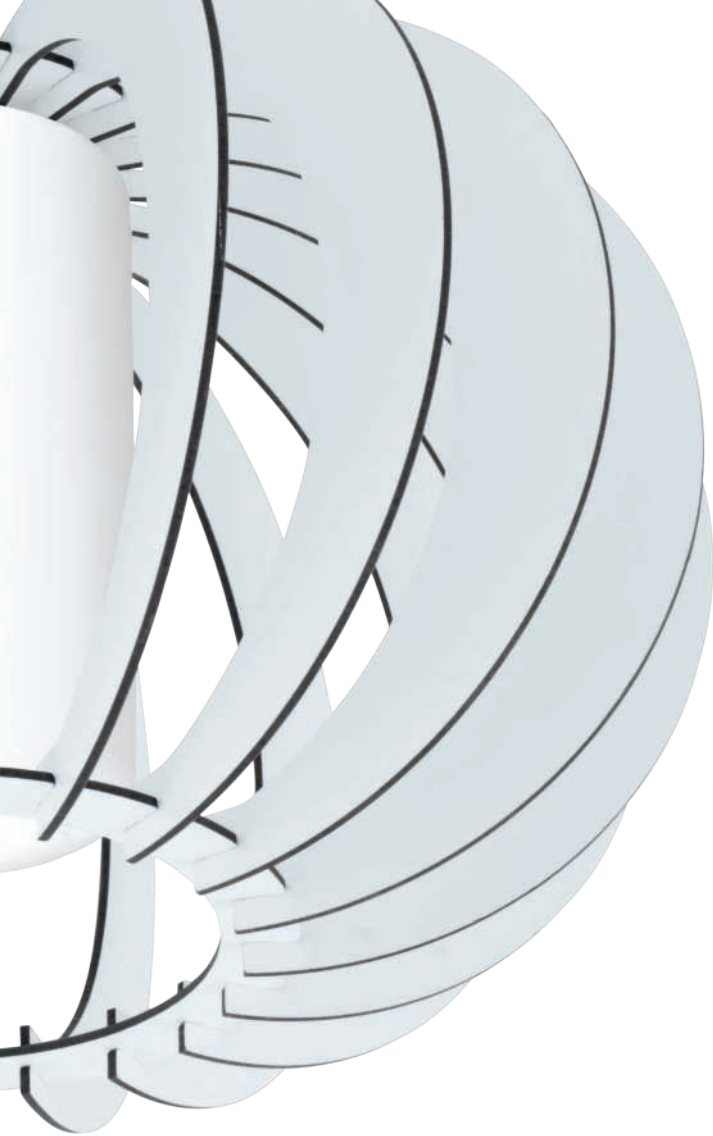

DESIGN  
HIGHLIGHT  
DETAIL

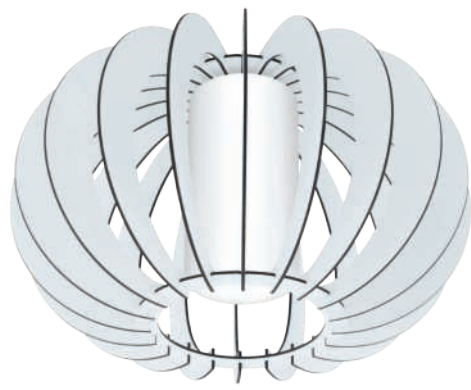

95605



95609



EGLO  
RECOMMENDS  
**110033**  
STELLATO 2  
STELLATO 3

**95609 STELLATO 2**

wall light; steel, white / wood, glass, white  
Wandleuchte; Stahl, weiss / Holz, Glas, weiss  
applique; acier, blanc / bois, verre, blanc

L 285, H 250, A 140



**95605 STELLATO 2**

ceiling light; steel, white / wood, glass, white  
Deckenleuchte; Stahl, weiss / Holz, Glas, weiss  
plafonnier; acier, blanc / bois, verre, blanc

H 275, Ø 400



9 002759 956097

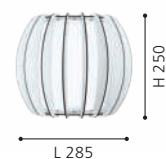

9 002759 956059

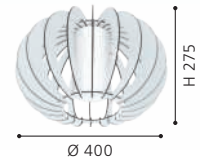



95591



95589



95594

### 95591 STELLATO 3

pendant light; steel, satin nickel / wood, glass, brown, white  
 Hängeleuchte; Stahl, nickel-matt / Holz, Glas, braun, weiss  
 luminaire en suspension; acier, nickel mat / bois, verre, marron, blanc

H 1300, Ø 400



9 002759 955915



### 95589 STELLATO 3

ceiling light; steel, satin nickel / wood, glass, brown, white  
 Deckenleuchte; Stahl, nickel-matt / Holz, Glas, braun, weiss  
 plafonnier; acier, nickel mat / bois, verre, marron, blanc

H 275, Ø 400



9 002759 955892

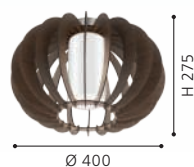

### 95594 STELLATO 3

wall light; steel, white / wood, glass, brown, white  
 Wandleuchte; Stahl, weiss / Holz, Glas, braun, weiss  
 applique; acier, blanc / bois, verre, marron, blanc

L 285, H 250, A 140



9 002759 955946

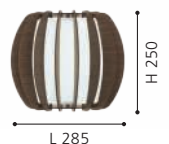



96211 | 96214

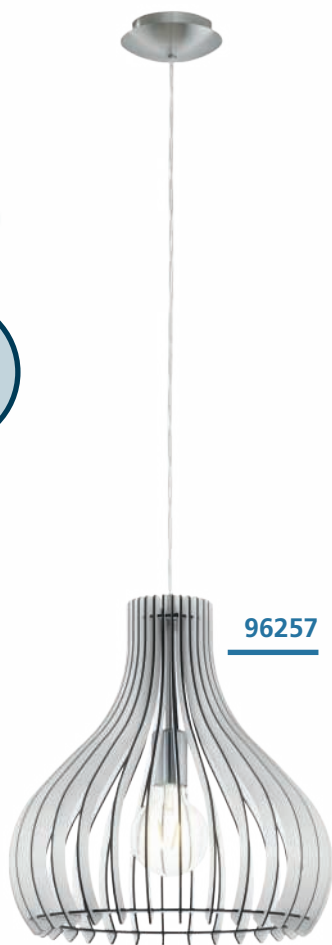

96257



96211



96258

### 96257 TINDORI

pendant light; steel, satin nickel / wood, white  
Hängeleuchte; Stahl, nickel-matt / Holz, weiss  
luminaire en suspension; acier, nickel mat / bois, blanc

H 1300, Ø 380

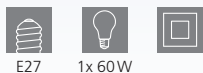

9 002759 962579



### 96211 TINDORI

pendant light; steel, satin nickel / wood, glass, white  
Hängeleuchte; Stahl, nickel-matt / Holz, Glas, weiss  
luminaire en suspension; acier, nickel mat / bois, verre, blanc

H 1500, Ø 500



9 002759 962111



### 96258 TINDORI

pendant light; steel, satin nickel / wood, maple  
Hängeleuchte; Stahl, nickel-matt / Holz, ahorn  
luminaire en suspension; acier, nickel mat / bois, érable

H 1300, Ø 380



9 002759 962586







**96214**



**94438**



**94442**

### 96214 TINDORI

pendant light; steel, satin nickel / wood, glass, maple, white  
 Hängeleuchte; Stahl, nickel-matt / Holz, Glas, ahorn, weiss  
 luminaire en suspension; acier, nickel mat / bois, verre, érable, blanc

H 1500, Ø 500



9 002759 962142

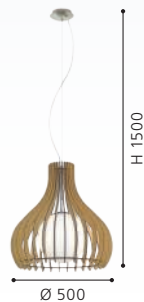

### 94438 COSSANO

pendant light; steel, white / wood, white  
 Hängeleuchte; Stahl, weiss / Holz, weiss  
 luminaire en suspension; acier, blanc / bois, blanc

H 1300, Ø 300

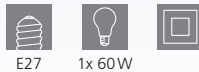

9 002759 944384



### 94442 COSSANO

pendant light; steel, white / wood, white  
 Hängeleuchte; Stahl, weiss / Holz, weiss  
 luminaire en suspension; acier, blanc / bois, blanc

H 1500, Ø 450

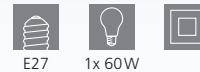

9 002759 944421





**94635**

**94636**

**94635 COSSANO**

pendant light; steel, satin nickel / wood, brown  
 Hängeleuchte; Stahl, nickel-matt / Holz, braun  
 luminaire en suspension; acier, nickel mat / bois, marron

H 1300, Ø 300

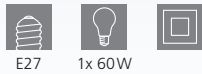

**94636 COSSANO**

pendant light; steel, satin nickel / wood, brown  
 Hängeleuchte; Stahl, nickel-matt / Holz, braun  
 luminaire en suspension; acier, nickel mat / bois, marron

H 1500, Ø 500

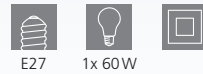

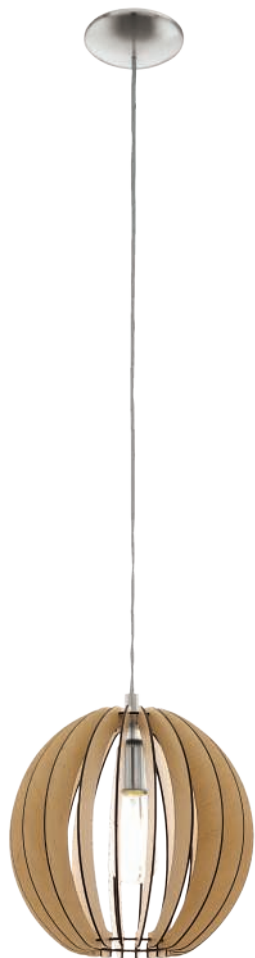

94764



94765

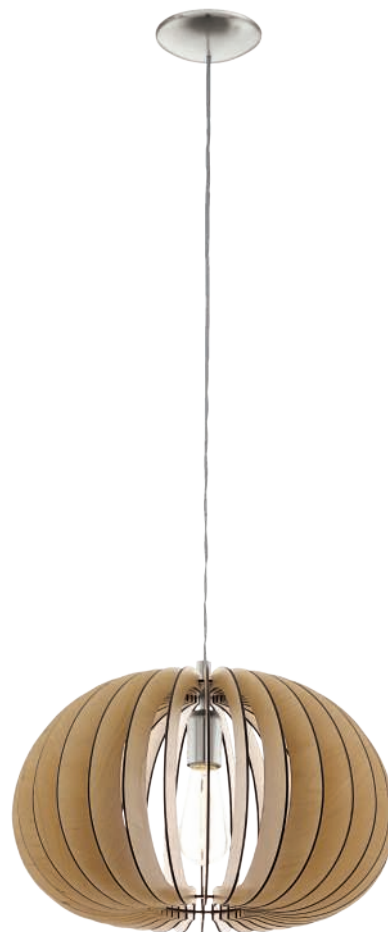

94767

### 94764 COSSANO

pendant light; steel, satin nickel / wood, maple  
Hängeleuchte; Stahl, nickel-matt / Holz, ahorn  
luminaire en suspension; acier, nickel mat / bois, érable

H 1300, Ø 300

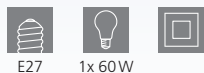

E27 1x 60W



9 002759 947644



### 94765 COSSANO

pendant light; steel, satin nickel / wood, maple  
Hängeleuchte; Stahl, nickel-matt / Holz, ahorn  
luminaire en suspension; acier, nickel mat / bois, érable

H 1500, Ø 500

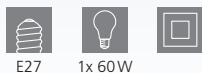

E27 1x 60W



9 002759 947651



### 94767 COSSANO

pendant light; steel, satin nickel / wood, maple  
Hängeleuchte; Stahl, nickel-matt / Holz, ahorn  
luminaire en suspension; acier, nickel mat / bois, érable

H 1500, Ø 450



E27 1x 60W



9 002759 947675



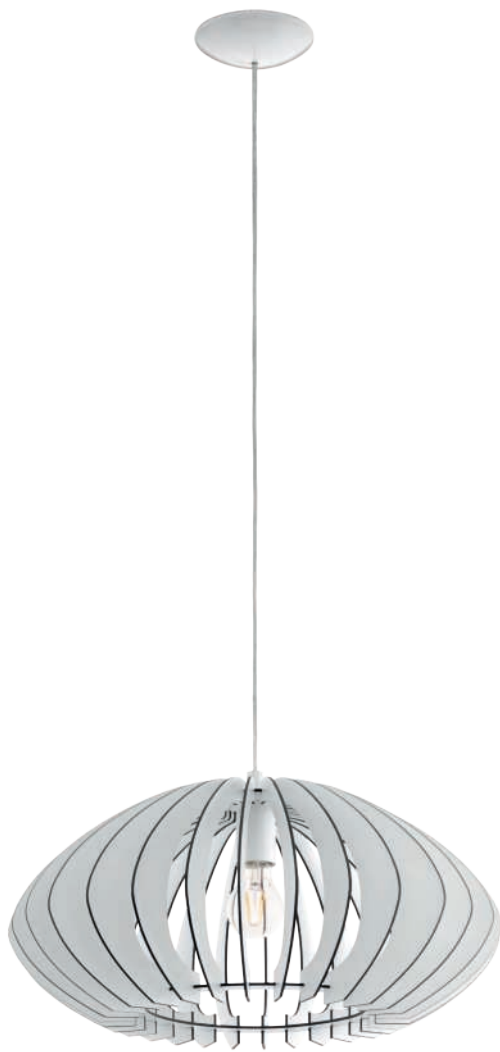

**95254**

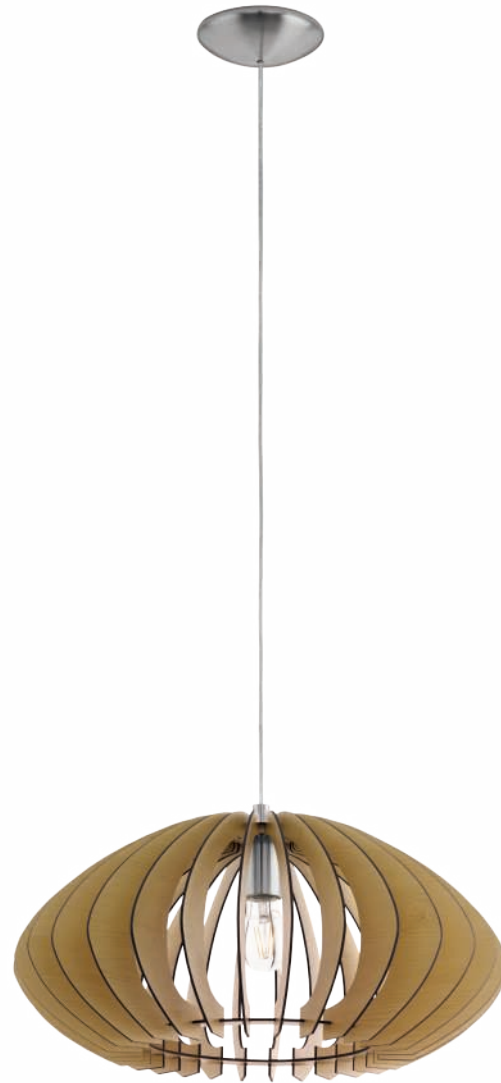

**95257**

**95254 COSSANO 2**

pendant light; steel, white / wood, white  
 Hängeleuchte; Stahl, weiss / Holz, weiss  
 luminaire en suspension; acier, blanc / bois, blanc

H 1500, Ø 500

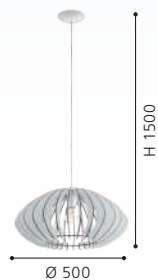
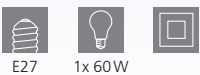

**95257 COSSANO 2**

pendant light; steel, satin nickel / wood, maple  
 Hängeleuchte; Stahl, nickel-matt / Holz, ahorn  
 luminaire en suspension; acier, nickel mat / bois, érable

H 1500, Ø 500

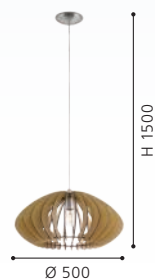
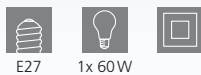

**95261 COSSANO 2**

pendant light; steel, satin nickel / wood, dark brown  
 Hängeleuchte; Stahl, nickel-matt / Holz, dunkelbraun  
 luminaire en suspension; acier, nickel mat / bois, marron foncé

H 1500, Ø 500

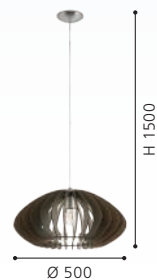





95261





96194



96195



96193

### 96194 SENDERO

pendant light; steel, satin nickel / wood, maple  
Hängeleuchte; Stahl, nickel-matt / Holz, ahorn  
luminaire en suspension; acier, nickel mat / bois, érable

L 775, B 250, H 1300



E27



2x 60W



9 002759 961947



### 96193 SENDERO

pendant light; steel, satin nickel / wood, maple  
Hängeleuchte; Stahl, nickel-matt / Holz, ahorn  
luminaire en suspension; acier, nickel mat / bois, érable

H 1300, Ø 450



E27



1x 60W



9 002759 961930



### 96195 SENDERO

wall light; steel, white / wood, maple  
Wandleuchte; Stahl, weiss / Holz, ahorn  
applique; acier, blanc / bois, érable

L 240, H 220, A 120



E27



1x 60W



9 002759 961954





**96199**



**96201**

### 96199 SENDERO

pendant light; steel, satin nickel / wood, brown  
 Hängeleuchte; Stahl, nickel-matt / Holz, braun  
 luminaire en suspension; acier, nickel mat / bois, marron

H 1300, Ø 450



E27 1x 60W



### 96201 SENDERO

pendant light; steel, satin nickel / wood, brown  
 Hängeleuchte; Stahl, nickel-matt / Holz, braun  
 luminaire en suspension; acier, nickel mat / bois, marron

L 775, B 250, H 1300

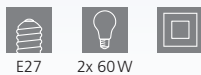

E27 2x 60W





# LIGHTING FAMILIES

STANDARD LUMINAIRES  
STANDARD LEUCHTEN  
LUMINAIRES STANDARD

## FAMILY MEETING

This range combines ceiling, wall, suspended, floor and table luminaires. Give your rooms a consistent and stylish all-round illumination.

## FAMILIENTREFFEN

Dieses Sortiment vereint sowohl Decken-, Wand- und Hängeleuchten als auch Tisch- und Stehleuchten. Verleihen Sie Ihren Räumlichkeiten eine einheitliche und stilvolle Rundumbeleuchtung.



## RENCONTRE FAMILIALE











Cette gamme réunit aussi bien des plafonniers, des éclairages muraux, des éclairages suspendus que des lampes de table et des lampadaires. Donnez à vos pièces un éclairage d'ensemble unifié et riche en style.





# OVERVIEW

LIGHTING FAMILIES / STANDARD

 TURALDO p. 216	 LIBERTAD p. 218, 220	 LIBERTAD 1 p. 219	 CAMACHO p. 222-223	 BOYAL p. 224-227	 PANAGRIA p. 228-229	 CANTERRAS p. 230-231	 ABREOSA p. 232
 CASIBARE p. 234-235	 CREMELLA p. 236-237	 ROMAZZINA p. 238-241	 VENEZUELA p. 242-243	 ESCANDIDOS p. 244-245	 LURONE p. 246-247	 NARICES p. 248-249	 ERSEKA p. 250-251
 MANZANARES p. 252-253	 RONDO p. 254-255	 RONDO 3 p. 256	 OPTICA p. 258-260	 GOROSIBA 1 p. 262	 GOROSIBA p. 262-263	 PINTO TEXTIL 1 p. 264	 PINTO TEXTIL p. 266-267
 PINTO NERO p. 268	 PINTO GOLD p. 270-271	 PINTO p. 272-273	 TROY 3 p. 274-275	 RIVATO p. 276-277	 AMADORA p. 278	 BAYMAN p. 279	 VINOVO p. 280
 MURCIA p. 280-281	 SAVOY p. 282-283	 MARBELLA p. 284-285	 ERVIDEL p. 286-287	 CLAVELLINA p. 288-289	 ISIDRO p. 290-291	 CARANACOA p. 292-293	 BANDERILLAS p. 294-295
 ALAMEDILLA p. 294	 CODRIALES p. 296-297	 SIBERIA p. 298-299	 LEJIAS p. 300-301	 LASANA 1 p. 302, 307	 LASANA 2 p. 302-303	 LASANA 3 p. 304-305	 LASANA p. 306



This product is available in different colors and shapes./ Dieser Artikel ist in unterschiedlichen Farben und Formen verfügbar.  
Cet article est disponible en différentes couleurs et formes.



TARANDELL  
p. 307



RONCADE 1  
p. 308



SELVINA 1  
p. 308



RONCADE  
p. 309, 313



SELVINA  
p. 309-310, 312



VALMORA  
p. 310-311

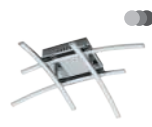

NEVADO  
p. 311



PALOZZA 1  
p. 312



PALOZZA  
p. 314-315





DESIGN  
HIGHLIGHT  
DETAIL



99077



99079

### 99077 TURALDO

ceiling light; wood, brown  
Deckenleuchte; Holz, braun  
plafonnier; bois, marron

H 80, Ø 70



E27



1x 28W



9 002759 990770

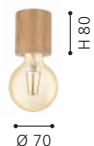

### 99079 TURALDO

table light; wood, brown  
Tischleuchte; Holz, braun  
luminaire de table; bois, marron

H 100, Ø 85



E27



1x 28W



9 002759 990794



### 99078 TURALDO

pendant light; wood, steel, brown, black  
Hängeleuchte; Holz, Stahl, braun, schwarz  
luminaire en suspension; bois, acier, marron, noir

H 1100, Ø 105



E27



1x 28W



9 002759 990787

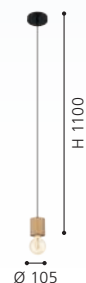





99078

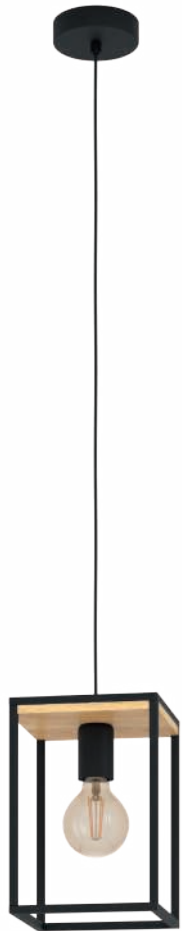

99795



99856



99855



### 99795 LIBERTAD

pendant light; steel, wood, black, brown  
Hängeleuchte; Stahl, Holz, schwarz, braun  
luminaire en suspension; acier, bois, noir, marron

L 180, B 180, H 1100



E27

1x 40W



9 002759 997953



### 99855 LIBERTAD

pendant light; steel, wood, black, brown  
Hängeleuchte; Stahl, Holz, schwarz, braun  
luminaire en suspension; acier, bois, noir, marron

L 880, B 180, H 1100



E27

3x 40W



9 002759 998554



### 99856 LIBERTAD

ceiling light; steel, wood, black, brown  
Deckenleuchte; Stahl, Holz, schwarz, braun  
plafonnier; acier, bois, noir, marron

L 860, B 180, H 240



E27

3x 40W



9 002759 998561







900349



### 900349 LIBERTAD 1

pendant light; steel, wood, black, brown  
 Hängeleuchte; Stahl, Holz, schwarz, braun  
 luminaire en suspension; acier, bois, noir, marron

L 760, B 140, H 1100



E27



3x 40W



9 008606 243501

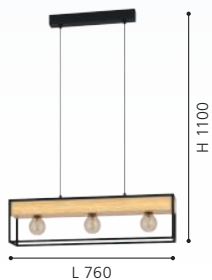

### 900349

The flower pots are included with this luminaire.

Bei dieser Leuchte sind die Blumentöpfe inkludiert.

Les pots de fleurs sont inclus avec ce luminaire.





99796



99798



### 99796 LIBERTAD

wall light; steel, wood, black, brown  
Wandleuchte; Stahl, Holz, schwarz, braun  
applique; acier, bois, noir, marron

L 140, H 240, A 165



E27 1x 40W



9 002759 997960



### 99798 LIBERTAD

floor light; steel, wood, black, brown  
Stehleuchte; Stahl, Holz, schwarz, braun  
lampadaire; acier, bois, noir, marron

L 180, B 180, H 1285



E27 1x 40W



9 002759 997984



### 99797 LIBERTAD

table light; steel, wood, black, brown  
Tischleuchte; Stahl, Holz, schwarz, braun  
luminaire de table; acier, bois, noir, marron

L 140, B 140, H 350



E27 1x 40W



9 002759 997977







99797





### 99293 CAMACHO

pendant light; steel, wood, black, brown / plastic, white  
 Hängeleuchte; Stahl, Holz, schwarz, braun / Kunststoff, weiss  
 luminaire en suspension; acier, bois, noir, marron / plastique, blanc

L 1100, B 60, H 1100



25,5W 3100lm



9 002759 992934

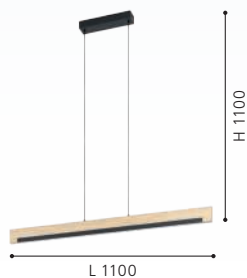

### 99292 CAMACHO

ceiling light; steel, wood, black, brown / plastic, white  
 Deckenleuchte; Stahl, Holz, schwarz, braun / Kunststoff, weiss  
 plafonnier; acier, bois, noir, marron / plastique, blanc

L 940, B 80, H 115



2x 10W 2600lm



9 002759 992927

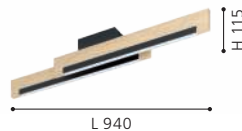

### 99294 CAMACHO

wall light; steel, wood, black, brown / plastic, white  
 Wandleuchte; Stahl, Holz, schwarz, braun / Kunststoff, weiss  
 applique; acier, bois, noir, marron / plastique, blanc

L 440, H 105, A 75



1x 9,6W 1050lm



9 002759 992941





TOUCH  
ME



99296

LED



99295

LED

### 99295, 99296

These luminaires can be switched on and off by touching the specially designed "Touch Me" part of the fixture.

Diese Leuchten können ein- und ausgeschaltet werden, indem man sie an den dafür vorgesehenen "Touch Me" Bereichen berührt.

Ces luminaires peuvent être éteints et allumés simplement en touchant la partie spécialement conçue pour "Touch Me" du luminaire.

### 99296 CAMACHO

floor light; steel, wood, black, brown / plastic, white  
Stehleuchte; Stahl, Holz, schwarz, braun / Kunststoff, weiss  
lampadaire; acier, bois, noir, marron / plastique, blanc

L 75, B 20, H 1260, Base: B 250, T 200

LED

19,5 W

warm  
WHITE

2400lm



9 002759 992965

### 99295 CAMACHO

table light; steel, wood, black, brown / plastic, white  
Tischleuchte; Stahl, Holz, schwarz, braun / Kunststoff, weiss  
luminaire de table; acier, bois, noir, marron / plastique, blanc

L 75, B 20, H 405, Base: B 150, T 130

LED

1x 6,5 W

warm  
WHITE

800lm



9 002759 992958



### 99624 BOYAL

pendant light; steel, wood, black, brown rustic / plastic, white  
 Hängeleuchte; Stahl, Holz, schwarz, braun rustikal / Kunststoff, weiss  
 luminaire en suspension; acier, bois, noir, marron rustique / plastique, blanc

L 1010, B 400, H 1100

LED warm WHITE 2x 12,5W 3600lm LED warm WHITE 1x 15,5W 2250lm



9 002759 996246

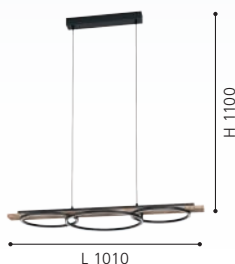

### 99413 BOYAL

ceiling light; steel, wood, black, brown rustic / plastic, white  
 Deckenleuchte; Stahl, Holz, schwarz, braun rustikal / Kunststoff, weiss  
 plafonnier; acier, bois, noir, marron rustique / plastique, blanc

L 1010, B 400, H 95

LED warm WHITE 2x 12W 3400lm LED warm WHITE 1x 12W 1700lm



9 002759 994136

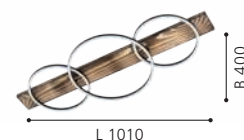





99353



99457



99408



### 99353 BOYAL

wall light; steel, wood, black, brown rustic / plastic, white  
Wandleuchte; Stahl, Holz, schwarz, braun rustikal / Kunststoff, weiss  
applique; acier, bois, noir, marron rustique / plastique, blanc

L 300, H 560, A 75



1x 12W 1700lm



9 002759 993535



### 99457 BOYAL

table light; steel, wood, black, brown rustic / plastic, white  
Tischleuchte; Stahl, Holz, schwarz, braun rustikal / Kunststoff, weiss  
luminaire de table; acier, bois, noir, marron rustique / plastique, blanc

L 300, B 150, H 425, Base: B 110, T 150



1x 12W 1700lm



9 002759 994570



### 99408 BOYAL

ceiling light; steel, wood, black, brown rustic / plastic, white  
Deckenleuchte; Stahl, Holz, schwarz, braun rustikal / Kunststoff, weiss  
plafonnier; acier, bois, noir, marron rustique / plastique, blanc

L 780, B 400, H 90



1x 12W 1700lm 1x 12W 1700lm



9 002759 994082





### 99625 BOYAL

pendant light; steel, black, brown / plastic, white  
 Hängeleuchte; Stahl, schwarz, braun / Kunststoff, weiss  
 luminaire en suspension; acier, noir, marron / plastique, blanc

L 1010, B 400, H 1100

LED warm WHITE LED warm WHITE

2x 12,5W 3600lm 1x 15,5W 2250lm



9 002759 996253



### 99468 BOYAL

ceiling light; steel, wood, black, brown / plastic, white  
 Deckenleuchte; Stahl, Holz, schwarz, braun / Kunststoff, weiss  
 plafonnier; acier, bois, noir, marron / plastique, blanc

L 1010, B 400, H 95

LED warm WHITE LED warm WHITE

2x 12W 3400lm 1x 12W 1700lm



9 002759 994686

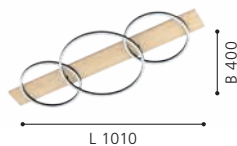

### 99467 BOYAL

ceiling light; steel, wood, black, brown / plastic, white  
 Deckenleuchte; Stahl, Holz, schwarz, braun / Kunststoff, weiss  
 plafonnier; acier, bois, noir, marron / plastique, blanc

L 780, B 400, H 90

LED warm WHITE LED warm WHITE

1x 12W 1700lm 1x 12W 1700lm



9 002759 994679

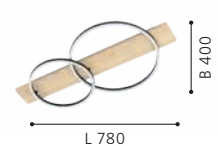



99469

LED



99466

LED

### 99469 BOYAL

table light; steel, wood, black, brown / plastic, white  
Tischleuchte; Stahl, Holz, schwarz, braun / Kunststoff, weiss  
luminaire de table; acier, bois, noir, marron / plastique, blanc

L 300, B 150, H 425, Base: B 110, T 150



1x 12W 1700lm



9 002759 994693



### 99466 BOYAL

wall light; steel, wood, black, brown / plastic, white  
Wandleuchte; Stahl, Holz, schwarz, braun / Kunststoff, weiss  
applique; acier, bois, noir, marron / plastique, blanc

L 300, H 560, A 75



1x 12W 1700lm



9 002759 994662







900489



900488



900491



### 900489 PANAGRIA

pendant light; aluminium, steel, wood, black, brown / plastic, white

Hängeleuchte; Alu, Stahl, Holz, schwarz, braun / Kunststoff, weiss

luminaire en suspension; aluminium, acier, bois, noir, marron / plastique, blanc

L 935, B 75, H 1100



2x 13W 3120lm



9 008606 244249

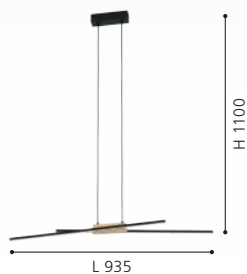

### 900488 PANAGRIA

ceiling light; aluminium, steel, wood, black, brown / plastic, white

Deckenleuchte; Alu, Stahl, Holz, schwarz, braun / Kunststoff, weiss

plafonnier; aluminium, acier, bois, noir, marron / plastique, blanc

L 935, B 75, H 110



2x 13W 3120lm



9 008606 244232

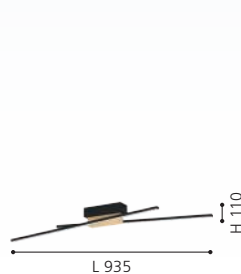

### 900491 PANAGRIA

wall light; aluminium, steel, wood, black, brown / plastic, white

Wandleuchte; Alu, Stahl, Holz, schwarz, braun / Kunststoff, weiss

applique; aluminium, acier, bois, noir, marron / plastique, blanc

L 75, H 540, A 85



2x 6,3W 1510lm



9 008606 244256







900492



900493



DESIGN  
HIGHLIGHT  
DETAIL

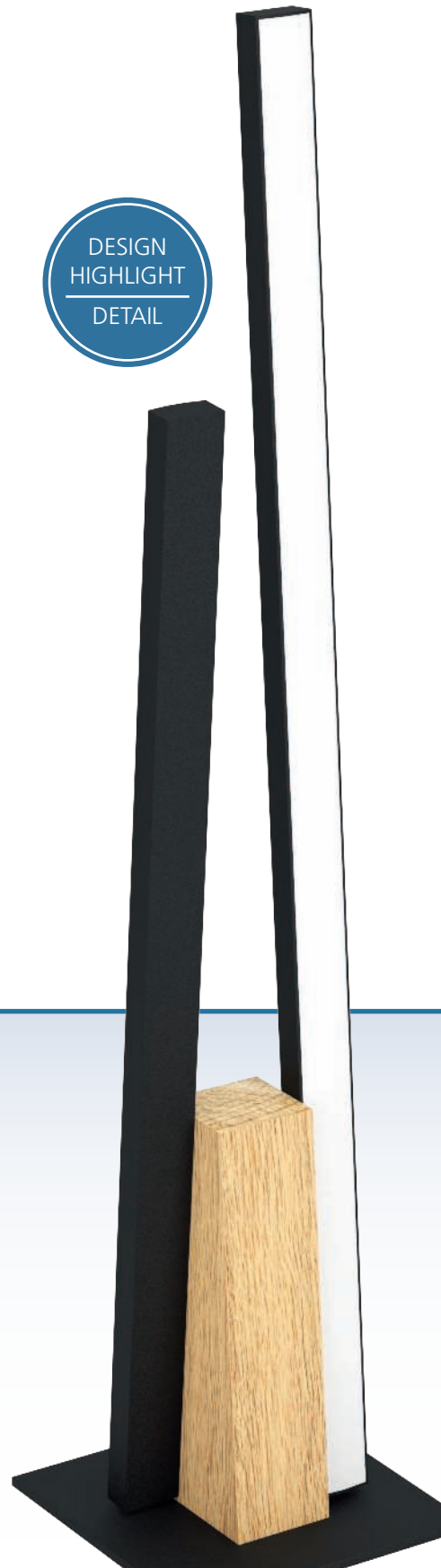

### 900492 PANAGRIA

table light; aluminium, steel, wood, black, brown / plastic, white  
Tischleuchte; Alu, Stahl, Holz, schwarz, braun / Kunststoff, weiss  
luminaire de table; aluminium, acier, bois, noir, marron /  
plastique, blanc

L 75, B 45, H 455, Base: B 100, T 100



1x 6,8W



1440lm



1x 5,2W



9 008606 244263



### 900493 PANAGRIA

floor light; aluminium, steel, wood, black, brown / plastic, white  
Stehleuchte; Alu, Stahl, Holz, schwarz, braun / Kunststoff, weiss  
lampadaire; aluminium, acier, bois, noir, marron / plastique,  
blanc

L 85, B 75, H 1460, Base: B 160, T 160



1x 12,8W



2880lm



1x 11,2W



9 008606 244270





99545

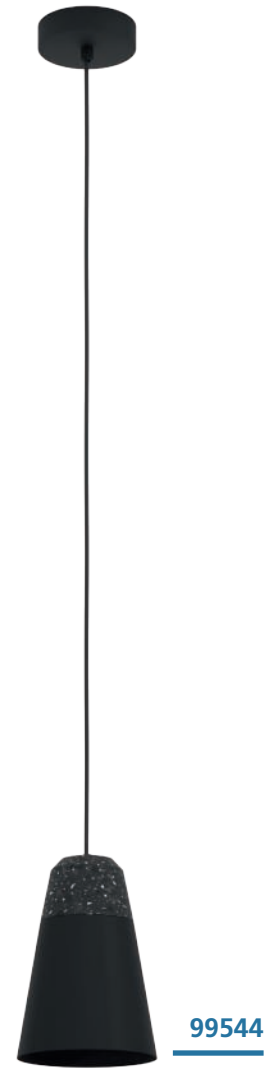

99544

### 99545 CANTERRAS

pendant light; steel, black / terrazzo, grey, white  
 Hängeleuchte; Stahl, schwarz / Terrazzo, grau, weiss  
 luminaire en suspension; acier, noir / terrazzo, gris, blanc

L 975, B 150, H 1100



### 99544 CANTERRAS

pendant light; steel, black / terrazzo, grey, white  
 Hängeleuchte; Stahl, schwarz / Terrazzo, grau, weiss  
 luminaire en suspension; acier, noir / terrazzo, gris, blanc

H 1100, Ø 150

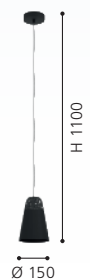



**99546**



**99547**



### 99546 CANTERRAS

wall light; steel, black / terrazzo, grey, white  
Wandleuchte; Stahl, schwarz / Terrazzo, grau, weiss  
applique; acier, noir / terrazzo, gris, blanc

L 150, H 320, A 275



9 002759 995461



### 99547 CANTERRAS

floor light; steel, black / terrazzo, grey, white  
Stehleuchte; Stahl, schwarz / Terrazzo, grau, weiss  
lampadaire; acier, noir / terrazzo, gris, blanc

L 430, B 150, H 1785, Base: Ø 300

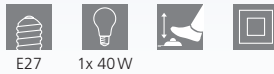

9 002759 995478



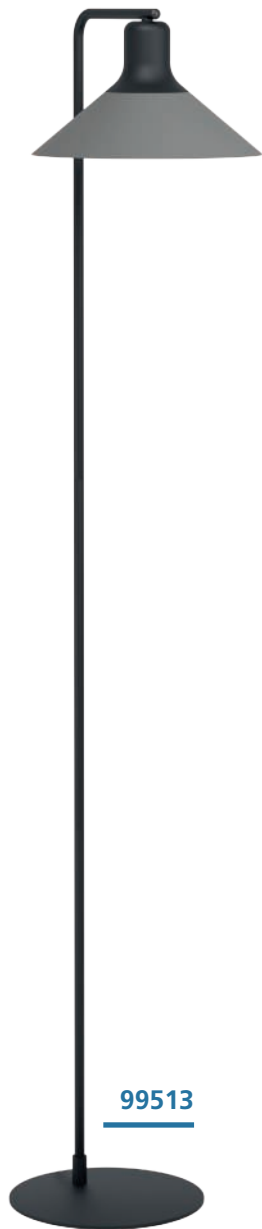

99513



99512

### 99513 ABREOSA

floor light; steel, black, grey  
Stehleuchte; Stahl, schwarz, grau  
lampadaire; acier, noir, gris

L 370, B 280, H 1510, Base: Ø 250

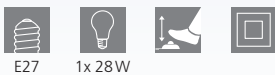

E27 1x 28W



### 99512 ABREOSA

pendant light; steel, black, grey  
Hängeleuchte; Stahl, schwarz, grau  
luminaire en suspension; acier, noir, gris

L 1080, B 280, H 1100



E27 3x 28W



### 99511 ABREOSA

pendant light; steel, black, grey  
Hängeleuchte; Stahl, schwarz, grau  
luminaire en suspension; acier, noir, gris

H 1100, Ø 280

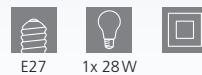

E27 1x 28W

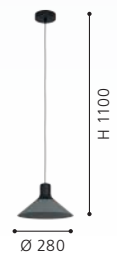





99511



99551



99552



99553

### 99551 CASIBARE

pendant light; steel, black  
Hängeleuchte; Stahl, schwarz  
luminaire en suspension; acier, noir

H 1100, Ø 150



9 002759 995515



### 99552 CASIBARE

pendant light; steel, black  
Hängeleuchte; Stahl, schwarz  
luminaire en suspension; acier, noir

L 850, B 150, H 1100



9 002759 995522



### 99553 CASIBARE

pendant light; steel, black  
Hängeleuchte; Stahl, schwarz  
luminaire en suspension; acier, noir

H 1500, Ø 710



9 002759 995539





99554



99555

### 99554 CASIBARE

table light; steel, black  
Tischleuchte; Stahl, schwarz  
luminaire de table; acier, noir

L 160, B 120, H 490, Base: Ø 155

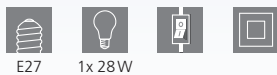

E27 1x 28W



9 002759 995546



### 99555 CASIBARE

floor light; steel, black  
Stehleuchte; Stahl, schwarz  
lampadaire; acier, noir

L 350, B 120, H 1605, Base: Ø 250

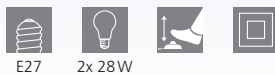

E27 2x 28W



9 002759 995553





99345



900164

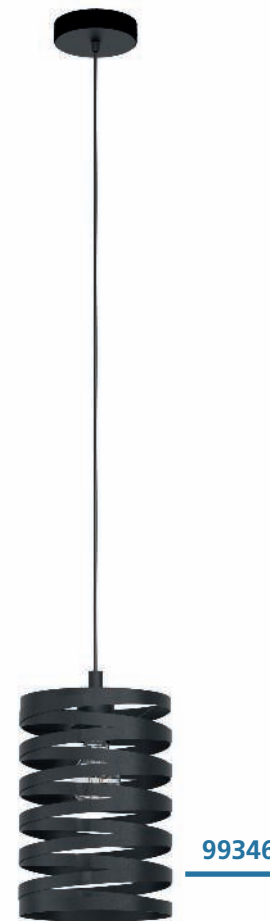

99346

### 99345 CREMELLA

pendant light; steel, black  
Hängeleuchte; Stahl, schwarz  
luminaire en suspension; acier, noir

H 1100, Ø 370



E27

1x 40W



9 002759 993450



### 900164 CREMELLA

ceiling light; steel, black  
Deckenleuchte; Stahl, schwarz  
plafonnier; acier, noir

H 260, Ø 370



E27

1x 60W



9 008606 234417

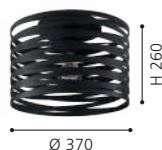

### 99346 CREMELLA

pendant light; steel, black  
Hängeleuchte; Stahl, schwarz  
luminaire en suspension; acier, noir

H 1100, Ø 180



E27

1x 40W



9 002759 993467





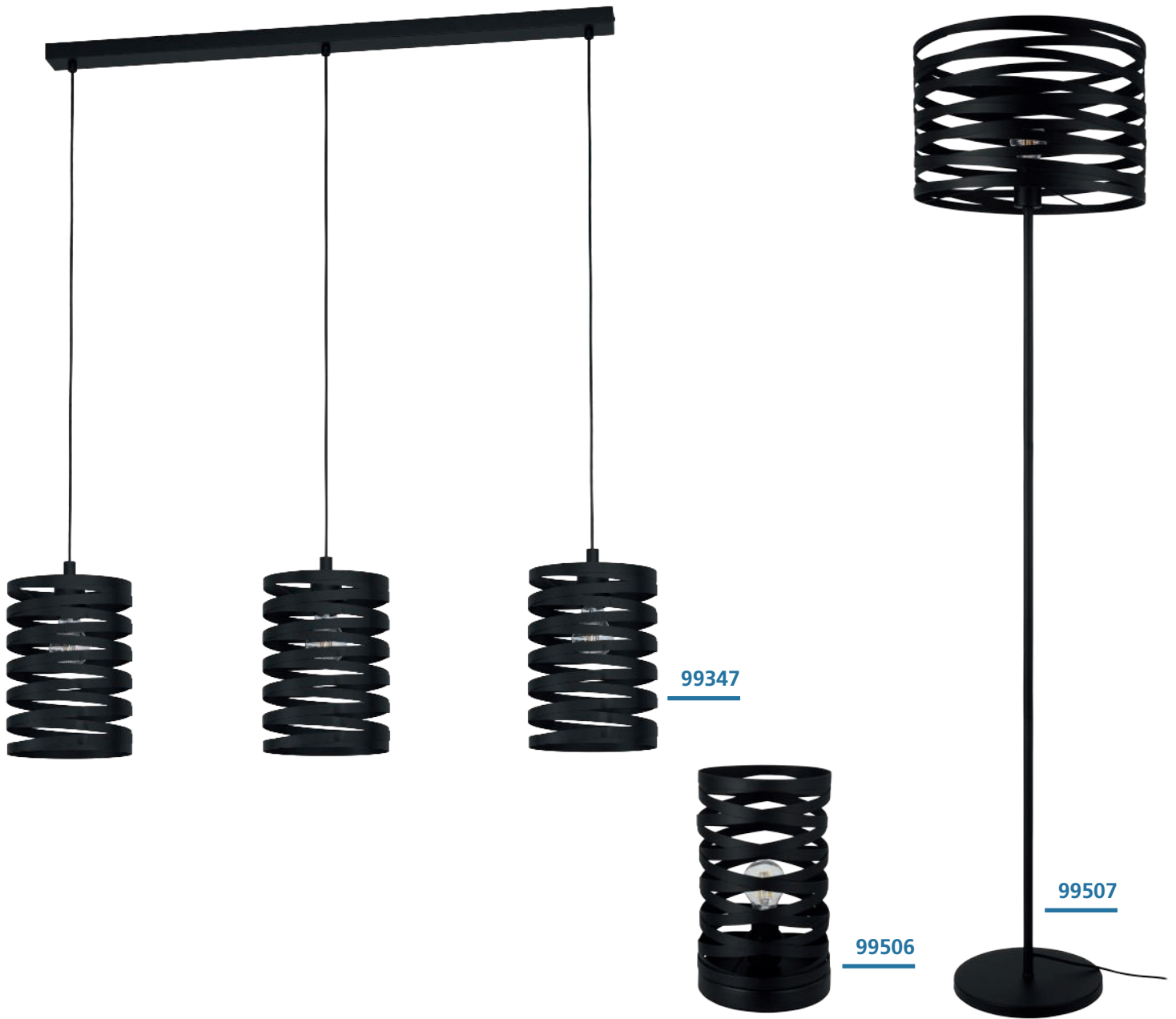

### 99347 CREMELLA

pendant light; steel, black  
 Hängeleuchte; Stahl, schwarz  
 luminaire en suspension; acier, noir

L 940, B 180, H 1100



E27 3x 40W



9 002759 993474

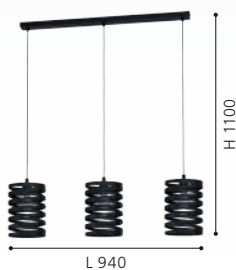

### 99506 CREMELLA

table light; steel, black  
 Tischleuchte; Stahl, schwarz  
 luminaire de table; acier, noir

H 290, Ø 180, Base: Ø 180



E27 1x 40W



9 002759 995065



### 99507 CREMELLA

floor light; steel, black  
 Stehleuchte; Stahl, schwarz  
 lampadaire; acier, noir

H 1510, Ø 370, Base: Ø 250



E27 1x 40W



9 002759 995072

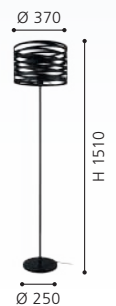



**900494**



**900495**

### 900494 ROMAZZINA

pendant light; steel, black  
Hängeleuchte; Stahl, schwarz  
luminaire en suspension; acier, noir

H 1100, Ø 325



E27 1x 40W



9 008606 244287



### 900495 ROMAZZINA

pendant light; steel, black  
Hängeleuchte; Stahl, schwarz  
luminaire en suspension; acier, noir

L 900, B 200, H 1100



E27 3x 40W



9 008606 244294



### 900519 ROMAZZINA

table light; steel, black  
Tischleuchte; Stahl, schwarz  
luminaire de table; acier, noir

H 435, Ø 200, Base: Ø 225

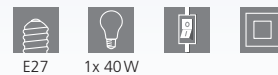

E27 1x 40W



9 008606 244485





**900519**



**900522**

**900522 ROMAZZINA**

floor light; steel, black  
 Stehleuchte; Stahl, schwarz  
 lampadaire; acier, noir

H 1405, Ø 325, Base: Ø 630



E27 1x 40W



9 008606 244508

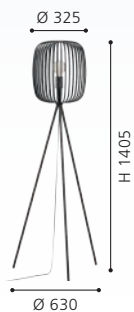



**900496**



### 900496 ROMAZZINA

pendant light; steel, sandy  
Hängeleuchte; Stahl, sandfarben  
luminaire en suspension; acier, couleur sable

H 1100, Ø 325



E27



1x 40W







### 900497 ROMAZZINA

pendant light; steel, sandy  
Hängeleuchte; Stahl, sandfarben  
luminaire en suspension; acier, couleur sable

L 900, B 200, H 1100



### 900521 ROMAZZINA

table light; steel, sandy  
Tischleuchte; Stahl, sandfarben  
luminaire de table; acier, couleur sable

H 435, Ø 200, Base: Ø 225



### 900523 ROMAZZINA

floor light; steel, sandy  
Stehleuchte; Stahl, sandfarben  
lampadaire; acier, couleur sable

H 1405, Ø 325, Base: Ø 630

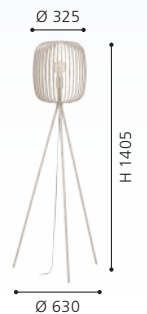



**900165**

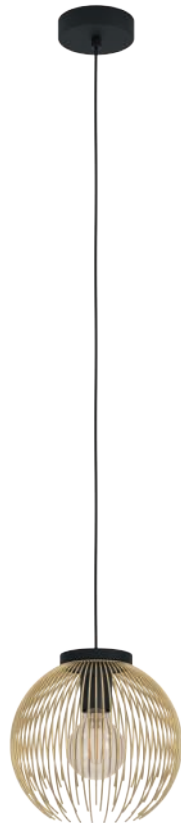

**900166**



**900167**

### 900165 VENEZUELA

ceiling light; steel, black, gold  
Deckenleuchte; Stahl, schwarz, gold  
plafonnier; acier, noir, or

H 250, Ø 385



E27 1x 40W



9 008606 242771



### 900166 VENEZUELA

pendant light; steel, black, gold  
Hängeleuchte; Stahl, schwarz, gold  
luminaire en suspension; acier, noir, or

H 1100, Ø 235

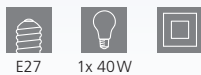

E27 1x 40W



9 008606 242788



### 900167 VENEZUELA

pendant light; steel, black, gold  
Hängeleuchte; Stahl, schwarz, gold  
luminaire en suspension; acier, noir, or

L 935, B 235, H 1100



E27 3x 40W



9 008606 242795





**900168**

**900168 VENEZUELA**

table light; steel, black, gold  
Tischleuchte; Stahl, schwarz, gold  
luminaire de table; acier, noir, or

H 225, Ø 235, Base: Ø 115



E27



1x 40W



9 008606 242801

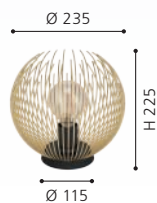





99806



99807



99809

### 99806 ESCANDIDOS

pendant light; steel, black, brass / steel, black, gold  
Hängeleuchte; Stahl, schwarz, messing / Stahl, schwarz, gold  
luminaire en suspension; acier, noir, laiton / acier, noir, or

H 1100, Ø 220



E27 1x 40W



9 002759 998066



### 99807 ESCANDIDOS

pendant light; steel, black, brass / steel, black, gold  
Hängeleuchte; Stahl, schwarz, messing / Stahl, schwarz, gold  
luminaire en suspension; acier, noir, laiton / acier, noir, or

L 920, B 220, H 1100



E27 3x 40W



9 002759 998073



### 99809 ESCANDIDOS

floor light; steel, black, brass / steel, black, gold  
Stehleuchte; Stahl, schwarz, messing / Stahl, schwarz, gold  
lampadaire; acier, noir, laiton / acier, noir, or

L 310, B 220, H 1700, Base: B 300, T 200



E27 1x 40W



9 002759 998097

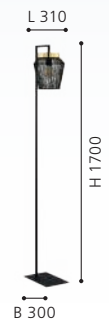





99808

### 99808 ESCANDIDOS

table light; steel, black, brass / steel, black, gold  
Tischleuchte; Stahl, schwarz, messing / Stahl, schwarz, gold  
luminaire de table; acier, noir, laiton / acier, noir, or

H 260, Ø 220, Base: Ø 150



E27



1x 40W



9 002759 998080





**900177**



DESIGN  
HIGHLIGHT  
DETAIL

### 900177 LURONE

pendant light; steel, black, brass  
Hängeleuchte; Stahl, schwarz, messing  
luminaire en suspension; acier, noir, laiton

L 1000, B 50, H 1100



E27



4x 10W

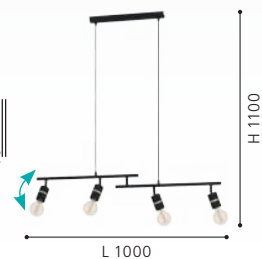



900176



900178



900179

### 900176 LURONE

ceiling light; steel, black, brass  
Deckenleuchte; Stahl, schwarz, messing  
plafonnier; acier, noir, laiton

L 1000, B 50, H 270

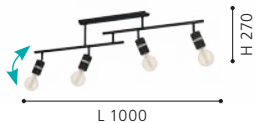

### 900178 LURONE

table light; steel, black, brass  
Tischleuchte; Stahl, schwarz, messing  
luminaire de table; acier, noir, laiton

L 205, B 50, H 500, Base: Ø 200



### 900179 LURONE

floor light; steel, black, brass  
Stehleuchte; Stahl, schwarz, messing  
lampadaire; acier, noir, laiton

L 205, B 50, H 1600, Base: Ø 250

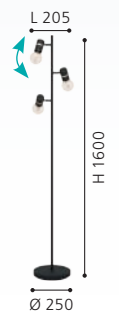
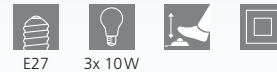





99592



DESIGN  
HIGHLIGHT  
DETAIL

**99592 NARICES**

pendant light; steel, black / steel, brushed brass, gold  
Hängeleuchte; Stahl, schwarz / Stahl, messing-gebürstet, gold  
luminaire en suspension; acier, noir / acier, laiton brossé, or

L 920, B 220, H 1100



E27



3x 40W

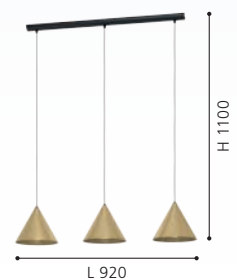



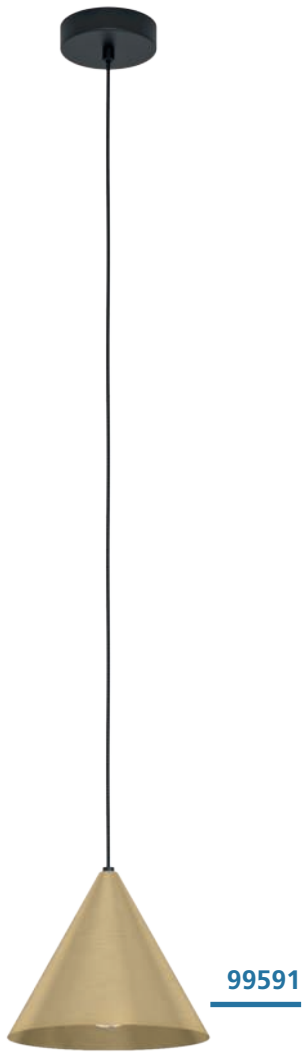

99591



99593



99594

### 99591 NARICES

pendant light; steel, black / steel, brushed brass, gold  
Hängeleuchte; Stahl, schwarz / Stahl, messing-gebürstet, gold  
luminaire en suspension; acier, noir / acier, laiton brossé, or

H 1100, Ø 220



E27 1x 40W



9 002759 995911



### 99593 NARICES

table light; steel, black / steel, brushed brass, gold  
Tischleuchte; Stahl, schwarz / Stahl, messing-gebürstet, gold  
luminaire de table; acier, noir / acier, laiton brossé, or

L 295, B 220, H 500, Base: Ø 220



E27 1x 40W



9 002759 995935



### 99594 NARICES

floor light; steel, black / steel, brushed brass, gold  
Stehleuchte; Stahl, schwarz / Stahl, messing-gebürstet, gold  
lampadaire; acier, noir / acier, laiton brossé, or

L 295, B 220, H 1620, Base: Ø 270

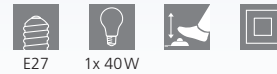

E27 1x 40W



9 002759 995942





99098



99096



99097

### 99098 ERSEKA

pendant light; steel, brass / brilliant glass, clear  
 Hängeleuchte; Stahl, messing / Brillantglas, klar  
 luminaire en suspension; acier, laiton / verre brillant, transparent

H 1300, Ø 385



9 002759 990985



### 99097 ERSEKA

pendant light; steel, brass / brilliant glass, clear  
 Hängeleuchte; Stahl, messing / Brillantglas, klar  
 luminaire en suspension; acier, laiton / verre brillant, transparent

H 1450, Ø 485



9 002759 990978



### 99096 ERSEKA

ceiling light; steel, brass / brilliant glass, clear  
 Deckenleuchte; Stahl, messing / Brillantglas, klar  
 plafonnier; acier, laiton / verre brillant, transparent

H 535, Ø 485



9 002759 990961

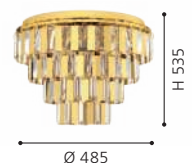



99095



99093



99094



ERSEKA

### 99095 ERSEKA

pendant light; steel, chrome / brilliant glass, clear  
Hängeleuchte; Stahl, chrom / Brillantglas, klar  
luminaire en suspension; acier, chrome / verre brillant, transparent

H 1300, Ø 385



E14 5x 40W



9 002759 990954



### 99094 ERSEKA

pendant light; steel, chrome / brilliant glass, clear  
Hängeleuchte; Stahl, chrom / Brillantglas, klar  
luminaire en suspension; acier, chrome / verre brillant, transparent

H 1450, Ø 485

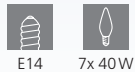

E14 7x 40W



9 002759 990947



### 99093 ERSEKA

ceiling light; steel, chrome / brilliant glass, clear  
Deckenleuchte; Stahl, chrom / Brillantglas, klar  
plafonnier; acier, chrome / verre brillant, transparent

H 535, Ø 485



E14 7x 40W



9 002759 990930

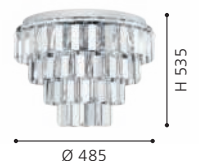



**900305**



MANZANARES

### 900305 MANZANARES

pendant light; steel, brushed brass, gold / glass opal-matt, white  
Hängeleuchte; Stahl, messing-gebürstet, gold / Glas opal-matt, weiss

luminaire en suspension; acier, laiton brossé, or / verre opale mat, blanc

H 1100, Ø 225



E27



1x 40W



9 008606 235902

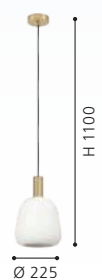





### 900306 MANZANARES

pendant light; steel, brushed brass, gold / glass opal-matt, white  
Hängeleuchte; Stahl, messing-gebürstet, gold / Glas opal-matt, weiss

luminaire en suspension; acier, laiton brossé, or / verre opale mat, blanc

L 970, B 145, H 1100



E27 4x 40W

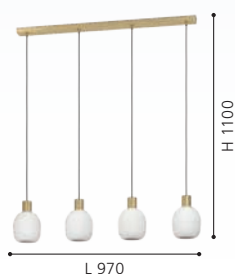

### 900304 MANZANARES

ceiling light; steel, brushed brass, gold / glass opal-matt, white  
Deckenleuchte; Stahl, messing-gebürstet, gold / Glas opal-matt, weiss

plafonnier; acier, laiton brossé, or / verre opale mat, blanc

H 190, Ø 450



E27 3x 40W

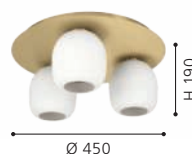

### 900307 MANZANARES

table light; steel, brushed brass, gold / glass opal-matt, white  
Tischleuchte; Stahl, messing-gebürstet, gold / Glas opal-matt, weiss

luminaire de table; acier, laiton brossé, or / verre opale mat, blanc

H 180, Ø 145, Base: Ø 90

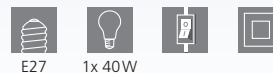

E27 1x 40W





85261



85262

### 85261 RONDO

pendant light; steel, satin nickel / glass opal-matt, white  
 Hängeleuchte; Stahl, nickel-matt / Glas opal-matt, weiss  
 luminaire en suspension; acier, nickel mat / verre opale mat, blanc

H 1100, Ø 200



E27



1x 60W



9 002759 852610



### 85262 RONDO

pendant light; steel, satin nickel / glass opal-matt, white  
 Hängeleuchte; Stahl, nickel-matt / Glas opal-matt, weiss  
 luminaire en suspension; acier, nickel mat / verre opale mat, blanc

H 1100, Ø 250



E27



1x 60W



9 002759 852627

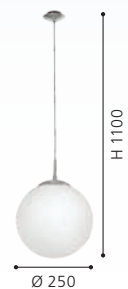



**85263**



**91589**



**85264**



### 85263 RONDO

pendant light; steel, satin nickel / glass opal-matt, white  
Hängeleuchte; Stahl, nickel-matt / Glas opal-matt, weiss  
luminaire en suspension; acier, nickel mat / verre opale mat, blanc

H 1100, Ø 300



E27 1x 60W



### 91589 RONDO

ceiling light; steel, satin nickel / glass opal-matt, white  
Deckenleuchte; Stahl, nickel-matt / Glas opal-matt, weiss  
plafonnier; acier, nickel mat / verre opale mat, blanc

H 315, Ø 250



E27 1x 60W



### 85264 RONDO

table light; plastic, white / glass opal-matt, white  
Tischleuchte; Kunststoff, weiss / Glas opal-matt, weiss  
luminaire de table; plastique, blanc / verre opale mat, blanc

H 200, Ø 200

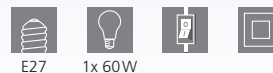

E27 1x 60W

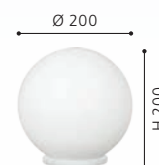



**900395**

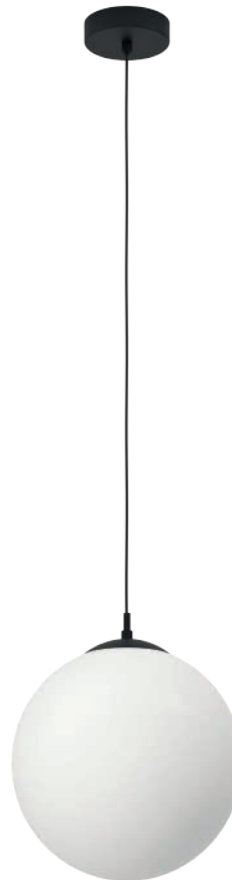

**900511**



**900512**

The flower pots are included with this luminaire.

Die Blumentöpfe sind bei dieser Leuchte inkludiert.

Les pots de fleurs sont inclus avec ce luminaire.

**900395 RONDO**

pendant light; steel, satin nickel / glass opal-matt, white  
 Hängeleuchte; Stahl, nickel-matt / Glas opal-matt, weiss  
 luminaire en suspension; acier, nickel mat / verre opale mat, blanc

L 960, B 200, H 1100



E27

3x 40W

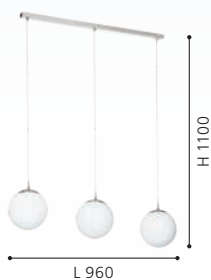

**900511 RONDO 3**

pendant light; steel, black / glass opal-matt, white  
 Hängeleuchte; Stahl, schwarz / Glas opal-matt, weiss  
 luminaire en suspension; acier, noir / verre opale mat, blanc

H 1100, Ø 300



E27

1x 40W



**900512 RONDO 3**

pendant light; steel, black / glass opal-matt, white  
 Hängeleuchte; Stahl, schwarz / Glas opal-matt, weiss  
 luminaire en suspension; acier, noir / verre opale mat, blanc

L 1210, B 200, H 1100



E27

3x 40W

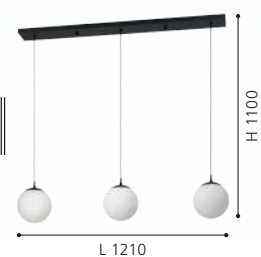





900512



**86811**



**86812**



OPTICA



**86816**

### 86811 OPTICA

wall / ceiling light; steel, satin nickel / glass opal-matt, white  
Wand- / Deckenleuchte; Stahl, nickel-matt / Glas opal-matt, weiss  
applique / plafonnier; acier, nickel mat / verre opale mat, blanc

H 160, Ø 280



E27

2x 60W

### 86812 OPTICA

wall / ceiling light; steel, satin nickel / glass opal-matt, white  
Wand- / Deckenleuchte; Stahl, nickel-matt / Glas opal-matt, weiss  
applique / plafonnier; acier, nickel mat / verre opale mat, blanc

H 210, Ø 350



E27

2x 60W

### 86816 OPTICA

table light; steel, satin nickel / glass opal-matt, white  
Tischleuchte; Stahl, nickel-matt / Glas opal-matt, weiss  
luminaire de table; acier, nickel mat / verre opale mat, blanc

H 460, Ø 280, Base: Ø 195



E27

2x 60W



9 002759 868116

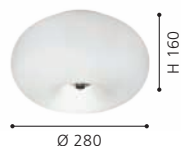

9 002759 868123

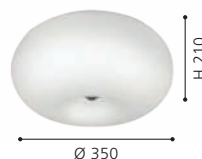

9 002759 868161



### 86817 OPTICA

floor light; steel, satin nickel / glass opal-matt, white  
Stehleuchte; Stahl, nickel-matt / Glas opal-matt, weiss  
lampadaire; acier, nickel mat / verre opale mat, blanc

H 1570, Ø 350



E27



2x 60W



9 002759 868178

Ø 350

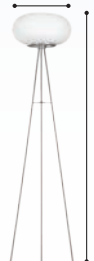

H 1570



86817

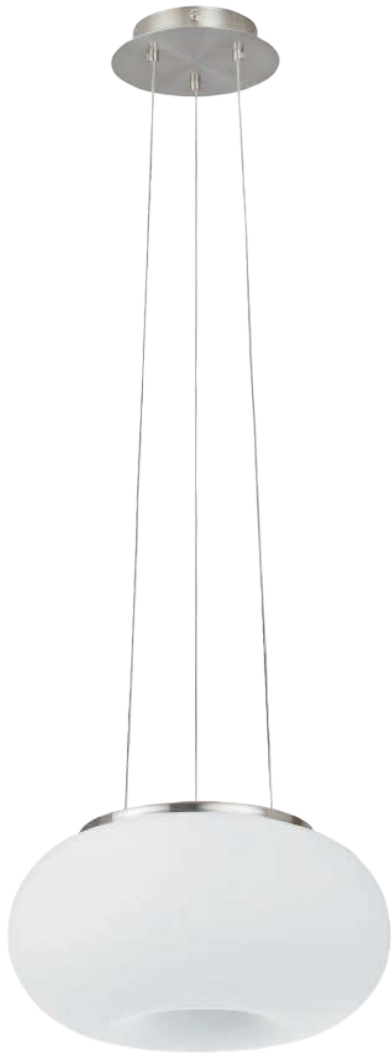

**86813**



**86814**



**86813 OPTICA**

pendant light; steel, satin nickel / glass opal-matt, white  
 Hängeleuchte; Stahl, nickel-matt / Glas opal-matt, weiss  
 luminaire en suspension; acier, nickel mat / verre opale mat, blanc

H 1100, Ø 280



**86814 OPTICA**

pendant light; steel, satin nickel / glass opal-matt, white  
 Hängeleuchte; Stahl, nickel-matt / Glas opal-matt, weiss  
 luminaire en suspension; acier, nickel mat / verre opale mat, blanc

H 1100, Ø 350



**86815 OPTICA**

pendant light; steel, satin nickel / glass opal-matt, white  
 Hängeleuchte; Stahl, nickel-matt / Glas opal-matt, weiss  
 luminaire en suspension; acier, nickel mat / verre opale mat, blanc

H 1100, Ø 445

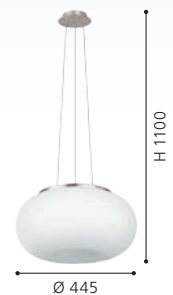





86815



99631



99632



DESIGN  
HIGHLIGHT  
DETAIL



33984

### 99631 GOROSIBA 1

ceiling light; steel, black / glass vaporized, black-transparent  
Deckenleuchte; Stahl, schwarz / Glas bedampft, schwarz-transparent  
plafonnier; acier, noir / verre vaporisé, noir transparent

H 175, Ø 450



E27 3x 40W

### 99632 GOROSIBA 1

ceiling light; steel, black / glass vaporized, black-transparent  
Deckenleuchte; Stahl, schwarz / Glas bedampft, schwarz-transparent  
plafonnier; acier, noir / verre vaporisé, noir transparent

L 380, B 380, H 170



E27 4x 40W

### 33984 GOROSIBA

table light; steel, black / glass vaporized, black-transparent  
Tischleuchte; Stahl, schwarz / Glas bedampft, schwarz-transparent  
luminaire de table; acier, noir / verre vaporisé, noir transparent

H 220, Ø 150, Base: Ø 100

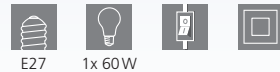

E27 1x 60W



9 002759 996314



9 002759 996321



9 002759 339845





### 98752 GOROSIBA

pendant light; steel, black / glass vaporized, black-transparent  
 Hängeleuchte; Stahl, schwarz / Glas bedampft, schwarz-transparent  
 luminaire en suspension; acier, noir / verre vaporisé, noir transparent

H 1100, Ø 150

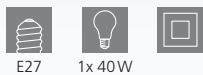

### 98753 GOROSIBA

pendant light; steel, black / glass vaporized, black-transparent  
 Hängeleuchte; Stahl, schwarz / Glas bedampft, schwarz-transparent  
 luminaire en suspension; acier, noir / verre vaporisé, noir transparent

L 850, B 150, H 1100



### 98754 GOROSIBA

pendant light; steel, black / glass vaporized, black-transparent  
 Hängeleuchte; Stahl, schwarz / Glas bedampft, schwarz-transparent  
 luminaire en suspension; acier, noir / verre vaporisé, noir transparent

H 1300, Ø 410

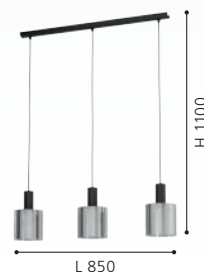

DESIGN  
HIGHLIGHT  
DETAIL



**900341**

### 900341 PINTO TEXTIL 1

pendant light; steel, black / glass, fabric, clear, black  
Hängeleuchte; Stahl, schwarz / Glas, Textil, klar, schwarz  
luminaire en suspension; acier, noir / verre, tissu, transparent, noir

H 1100, Ø 120



### 900342 PINTO TEXTIL 1

pendant light; steel, black / glass, fabric, clear, black  
Hängeleuchte; Stahl, schwarz / Glas, Textil, klar, schwarz  
luminaire en suspension; acier, noir / verre, tissu, transparent, noir

L 820, B 120, H 1100







900342



99288



99288



99286

### 99288 PINTO TEXTIL

wall light; steel, satin nickel / glass, fabric, clear, grey  
 Wandleuchte; Stahl, nickel-matt / Glas, Textil, klar, grau  
 applique; acier, nickel mat / verre, tissu, transparent, gris

L 120, H 445, A 180



E27 1x 16W



9 002759 992880



### 99286 PINTO TEXTIL

pendant light; steel, satin nickel / glass, fabric, clear, grey  
 Hängeleuchte; Stahl, nickel-matt / Glas, Textil, klar, grau  
 luminaire en suspension; acier, nickel mat / verre, tissu, transparent, gris

L 820, B 120, H 1100



E27 3x 16W



9 002759 992866





99286 | 99287



**99287**

### 99287 PINTO TEXTIL

pendant light; steel, satin nickel / glass, fabric, clear, grey  
 Hängeleuchte; Stahl, nickel-matt / Glas, Textil, klar, grau  
 luminaire en suspension; acier, nickel mat / verre, tissu, transparent, gris

L 945, B 120, H 1100



9 002759 992873





**90304**



PINTO NERO

### 90304 PINTO NERO

pendant light; steel, satin nickel / smoked glass, glass opal-matt, black-transparent, white

Hängeleuchte; Stahl, nickel-matt / Rauchglas, Glas opal-matt, schwarz-transparent, weiss

luminaire en suspension; acier, nickel mat / verre fumé, verre opale mat, noir transparent, blanc

H 1100, Ø 110



E27



1x 40W



9 002759 903046



### 90305 PINTO NERO

pendant light; steel, satin nickel / smoked glass, glass opal-matt, black-transparent, white

Hängeleuchte; Stahl, nickel-matt / Rauchglas, Glas opal-matt, schwarz-transparent, weiss

luminaire en suspension; acier, nickel mat / verre fumé, verre opale mat, noir transparent, blanc

L 725, H 1100



E27



3x 40W



9 002759 903053

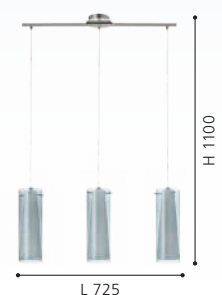





90305



97653



97839

97651

### 97653 PINTO GOLD

pendant light; steel, black / glass, clear, gold  
 Hängeleuchte; Stahl, schwarz / Glas, klar, gold  
 luminaire en suspension; acier, noir / verre, transparent, or

L 905, B 360, H 1100



E27

4x 40W



9 002759 976538

### 97651 PINTO GOLD

pendant light; steel, black / glass, clear, gold  
 Hängeleuchte; Stahl, schwarz / Glas, klar, gold  
 luminaire en suspension; acier, noir / verre, transparent, or

H 1100, Ø 110



E27

1x 40W

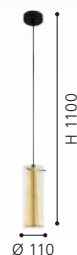

9 002759 976514

### 97839 PINTO GOLD

wall light; steel, black / glass, clear, gold  
 Wandleuchte; Stahl, schwarz / Glas, klar, gold  
 applique; acier, noir / verre, transparent, or

L 110, H 270, A 150



E27

1x 40W



9 002759 978396



**97652**



**97655**



PINTO GOLD



DESIGN  
HIGHLIGHT  
DETAIL



**97652 PINTO GOLD**

pendant light; steel, black / glass, clear, gold  
Hängeleuchte; Stahl, schwarz / Glas, klar, gold  
luminaire en suspension; acier, noir / verre, transparent, or

L 725, B 110, H 1100



E27 3x 40W

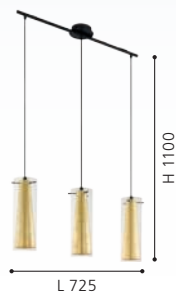

9 002759 976521

**97655 PINTO GOLD**

floor light; steel, black, gold / glass, clear, gold  
Stehleuchte; Stahl, schwarz, gold / Glas, klar, gold  
lampadaire; acier, noir, or / verre, transparent, or

H 1470, Ø 110, Base: Ø 230

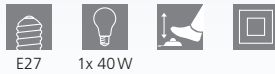

E27 1x 40W



9 002759 976552

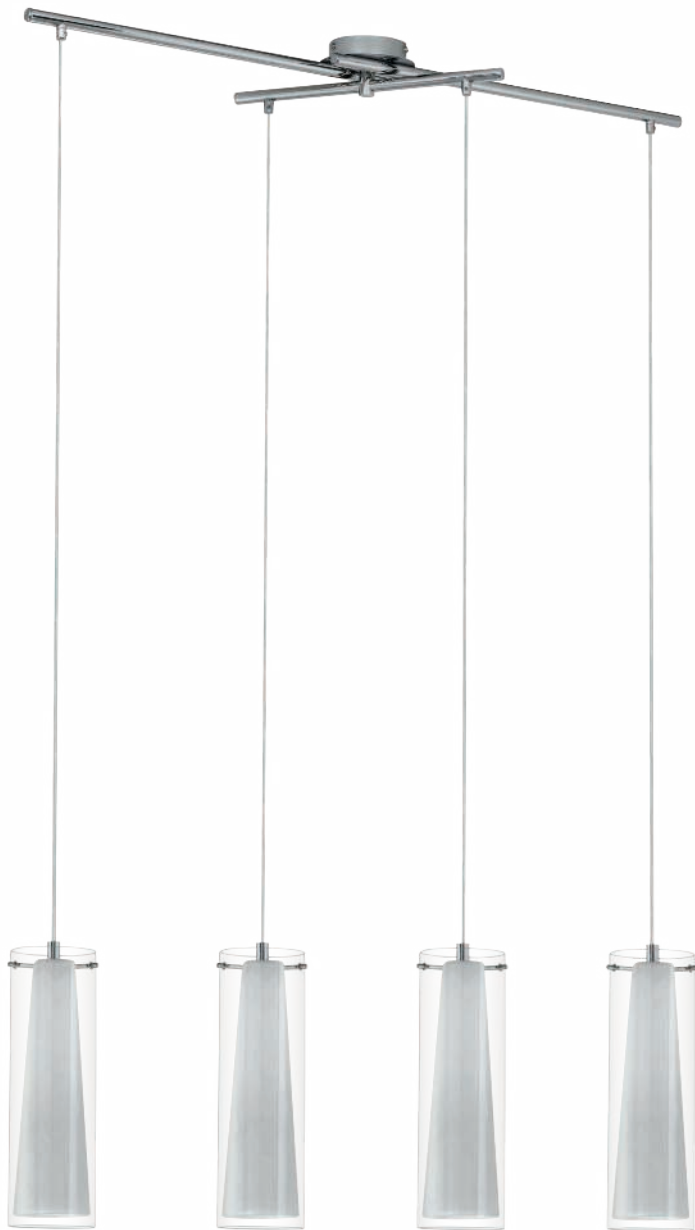

**89834**



89832 | 89833 | 89834 |  
89835 | 89836



**89832**



**89835**

### 89834 PINTO

pendant light; steel, chrome / glass, glass opal-matt, clear, white  
Hängeleuchte; Stahl, chrom / Glas, Glas opal-matt, klar, weiss  
luminaire en suspension; acier, chrome / verre, verre opale mat,  
transparent, blanc

L 905, B 360, H 1100



E27 4x 40W



9 002759 898342

### 89835 PINTO

table light; steel, chrome / glass, glass opal-matt, clear, white  
Tischleuchte; Stahl, chrom / Glas, Glas opal-matt, klar, weiss  
luminaire de table; acier, chrome / verre, verre opale mat,  
transparent, blanc

H 500, Ø 110, Base: Ø 155



E27 1x 40W



9 002759 898359

### 89832 PINTO

pendant light; steel, chrome / glass, glass opal-matt, clear, white  
Hängeleuchte; Stahl, chrom / Glas, Glas opal-matt, klar, weiss  
luminaire en suspension; acier, chrome / verre, verre opale mat,  
transparent, blanc

H 1100, Ø 110



E27 1x 40W

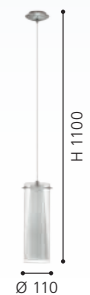

9 002759 898328





**93003**



**89833**



**89836**

### 93003 PINTO

pendant light; steel, chrome / glass, glass opal-matt, clear, white  
Hängeleuchte; Stahl, chrom / Glas, Glas opal-matt, klar, weiss  
luminaire en suspension; acier, chrome / verre, verre opale mat, transparent, blanc

H 1500, Ø 500



E27 5x 40W



9 002759 930035

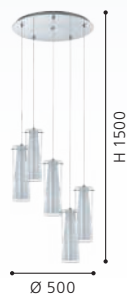

### 89833 PINTO

pendant light; steel, chrome / glass, glass opal-matt, clear, white  
Hängeleuchte; Stahl, chrom / Glas, Glas opal-matt, klar, weiss  
luminaire en suspension; acier, chrome / verre, verre opale mat, transparent, blanc

L 725, H 1100



E27 3x 40W



9 002759 898335



### 89836 PINTO

floor light; steel, chrome / glass, glass opal-matt, clear, white  
Stehleuchte; Stahl, chrom / Glas, Glas opal-matt, klar, weiss  
lampadaire; acier, chrome / verre, verre opale mat, transparent, blanc

H 1470, Ø 110, Base: Ø 230



E27 1x 40W



9 002759 898366





**85978**



**85977**

### 85978 TROY 3

pendant light; steel, satin nickel / satin glass, white painted  
 Hängeleuchte; Stahl, nickel-matt / Glas satiniert, weiss lackiert  
 luminaire en suspension; acier, nickel mat / verre satiné, blanc laqué

L 720, B 105, H 1100



E27



3x 40W



9 002759 859787



### 85977 TROY 3

pendant light; steel, satin nickel / satin glass, white painted  
 Hängeleuchte; Stahl, nickel-matt / Glas satiniert, weiss lackiert  
 luminaire en suspension; acier, nickel mat / verre satiné, blanc laqué

H 1100, Ø 110



E27



1x 40W



9 002759 859770



### 85979 TROY 3

wall light; steel, satin nickel / satin glass, white  
 Wandleuchte; Stahl, nickel-matt / Glas satiniert, weiss  
 applique; acier, nickel mat / verre satiné, blanc laqué

L 180, H 250, A 75



E14



1x 60W



9 002759 859794





**85979**



85979



**85981**



85977 | 85978 | 85981 |  
85982

### 85981 TROY 3

table light; steel, satin nickel / satin glass, white painted  
Tischleuchte; Stahl, nickel-matt / Glas satiniert, weiss lackiert  
luminaire de table; acier, nickel mat / verre satiné, blanc laqué

H 460, Ø 105, Base: Ø 120



E27 1x 40W



9 002759 859817



### 85982 TROY 3

floor light; steel, satin nickel / satin glass, white painted  
Stehleuchte; Stahl, nickel-matt / Glas satiniert, weiss lackiert  
lampadaire; acier, nickel mat / verre satiné, blanc laqué

H 1530, Ø 105, Base: Ø 200



E27 1x 40W



9 002759 859824



**85982**



92739



92739 | 92741 | 92743

### 92739 RIVATO

pendant light; steel, chrome / glass with decor, white, chrome  
Hängeleuchte; Stahl, chrom / Glas mit Dekor, weiss, chrom  
luminaire en suspension; acier, chrome / verre avec décor, blanc, chrome

H 1100, Ø 90



E27



1x 60W



9 002759 927394







92741



92742



92743



92742

### 92741 RIVATO

pendant light; steel, chrome / glass with decor, white, chrome  
 Hängeleuchte; Stahl, chrom / Glas mit Dekor, weiss, chrom  
 luminaire en suspension; acier, chrome / verre avec décor, blanc, chrome

L 705, B 90, H 1100



E27 3x 60W



9 002759 927417



L 705

H 1100

### 92742 RIVATO

wall light; steel, white, chrome / glass with decor, white, chrome  
 Wandleuchte; Stahl, weiss, chrom / Glas mit Dekor, weiss, chrom  
 applique; acier, blanc, chrome / verre avec décor, blanc, chrome

L 180, H 250, A 80



E14 1x 42W



9 002759 927424



L 180

H 250

### 92743 RIVATO

table light; glass, plastic, white, chrome  
 Tischleuchte; Glas, Kunststoff, weiss, chrom  
 luminaire de table; verre, plastique, blanc, chrome

H 260, Ø 90

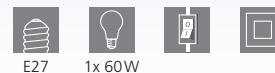

E27 1x 60W



9 002759 927431



Ø 90

H 260



**90048**



**90049**



EGLO  
RECOMMENDS  
**110043**

90049

### 90048 AMADORA

pendant light; steel, satin nickel / glass printed, white  
Hängeleuchte; Stahl, nickel-matt / Glas bedruckt, weiss  
luminaire en suspension; acier, nickel mat / verre imprimé, blanc

L 720, B 105, H 1100



E27



3x 60W



9 002759 900489



### 90049 AMADORA

wall light; steel, satin nickel / glass printed, white  
Wandleuchte; Stahl, nickel-matt / Glas bedruckt, weiss  
applique; acier, nickel mat / verre imprimé, blanc

L 180, H 250, A 75



E14



1x 60W



9 002759 900496





**92563**



90048 | 91971 | 92563



**91971**

### 92563 BAYMAN

pendant light; steel, chrome / glass, white, chrome  
 Hängeleuchte; Stahl, chrom / Glas, weiss, chrom  
 luminaire en suspension; acier, chrome / verre, blanc, chrome

L 720, B 105, H 1100

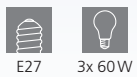

### 91971 BAYMAN

table light; glass, plastic, white, chrome  
 Tischleuchte; Glas, Kunststoff, weiss, chrom  
 luminaire de table; verre, plastique, blanc, chrome

H 270, Ø 105

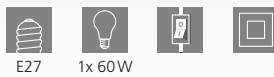



91433



91002



91004

### 91433 VINOVO

pendant light; steel, dark brown / glass alabaster, white  
 Hängeleuchte; Stahl, dunkelbraun / Glas alabaster, weiss  
 luminaire en suspension; acier, marron foncé / verre albâtre, blanc

L 770, B 250, H 1100



E27



2x 60W



9 002759 914332



### 91002 MURCIA

pendant light; steel, black / glass alabaster, white  
 Hängeleuchte; Stahl, schwarz / Glas alabaster, weiss  
 luminaire en suspension; acier, noir / verre albâtre, blanc

H 1100, Ø 380



E27



1x 60W



9 002759 910020



### 91004 MURCIA

pendant light; steel, black / glass alabaster, white  
 Hängeleuchte; Stahl, schwarz / Glas alabaster, weiss  
 luminaire en suspension; acier, noir / verre albâtre, blanc

L 680, H 1100



E27



2x 60W



9 002759 910044







### MURCIA, VINOVO

These luminaires come with high quality processed alabaster glass.

Diese Leuchten sind mit hochwertigem Alabasterglas ausgestattet.

Ces luminaires viennent avec un abat-jour en verre d'albâtre haut de gamme.

#### 91005 MURCIA

pendant light; steel, black / glass alabaster, white  
 Hängeleuchte; Stahl, schwarz / Glas alabaster, weiss  
 luminaire en suspension; acier, noir / verre albâtre, blanc

H 1100, Ø 630

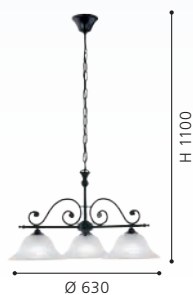

#### 91006 MURCIA

wall light; steel, black / glass alabaster, white  
 Wandleuchte; Stahl, schwarz / Glas alabaster, weiss  
 applique; acier, noir / verre albâtre, blanc

L 165, H 190, A 230

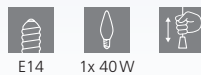



82748



82749



DESIGN  
HIGHLIGHT  
DETAIL

### 82748 SAVOY

pendant light; cast metal, bronzed / satin glass, white  
Hängeleuchte; Metallguss, brüniert / Glas satiniert, weiss  
luminaire en suspension; fonte métallique, brun / verre satiné, blanc

H 1100, Ø 740



### 82749 SAVOY

pendant light; cast metal, bronzed / satin glass, white  
Hängeleuchte; Metallguss, brüniert / Glas satiniert, weiss  
luminaire en suspension; fonte métallique, brun / verre satiné, blanc

H 1100, Ø 740





82751



82752



82747



### 82751 SAVOY

wall light; cast metal, bronzed / satin glass, white  
Wandleuchte; Metallguss, brüniert / Glas satiniert, weiss  
applique; fonte métallique, brun / verre satiné, blanc

L 180, H 160, A 240



E14 1x 40W



9 002759 827519



### 82752 SAVOY

wall light; cast metal, bronzed / satin glass, white  
Wandleuchte; Metallguss, brüniert / Glas satiniert, weiss  
applique; fonte métallique, brun / verre satiné, blanc

L 410, H 160, A 210



E14 2x 40W



9 002759 827526



### 82747 SAVOY

pendant light; cast metal, bronzed / satin glass, white  
Hängeleuchte; Metallguss, brüniert / Glas satiniert, weiss  
luminaire en suspension; fonte métallique, brun / verre satiné, blanc

H 1100, Ø 310



E27 2x 60W



9 002759 827472

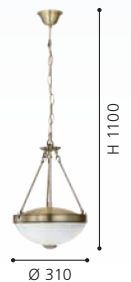



**85856**



**85857**



**85859**

### 85856 MARBELLA

ceiling light; cast metal, bronzed / glass alabaster, champagne  
Deckenleuchte; Metallguss, brüniert / Glas alabaster, champagner  
plafonnier; fonte métallique, brun / verre albâtre, champagne

H 410, Ø 370



E14 3x 60W



9 002759 858568

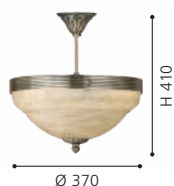

### 85857 MARBELLA

pendant light; cast metal, bronzed / glass alabaster, champagne  
Hängeleuchte; Metallguss, brüniert / Glas alabaster, champagner  
luminaire en suspension; fonte métallique, brun / verre albâtre, champagne

H 1100, Ø 740



E14 6x 60W



9 002759 858575



### 85859 MARBELLA

wall light; cast metal, bronzed / glass alabaster, champagne  
Wandleuchte; Metallguss, brüniert / Glas alabaster, champagner  
applique; fonte métallique, brun / verre albâtre, champagne

L 170, H 200, A 230



E14 1x 40W



9 002759 858599







85858

### 85858 MARBELLA

pendant light; cast metal, bronzed / glass alabaster, champagne  
 Hängeleuchte; Metallguss, brüniert / Glas alabaster, champagner  
 luminaire en suspension; fonte métallique, brun / verre albâtre, champagne

H 1100, Ø 740



### MARBELLA

These luminaires come with high quality processed alabaster glass.

Diese Leuchten sind mit hochwertigem Alabasterglas ausgestattet.

Ces luminaires viennent avec un abat-jour en verre d'albâtre haut de gamme.



### 98876 ERVIDEL

pendant light; steel, black / plastic, satined, clear  
 Hängeleuchte; Stahl, schwarz / Kunststoff, satiniert, klar  
 luminaire en suspension; acier, noir / plastique, satiné, transparent

L 930, B 60, H 1100



6x 4,5W 2880lm



9 002759 988760

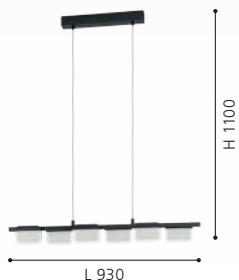

### 98874 ERVIDEL

ceiling light; steel, black / plastic, satined, clear  
 Deckenleuchte; Stahl, schwarz / Kunststoff, satiniert, klar  
 plafonnier; acier, noir / plastique, satiné, transparent

L 625, B 60, H 160



4x 4,5W 1920lm



9 002759 988746



### 98875 ERVIDEL

ceiling light; steel, black / plastic, satined, clear  
 Deckenleuchte; Stahl, schwarz / Kunststoff, satiniert, klar  
 plafonnier; acier, noir / plastique, satiné, transparent

L 930, B 60, H 160



6x 4,5W 2880lm



9 002759 988753







98878

LED



98877

LED

### 98878 ERVIDEL

table light; steel, black / plastic, satined, clear  
Tischleuchte; Stahl, schwarz / Kunststoff, satiniert, klar  
luminaire de table; acier, noir / plastique, satiné, transparent

L 155, B 60, H 500, Base: B 180, T 180



2x 4,5W 960lm



9 002759 988784



### 98877 ERVIDEL

wall light; steel, black / plastic, satined, clear  
Wandleuchte; Stahl, schwarz / Kunststoff, satiniert, klar  
applique; acier, noir / plastique, satiné, transparent

L 320, H 90, A 80

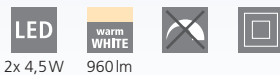

2x 4,5W 960lm



9 002759 988777





900351

LED



900352

LED



### 900351 CLAVELLINA

ceiling light; steel, black / plastic, white  
Deckenleuchte; Stahl, schwarz / Kunststoff, weiss  
plafonnier; acier, noir / plastique, blanc

L 890, B 465, H 185

LED

warm  
WHITE



4x 6,8W 3200lm

### 900352 CLAVELLINA

pendant light; steel, black / plastic, white  
Hängeleuchte; Stahl, schwarz / Kunststoff, weiss  
luminaire en suspension; acier, noir / plastique, blanc

L 1200, B 400, H 1100

LED

warm  
WHITE



6x 7W 4800lm

### 900353 CLAVELLINA

table light; steel, black / plastic, white  
Tischleuchte; Stahl, schwarz / Kunststoff, weiss  
luminaire de table; acier, noir / plastique, blanc

L 550, H 450, Base: Ø 180

LED

warm  
WHITE



1x 6,8W 800lm



9 008606 241088



9 008606 241095

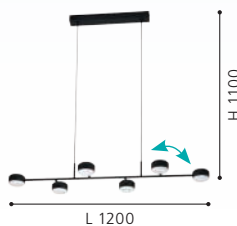

9 008606 241101







900353



**900354 CLAVELLINA**

floor light; steel, black / plastic, white  
 Stehleuchte; Stahl, schwarz / Kunststoff, weiss  
 lampadaire; acier, noir / plastique, blanc

L 1215, H 1605, Base: Ø 300



24W



2210lm

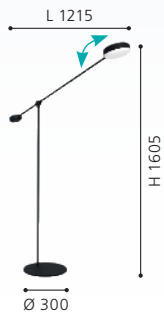

9 008606 243518



900354





99562

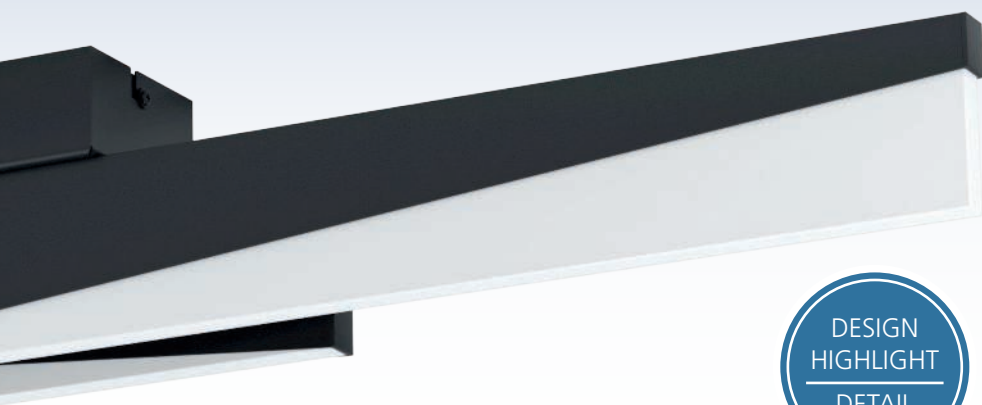

DESIGN  
HIGHLIGHT  
DETAIL

**99562 ISIDRO**

pendant light; aluminium, steel, black / plastic, satined  
 Hängeleuchte; Alu, Stahl, schwarz / Kunststoff, satiniert  
 luminaire en suspension; aluminium, acier, noir / plastique,  
 satiné

L 795, B 60, H 1100

LED  
27W

warm  
WHITE  
3850lm



9 002759 995621

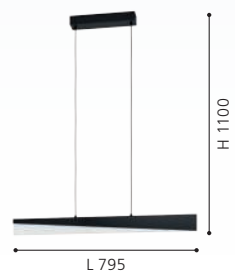



99561



99563



99564



### 99561 ISIDRO

ceiling light; aluminium, steel, black / plastic, satined  
Deckenleuchte; Alu, Stahl, schwarz / Kunststoff, satiniert  
plafonnier; aluminium, acier, noir / plastique, satiné

L 860, B 80, H 110



2x 11W 2700lm



9 002759 995614

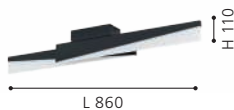

### 99563 ISIDRO

wall light; aluminium, steel, black / plastic, satined  
Wandleuchte; Alu, Stahl, schwarz / Kunststoff, satiniert  
applique; aluminium, acier, noir / plastique, satiné

L 395, H 80, A 70



9W 1050lm



9 002759 995638

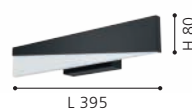

### 99564 ISIDRO

table light; aluminium, steel, black / plastic, satined  
Tischleuchte; Alu, Stahl, schwarz / Kunststoff, satiniert  
luminaire de table; aluminium, acier, noir / plastique, satiné

L 70, B 15, H 410, Base: B 150, T 130



9W 1050lm



9 002759 995645

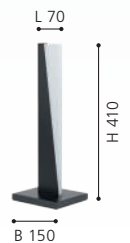





900563

LED



### CARANACOA

These luminaires have swiveling light rings.

Diese Leuchten verfügen über schwenkbare Leuchtringe.

Ces luminaires ont des anneaux lumineux pivotants.

### 900563 CARANACOA

pendant light; steel, black / plastic, white  
 Hängeleuchte; Stahl, schwarz / Kunststoff, weiss  
 luminaire en suspension; acier, noir / plastique, blanc

L 1170, B 230, H 1100

LED

5x 7W

warm  
 WHITE

7000lm

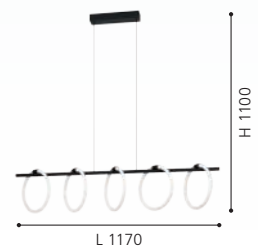





900562

LED



900564

LED



900565

LED

### 900562 CARANACOA

pendant light; steel, black / plastic, white  
Hängeleuchte; Stahl, schwarz / Kunststoff, weiss  
luminaire en suspension; acier, noir / plastique, blanc

L 780, B 230, H 1100



3x 9W 3600lm



9 008606 244645

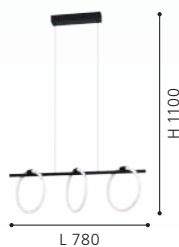

### 900564 CARANACOA

wall light; steel, black / plastic, white  
Wandleuchte; Stahl, schwarz / Kunststoff, weiss  
applique; acier, noir / plastique, blanc

L 260, H 260, A 45



11,5W 1500lm



9 008606 244669



### 900565 CARANACOA

table light; steel, black / plastic, white  
Tischleuchte; Stahl, schwarz / Kunststoff, weiss  
luminaire de table; acier, noir / plastique, blanc

L 260, B 50, H 260, Base: Ø 100



11,5W 1500lm



9 008606 244676

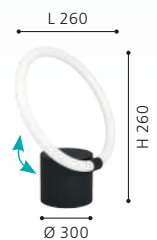



39836

LED



99429

LED

### 39836 BANDERILLAS

ceiling light; steel, black / plastic, white, black  
Deckenleuchte; Stahl, schwarz / Kunststoff, weiss, schwarz  
plafonnier; acier, noir / plastique, blanc, noir

L 1160, B 170, H 200



2x 12W  
2x  
1950lm



9 002759 398361



### 99429 ALAMEDILLA

pendant light; steel, black / plastic, white, black  
Hängeleuchte; Stahl, schwarz / Kunststoff, weiss, schwarz  
luminaire en suspension; acier, noir / plastique, blanc, noir

L 970, B 380, H 1200



27W  
4200lm



9 002759 994297



### 39838 BANDERILLAS

table light; plastic, black / plastic, white  
Tischleuchte; Kunststoff, schwarz / Kunststoff, weiss  
luminaire de table; plastique, noir / plastique, blanc

H 300, Ø 195



10W  
1300lm



9 002759 398385





39838

LED

### 39839 BANDERILLAS

pendant light; steel, black / plastic, white, black  
 Hängeleuchte; Stahl, schwarz / Kunststoff, weiss, schwarz  
 luminaire en suspension; acier, noir / plastique, blanc, noir

H 1200, Ø 600

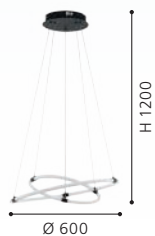

39839

LED



99358



900631



900632



### 99358 CODRIALES

pendant light; steel, black / plastic, white  
Hängeleuchte; Stahl, schwarz / Kunststoff, weiss  
luminaire en suspension; acier, noir / plastique, blanc

L 780, B 300, H 1100



27W



4000lm



9 002759 993580



### 900631 CODRIALES

ceiling light; aluminium, black / plastic, white  
Deckenleuchte; Alu, schwarz / Kunststoff, weiss  
plafonnier; aluminium, noir / plastique, blanc

L 790, B 300, H 116



27W



4000lm



9 008606 241040



### 900632 CODRIALES

wall light; aluminium, black / plastic, white  
Wandleuchte; Alu, schwarz / Kunststoff, weiss  
applique; aluminium, noir / plastique, blanc

L 180, H 320, A 65



10,8W



1400lm



9 008606 241057







900633



### 900633 CODRIALES

table light; aluminium, black / plastic, white

Tischleuchte; Alu, schwarz / Kunststoff, weiss

luminaire de table; aluminium, noir / plastique, blanc

L 205, B 80, H 380



10,8W



1500lm



9 008606 241064

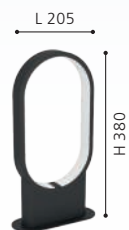



### 900465 SIBERIA

ceiling light; steel, black / plastic, white  
 Deckenleuchte; Stahl, schwarz / Kunststoff, weiss  
 plafonnier; acier, noir / plastique, blanc

L 780, B 160, H 235



34W 4600lm



### 900466 SIBERIA

pendant light; steel, black / plastic, white  
 Hängeleuchte; Stahl, schwarz / Kunststoff, weiss  
 luminaire en suspension; acier, noir / plastique, blanc

L 780, B 160, H 1100



34W 4500lm

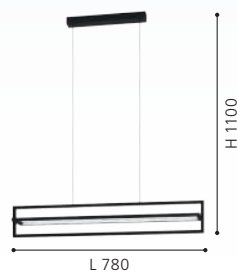

### 900467 SIBERIA

wall light; steel, black / plastic, white  
 Wandleuchte; Stahl, schwarz / Kunststoff, weiss  
 applique; acier, noir / plastique, blanc

L 160, H 300, A 190



15,5W 2200lm





900468

LED



incl./inkl./inclus



900469

LED

### 900468 SIBERIA

table light; steel, black / plastic, white  
Tischleuchte; Stahl, schwarz / Kunststoff, weiss  
luminaire de table; acier, noir / plastique, blanc

L 160, B 160, H 430, Base: B 160, T 160



15,5W 2200lm



9 008606 244072

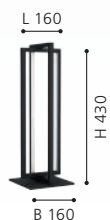

### 900469 SIBERIA

floor light; steel, black / plastic, white  
Stehleuchte; Stahl, schwarz / Kunststoff, weiss  
lampadaire; acier, noir / plastique, blanc

L 200, B 160, H 1330, Base: B 200, T 160



34W 4600lm



9 008606 244089

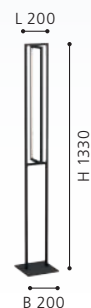



### 99799 LEJIAS

ceiling light; steel, black / plastic, transparent  
Deckenleuchte; Stahl, schwarz / Kunststoff, transparent  
plafonnier; acier, noir / plastique, transparent

L 450, B 450, H 75

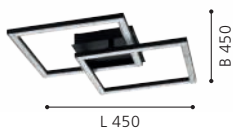

### 99801 LEJIAS

ceiling light; steel, black / plastic, transparent  
Deckenleuchte; Stahl, schwarz / Kunststoff, transparent  
plafonnier; acier, noir / plastique, transparent

L 780, B 80



### 99802 LEJIAS

pendant light; steel, black / plastic, transparent  
Hängeleuchte; Stahl, schwarz / Kunststoff, transparent  
luminaire en suspension; acier, noir / plastique, transparent

L 780, B 80, H 1750

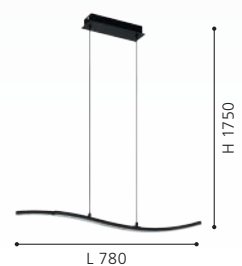





99803

LED



99804

LED



99805

LED

### 99803 LEJIAS

wall light; steel, black / plastic, transparent  
Wandleuchte; Stahl, schwarz / Kunststoff, transparent  
applique; acier, noir / plastique, transparent

L 90, H 285



8W 1050lm



9 002759 998035



### 99804 LEJIAS

table light; steel, black / plastic, transparent  
Tischleuchte; Stahl, schwarz / Kunststoff, transparent  
luminaire de table; acier, noir / plastique, transparent

H 330, Base: B 140, T 140



8W 900lm



9 002759 998042



### 99805 LEJIAS

floor light; steel, black / plastic, transparent  
Stehleuchte; Stahl, schwarz / Kunststoff, transparent  
lampadaire; acier, noir / plastique, transparent

H 1230, Base: B 230, T 230



16W 2050lm



9 002759 998059

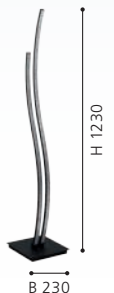

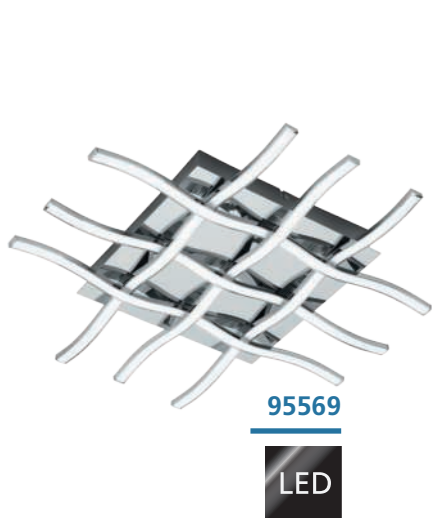

95569

LED

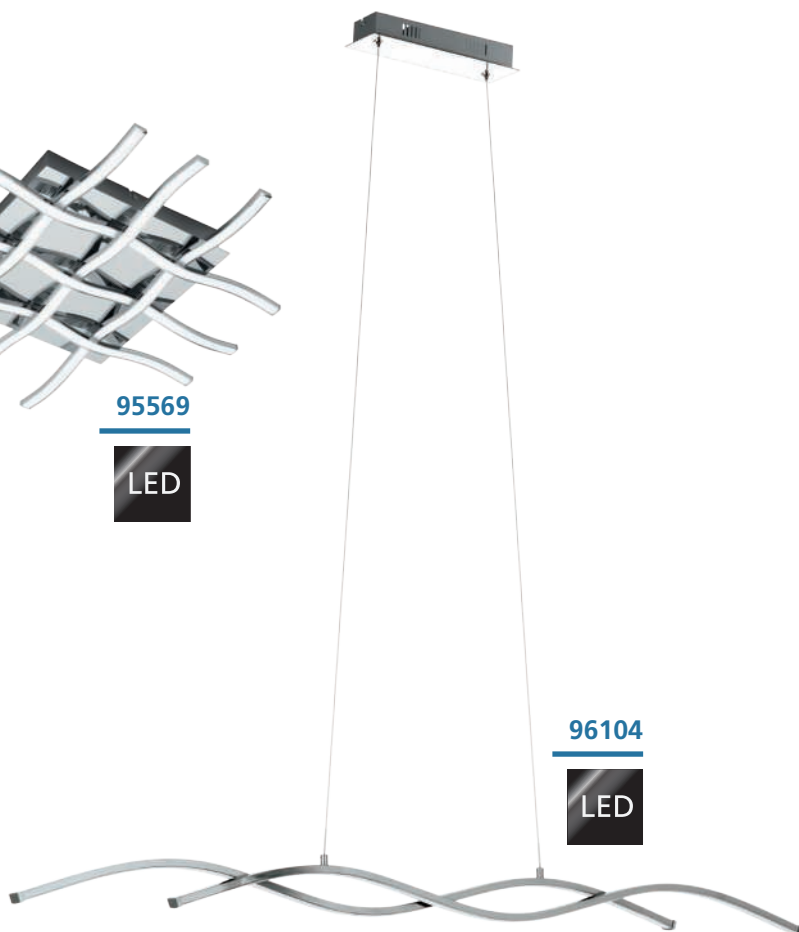

96104

LED

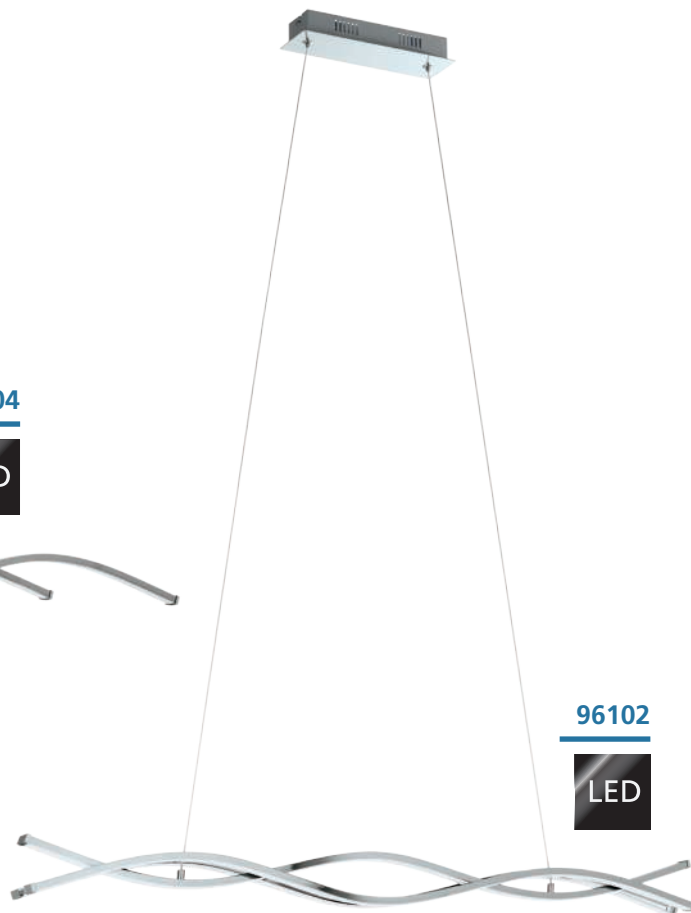

96102

LED

### 95569 LASANA 1

wall / ceiling light; steel, chrome / plastic, white  
Wand- / Deckenleuchte; Stahl, chrom / Kunststoff, weiss  
applique / plafonnier; acier, chrome / plastique, blanc

L 500, B 500, H 65

LED

warm  
WHITE



6x 6W

4860lm



9 002759 955694

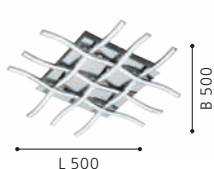

### 96104 LASANA 2

pendant light; steel, aluminium, chrome / plastic, white  
Hängeleuchte; Stahl, Alu, chrom / Kunststoff, weiss  
luminaire en suspension; acier, aluminium, chrome / plastique, blanc

L 1200, B 80, H 1200

LED

warm  
WHITE



24,5W

3300lm



9 002759 961046

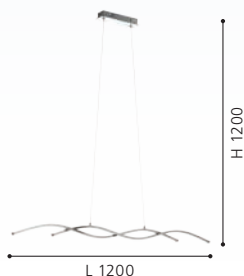

### 96102 LASANA 2

pendant light; steel, aluminium, chrome / plastic, white  
Hängeleuchte; Stahl, Alu, chrom / Kunststoff, weiss  
luminaire en suspension; acier, aluminium, chrome / plastique, blanc

L 1000, B 80, H 1200

LED

warm  
WHITE



35W

5300lm



9 002759 961022

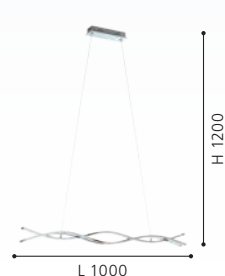

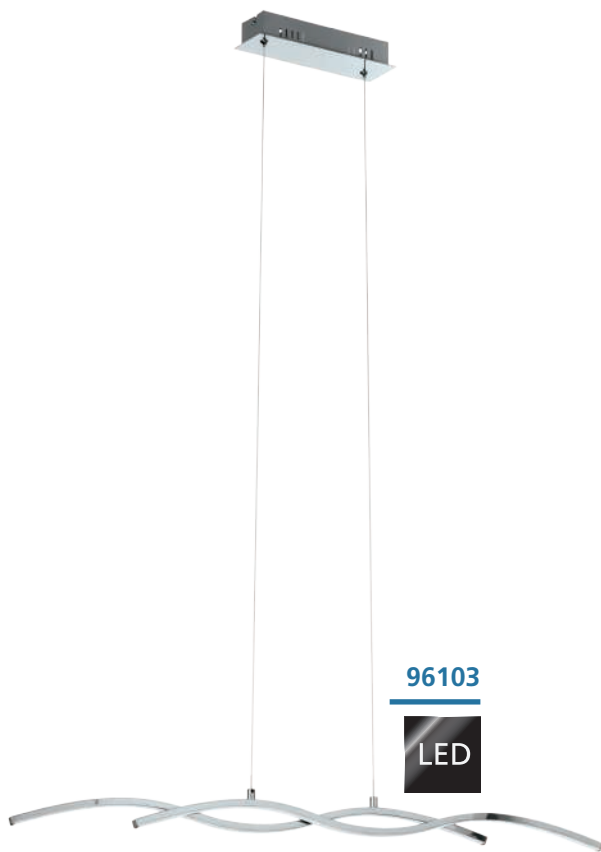

96103

LED



96105

LED



96106

LED

### 96103 LASANA 2

pendant light; steel, aluminium, chrome / plastic, white  
 Hängeleuchte; Stahl, Alu, chrom / Kunststoff, weiss  
 luminaire en suspension; acier, aluminium, chrome / plastique, blanc

L 870, B 80, H 1200



18W 2300lm



9 002759 961039

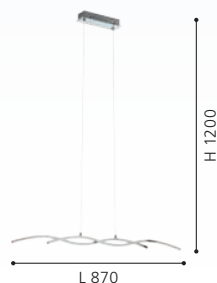

### 96105 LASANA 2

table light; steel, aluminium, chrome / plastic, white  
 Tischleuchte; Stahl, Alu, chrom / Kunststoff, weiss  
 luminaire de table; acier, aluminium, chrome / plastique, blanc

L 160, B 100, H 460



11,5W 1280lm



9 002759 961053



### 96106 LASANA 2

floor light; steel, aluminium, chrome / plastic, white  
 Stehleuchte; Stahl, Alu, chrom / Kunststoff, weiss  
 lampadaire; acier, aluminium, chrome / plastique, blanc

L 250, B 130, H 1420



36W 4700lm



9 002759 961060



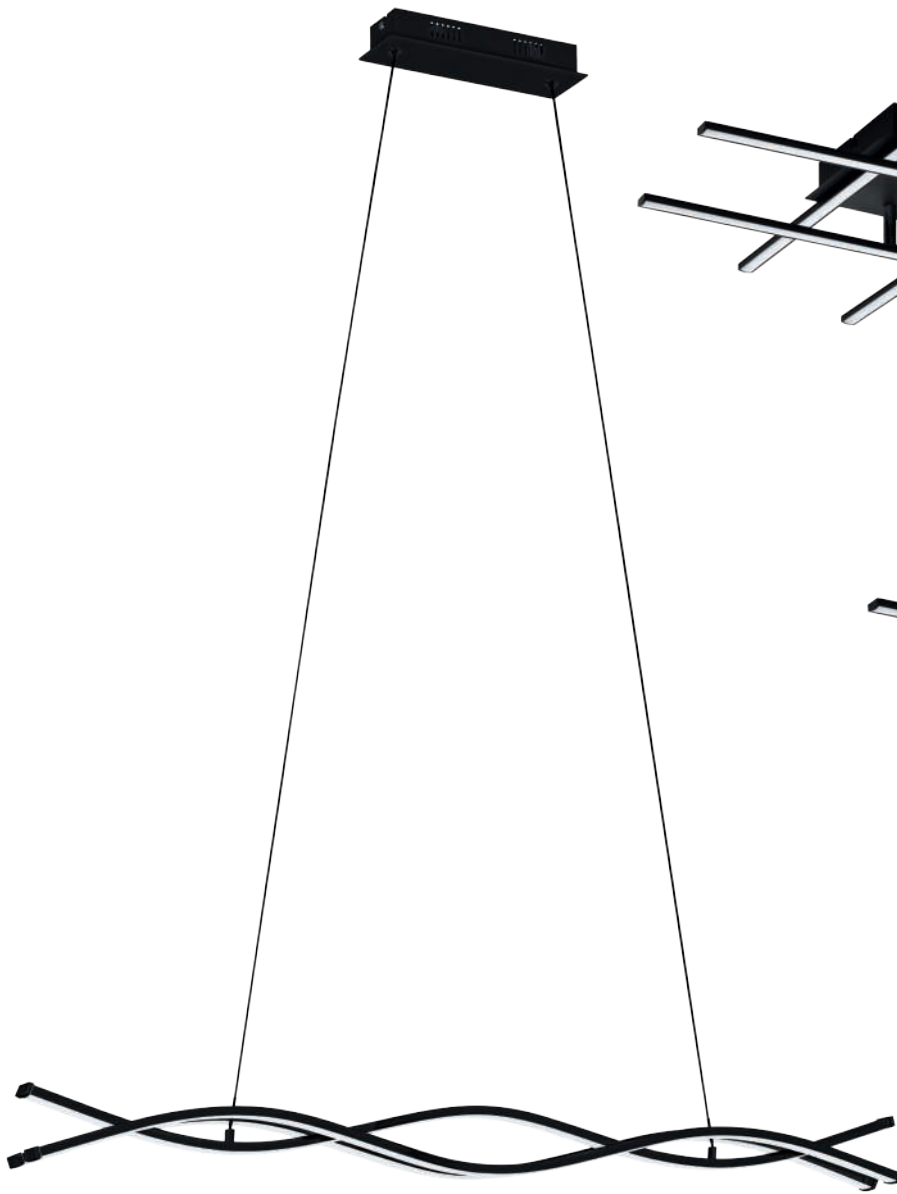

99317

LED

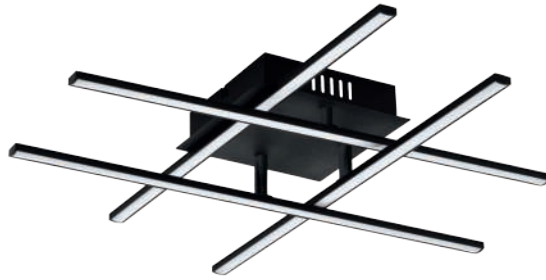

99316

LED



99315

LED

### 99317 LASANA 3

pendant light; steel, aluminium, black / plastic, white  
Hängeleuchte; Stahl, Alu, schwarz / Kunststoff, weiss  
luminaire en suspension; acier, aluminium, noir / plastique, blanc

L 985, B 80, H 1200

LED

warm  
WHITE  
4500lm



9 002759 993177

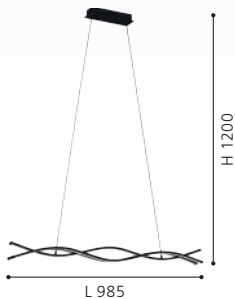

### 99316 LASANA 3

wall / ceiling light; steel, aluminium, black / plastic, white  
Wand- / Deckenleuchte; Stahl, Alu, schwarz / Kunststoff, weiss  
applique / plafonnier; acier, aluminium, noir / plastique, blanc

L 500, B 500, H 95

LED

warm  
WHITE  
2800lm



9 002759 993160

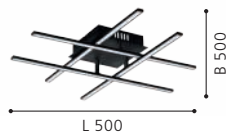

### 99315 LASANA 3

wall / ceiling light; steel, aluminium, black / plastic, white  
Wand- / Deckenleuchte; Stahl, Alu, schwarz / Kunststoff, weiss  
applique / plafonnier; acier, aluminium, noir / plastique, blanc

L 500, B 145, H 90

LED

warm  
WHITE  
1500lm



9 002759 993153

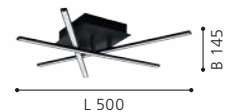





99319

LED



99318

LED

### 99319 LASANA 3

floor light; steel, aluminium, black / plastic, white  
 Stehleuchte; Stahl, Alu, schwarz / Kunststoff, weiss  
 lampadaire; acier, aluminium, noir / plastique, blanc

L 250, B 130, H 1420, Base: B 230, T 150



36W 4700lm



9 002759 993191



### 99318 LASANA 3

table light; steel, aluminium, black / plastic, white  
 Tischleuchte; Stahl, Alu, schwarz / Kunststoff, weiss  
 luminaire de table; acier, aluminium, noir / plastique, blanc

L 160, B 100, H 460, Base: B 180, T 100



11,5W 1280lm



9 002759 993184





95147

LED



32048

LED

### 95147 LASANA

pendant light; aluminium, steel, chrome / plastic, white  
 Hängeleuchte; Alu, Stahl, chrom / Kunststoff, weiss  
 luminaire en suspension; aluminium, acier, chrome / plastique, blanc

L 900, H 1100

LED

30W

warm  
WHITE

3500lm



9 002759 951474

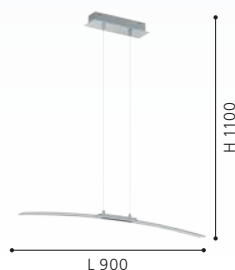

### 32048 LASANA

pendant light; aluminium, steel, chrome / plastic, white  
 Hängeleuchte; Alu, Stahl, chrom / Kunststoff, weiss  
 luminaire en suspension; aluminium, acier, chrome / plastique, blanc

L 900, H 1000

LED

15W

warm  
WHITE

1800lm



9 002759 320485

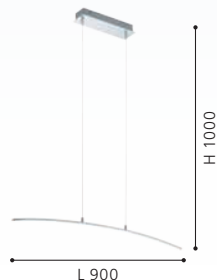

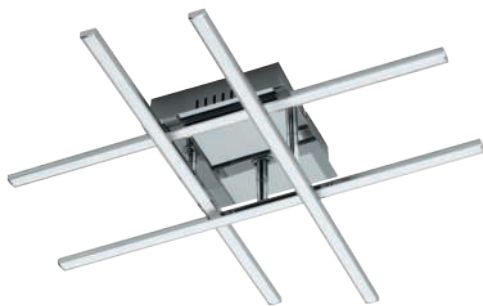

95568

LED



95567

LED



96866

LED

### 95568 LASANA 1

wall / ceiling light; steel, chrome / plastic, white  
Wand- / Deckenleuchte; Stahl, chrom / Kunststoff, weiss  
applique / plafonnier; acier, chrome / plastique, blanc

L 500, B 500, H 95



4x 5,3W 2800lm



9 002759 955687

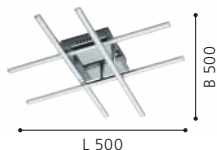

### 95567 LASANA 1

wall / ceiling light; steel, chrome / plastic, white  
Wand- / Deckenleuchte; Stahl, chrom / Kunststoff, weiss  
applique / plafonnier; acier, chrome / plastique, blanc

L 500, B 160, H 95



3x 3,5W 1500lm



9 002759 955670

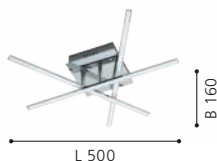

### 96866 TARANDELL

pendant light; aluminium, steel, chrome / plastic, satiné  
Hängeleuchte; Alu, Stahl, chrom / Kunststoff, satiniert  
luminaire en suspension; aluminium, acier, chrome / plastique, satiné

L 1180, B 60, H 930 - 1620



2x 12,5W 3300lm



9 002759 968663

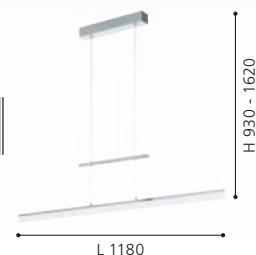



99322

LED



99321

LED



99323

LED

### 99322 RONCADE 1

wall / ceiling light; steel, aluminium, black / plastic, white  
Wand- / Deckenleuchte; Stahl, Alu, schwarz / Kunststoff, weiss  
applique / plafonnier; acier, aluminium, noir / plastique, blanc

L 1160, B 180, H 115



36W 4600lm



9 002759 993221

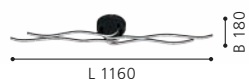

### 99321 RONCADE 1

wall / ceiling light; steel, aluminium, black / plastic, white  
Wand- / Deckenleuchte; Stahl, Alu, schwarz / Kunststoff, weiss  
applique / plafonnier; acier, aluminium, noir / plastique, blanc

L 650, B 130, H 45



21W 2800lm



9 002759 993214

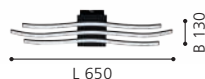

### 99323 SELVINA 1

ceiling light; steel, aluminium, black / plastic, white  
Deckenleuchte; Stahl, Alu, schwarz / Kunststoff, weiss  
plafonnier; acier, aluminium, noir / plastique, blanc

L 690, B 280, H 150



19W 2700lm



9 002759 993238







31996



31995



96329



### 31996 RONCADE

wall / ceiling light; aluminium, steel, chrome / plastic, white  
Wand- / Deckenleuchte; Alu, Stahl, chrom / Kunststoff, weiss  
applique / plafonnier; aluminium, acier, chrome / plastique, blanc

L 1085, B 160, H 125



32W 4500lm

### 31995 RONCADE

wall / ceiling light; aluminium, steel, chrome / plastic, white  
Wand- / Deckenleuchte; Alu, Stahl, chrom / Kunststoff, weiss  
applique / plafonnier; aluminium, acier, chrome / plastique, blanc

L 650, B 130, H 45



21W 2800lm

### 96329 SELVINA

ceiling light; aluminium, chrome / plastic, white  
Deckenleuchte; Alu, chrom / Kunststoff, weiss  
plafonnier; aluminium, chrome / plastique, blanc

L 700, B 420, H 150



19W 2700lm



9 002759 319960



9 002759 319953

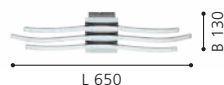

9 002759 963293





96308

LED



96327

LED



96326

LED

### 96308 SELVINA

ceiling light; aluminium, chrome / plastic, white  
Deckenleuchte; Alu, chrom / Kunststoff, weiss  
plafonnier; aluminium, chrome / plastique, blanc

L 745, B 175, H 85

LED

warm  
WHITE  
2900lm



9 002759 963088



### 96327 VALMORA

ceiling light; aluminium, chrome / plastic, white  
Deckenleuchte; Alu, chrom / Kunststoff, weiss  
plafonnier; aluminium, chrome / plastique, blanc

L 560, B 560, H 105

LED

warm  
WHITE  
2450lm



9 002759 963279

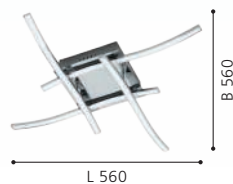

### 96326 VALMORA

ceiling light; aluminium, chrome / plastic, white  
Deckenleuchte; Alu, chrom / Kunststoff, weiss  
plafonnier; aluminium, chrome / plastique, blanc

L 590, B 125, H 90

LED

warm  
WHITE  
1700lm



9 002759 963262

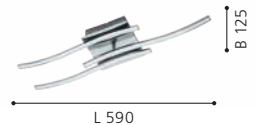



96332



96305

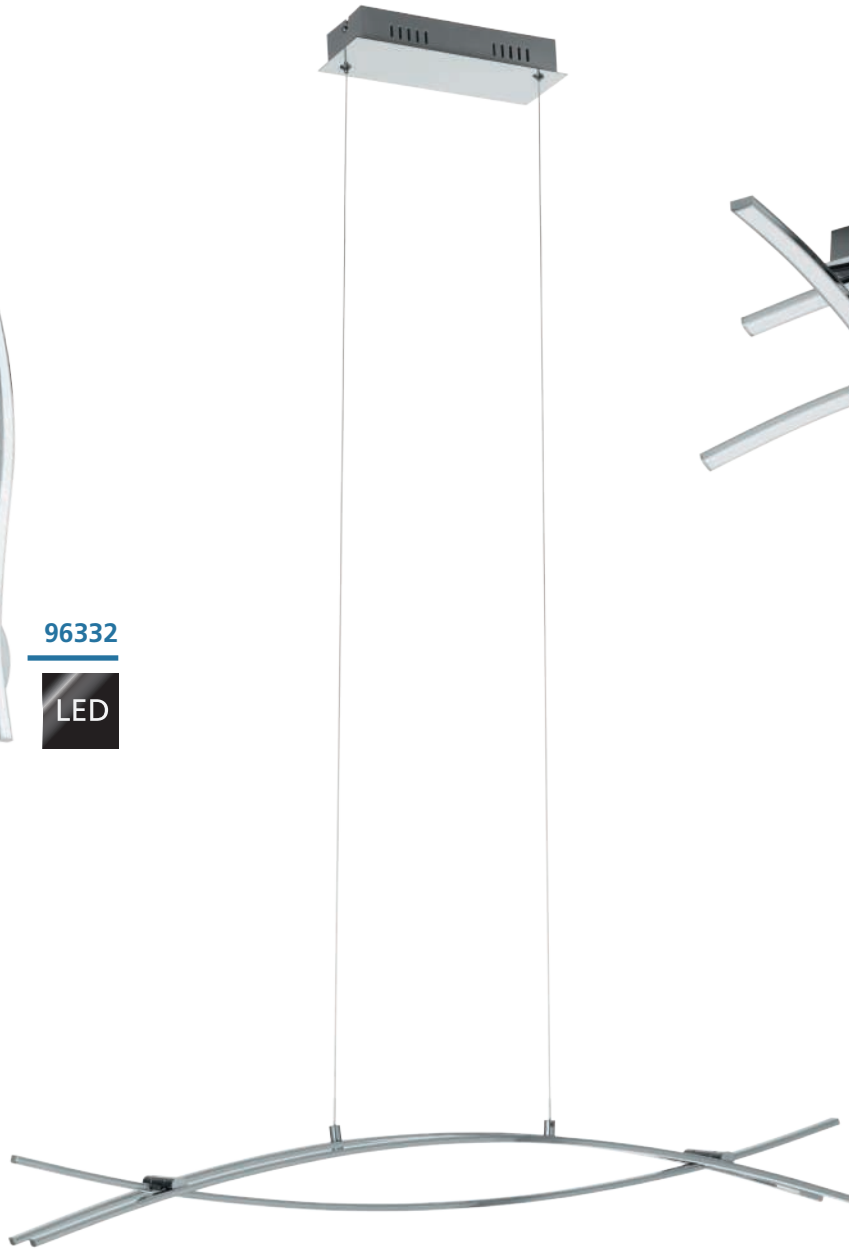

96331



### 96332 VALMORA

wall light; aluminium, chrome / plastic, white  
Wandleuchte; Alu, chrom / Kunststoff, weiss  
applique; aluminium, chrome / plastique, blanc

L 115, H 450, A 90



9W 1250lm



9 002759 963323



### 96331 NEVADO

pendant light; aluminium, chrome / plastic, white  
Hängeleuchte; Alu, chrom / Kunststoff, weiss  
luminaire en suspension; aluminium, chrome / plastique, blanc

L 900, B 80, H 1100



23,6W 3400lm



9 002759 963316

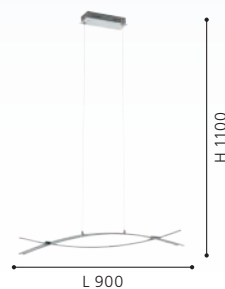

### 96305 NEVADO

ceiling light; aluminium, chrome / plastic, white  
Deckenleuchte; Alu, chrom / Kunststoff, weiss  
plafonnier; aluminium, chrome / plastique, blanc

L 500, B 500, H 115



18W 2450lm



9 002759 963057

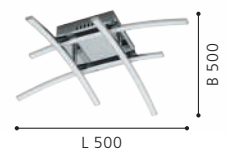



96306

LED



98889

LED



99559

LED

### 96306 SELVINA

ceiling light; aluminium, chrome / plastic, white  
Deckenleuchte; Alu, chrom / Kunststoff, weiss  
plafonnier; aluminium, chrome / plastique, blanc

L 460, B 390, H 380



28W



3600lm



### 98889 PALOZZA 1

wall light; aluminium, satin nickel / plastic, white  
Wandleuchte; Alu, nickel-matt / Kunststoff, weiss  
applique; aluminium, nickel mat / plastique, blanc

L 170, H 425, A 60



10W



1300lm



### 99559 PALOZZA 1

table light; aluminium, satin nickel / plastic, white  
Tischleuchte; Alu, nickel-matt / Kunststoff, weiss  
luminaire de table; aluminium, nickel mat / plastique, blanc

L 150, B 110, H 420



11W



1400lm



9 002759 963064

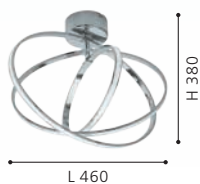

9 002759 988890



9 002759 995591

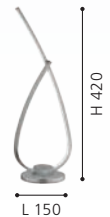



### 31997 RONCADE

table light; aluminium, steel, chrome / plastic, white  
Tischleuchte; Alu, Stahl, chrom / Kunststoff, weiss  
luminaire de table; aluminium, acier, chrome / plastique, blanc

L 195, B 150, H 335

LED

8,8W

warm  
WHITE

866lm



9 002759 319977



31997

LED



97362



97361



97363



### 97362 PALOZZA

pendant light; aluminium, rose gold / plastic, white  
Hängeleuchte; Alu, roségold / Kunststoff, weiss  
luminaire en suspension; aluminium, rose or / plastique, blanc

L 705, B 315, H 1100

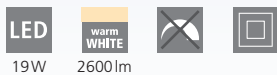

19W 2600lm



9 002759 973629



### 97361 PALOZZA

ceiling light; aluminium, rose gold / plastic, white  
Deckenleuchte; Alu, roségold / Kunststoff, weiss  
plafonnier; aluminium, rose or / plastique, blanc

L 705, B 315, H 125



19W 2700lm



9 002759 973612

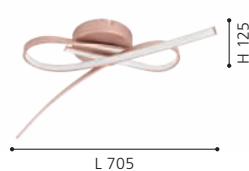

### 97363 PALOZZA

wall light; aluminium, rose gold / plastic, white  
Wandleuchte; Alu, roségold / Kunststoff, weiss  
applique; aluminium, rose or / plastique, blanc

L 170, H 425, A 60



9W 1400lm



9 002759 973636





97364

LED

### 97364 PALOZZA

table light; aluminium, rose gold / plastic, white  
Tischleuchte; Alu, roségold / Kunststoff, weiss  
luminaire de table; aluminium, rose or / plastique, blanc

H 380, Ø 185, Base: Ø 150

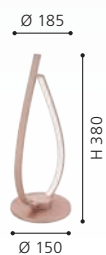

# LIGHTING FAMILIES

GLASS CHANDELIERS  
GLASLUSTER  
LUSTRES EN VERRE

## SPARKLING

Extravagant lighting – our glass chandeliers will give you light in a new diversity while ensuring an extraordinary ambience. Our chandeliers are true jewels on your ceiling and spread their elegance in your entire living area.

## FUNKELN

Beleuchtung der Extravaganz – Mit unseren Glaslustern erleben Sie Licht in neuer Vielfalt und sorgen für ein außergewöhnliches Ambiente. Unsere Kronleuchter werden zum wahren Schmuckstück und bringen Eleganz in all Ihre Wohnbereiche.

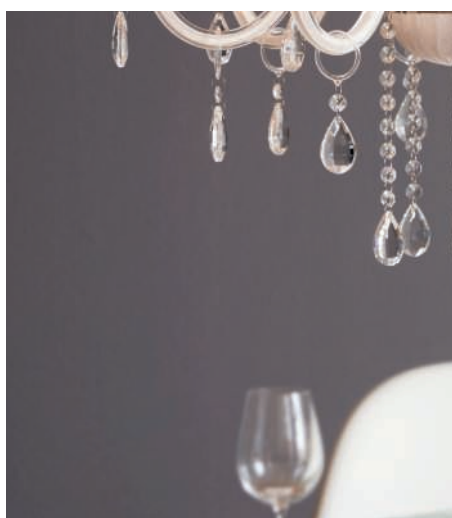

## DU SCINTILLEMENT

Un éclairage riche en extravagance – Avec nos lustres en verre, vous faites l'expérience de la lumière dans une nouvelle multiplicité et vous assurez une ambiance extraordinaire. Nos plafonniers lustres en deviennent de vrais bijoux et prêtent de l'élégance à tous vos espaces d'habitat.





# OVERVIEW

LIGHTING FAMILIES / GLASS CHANDELIERS



BASILANO 1  
p. 320-321



BASILANO  
p. 322-323



CARPENTIO  
p. 324



This product is available in different colors and shapes./ Dieser Artikel ist in unterschiedlichen Farben und Formen verfügbar.  
Cet article est disponible en différentes couleurs et formes.





39103



39101

### 39103 BASILANO 1

pendant light; steel, chrome / glass, clear  
 Hängeleuchte; Stahl, chrom / Glas, klar  
 luminaire en suspension; acier, chrome / verre, transparent

H 1500, Ø 1000



E14 18x40W



9 002759 391034

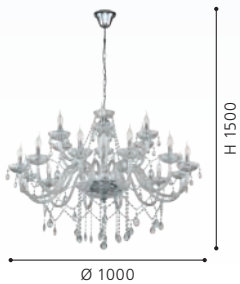

H 1500

Ø 1000

### 39101 BASILANO 1

pendant light; steel, chrome / glass, clear  
 Hängeleuchte; Stahl, chrom / Glas, klar  
 luminaire en suspension; acier, chrome / verre, transparent

H 1300, Ø 820



E14 8x40W



9 002759 391010



H 1300

Ø 820

### 39099 BASILANO 1

pendant light; steel, chrome / glass, clear  
 Hängeleuchte; Stahl, chrom / Glas, klar  
 luminaire en suspension; acier, chrome / verre, transparent

H 1300, Ø 720

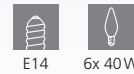

E14 6x40W



9 002759 390990



H 1300

Ø 720





39099



39102

### 39102 BASILANO 1

pendant light; steel, chrome / glass, clear

Hängeleuchte; Stahl, chrom / Glas, klar

luminaire en suspension; acier, chrome / verre, transparent

H 1500, Ø 1000



E14



12x 40W



9 002759 391027



H 1500

Ø 1000



39095



39092

### 39095 BASILANO

pendant light; steel, chrome / glass, cognac  
 Hängeleuchte; Stahl, chrom / Glas, cognac  
 luminaire en suspension; acier, chrome / verre, cognac

H 1500, Ø 1000



E14 18x 40W



9 002759 390952



### 39092 BASILANO

pendant light; steel, chrome / glass, cognac  
 Hängeleuchte; Stahl, chrom / Glas, cognac  
 luminaire en suspension; acier, chrome / verre, cognac

H 1300, Ø 720



E14 6x 40W



9 002759 390921







**39093**



**39094**

### 39093 BASILANO

pendant light; steel, chrome / glass, cognac  
 Hängeleuchte; Stahl, chrom / Glas, cognac  
 luminaire en suspension; acier, chrome / verre, cognac

H 1300, Ø 820



E14 8x 40W



9 002759 390938



### 39094 BASILANO

pendant light; steel, chrome / glass, cognac  
 Hängeleuchte; Stahl, chrom / Glas, cognac  
 luminaire en suspension; acier, chrome / verre, cognac

H 1500, Ø 1000



E14 12x 40W



9 002759 390945





**39113**

### 39113 CARPENTO

pendant light; steel, chrome / glass, white  
 Hängeleuchte; Stahl, chrom / Glas, weiss  
 luminaire en suspension; acier, chrome / verre, blanc

H 1200, Ø 590



E14

5x 40W



9 002759 391133



### 39114 CARPENTO

pendant light; steel, chrome / glass, white  
 Hängeleuchte; Stahl, chrom / Glas, weiss  
 luminaire en suspension; acier, chrome / verre, blanc

H 1300, Ø 700



E14

8x 40W



9 002759 391140







39114



# HANGING & PENDANT LUMINAIRES

HÄNGE- & PENDELLEUCHTEN  
LUMINAIRES SUSPENSIONS

## SUSPENDED LIGHTING

Our wide variety of suspended and pendant luminaires contain classical as well as extravagant designs and supply any furnishing style. Set beautiful accents with your favourites and give your home a special atmosphere.

## BELEUCHTUNG ZUM ABHÄNGEN

Unser breitgefächertes Hänge- und Pendelleuchten-Sortiment beinhaltet sowohl klassische als auch extravagante Designs und bedient jeden Einrichtungsstil. Setzen Sie mit Ihren Favoriten schöne Akzente und verleihen Sie Ihrem Zuhause eine besondere Atmosphäre.



## ÉCLAIRAGES SUSPENDUS

























































Notre large gamme d'éclairages suspendus et pendulaires comprend aussi bien des designs classiques qu'extravagants et est adaptée à tout style d'ameublement. Mettez avec vos favoris de beaux accents et donnez une atmosphère particulière à votre intérieur.







# OVERVIEW

## HANGING & PENDANT LUMINAIRES

 OILELLA p. 330-331	 AGUILARES p. 332	 LEBALIO p. 333	 MARYVILLA p. 334	 ALOBRASE p. 335-339	 BATISTA p. 335	 CADAQUES p. 340	 CADAQUES 1 p. 340
 TORRONTES p. 340	 ARISCANI p. 342-343	 MURMILLO p. 344	 FARSALA p. 345	 BELESER p. 346-766	 MANTUNALLE 1 p. 347	 MANTUNALLE p. 348	 SELVINO p. 350-351
 ALBARACCIN p. 352-353	 LAGUNITAS p. 354	 CERASELLA p. 355	 ROCAMAR p. 356, 358	 ROCAMAR 1 p. 357-358	 CORETTO p. 357	 LONCINO 1 p. 359	 ALEANDRO 1 p. 360
 ROMAGNESE p. 360	 VALLASPRA p. 361	 BATISTA 3 p. 361	 BOLSANO p. 362	 CLEMENTE p. 363	 CARDITO 1 p. 364	 FEDRA 2 p. 365	 VARRAZO p. 365
 LUBERIO p. 366	 MONTEFIO 1 p. 366-367	 MIOGLIA 1 p. 368	 CONESSA p. 368-369	 ENALURI p. 370	 CARTAMA p. 371	 MONTEFINO p. 372	 CORTENOVA p. 374
 POZUETA p. 377	 BOCADELLA p. 378	 MEZZANA p. 378	 GRADOLI p. 380	 GRADOLI 1 p. 381	 MANIZALES p. 381	 CUMIOLE p. 382	 MONTEBALDO p. 383
 BITACHITO p. 383	 CORTADERAS p. 384	 SARONA p. 386	 LOBATIA p. 387	 SILVARES p. 388	 TAREGA p. 389	 GATUELA 1 p. 390	 GATUELA p. 391

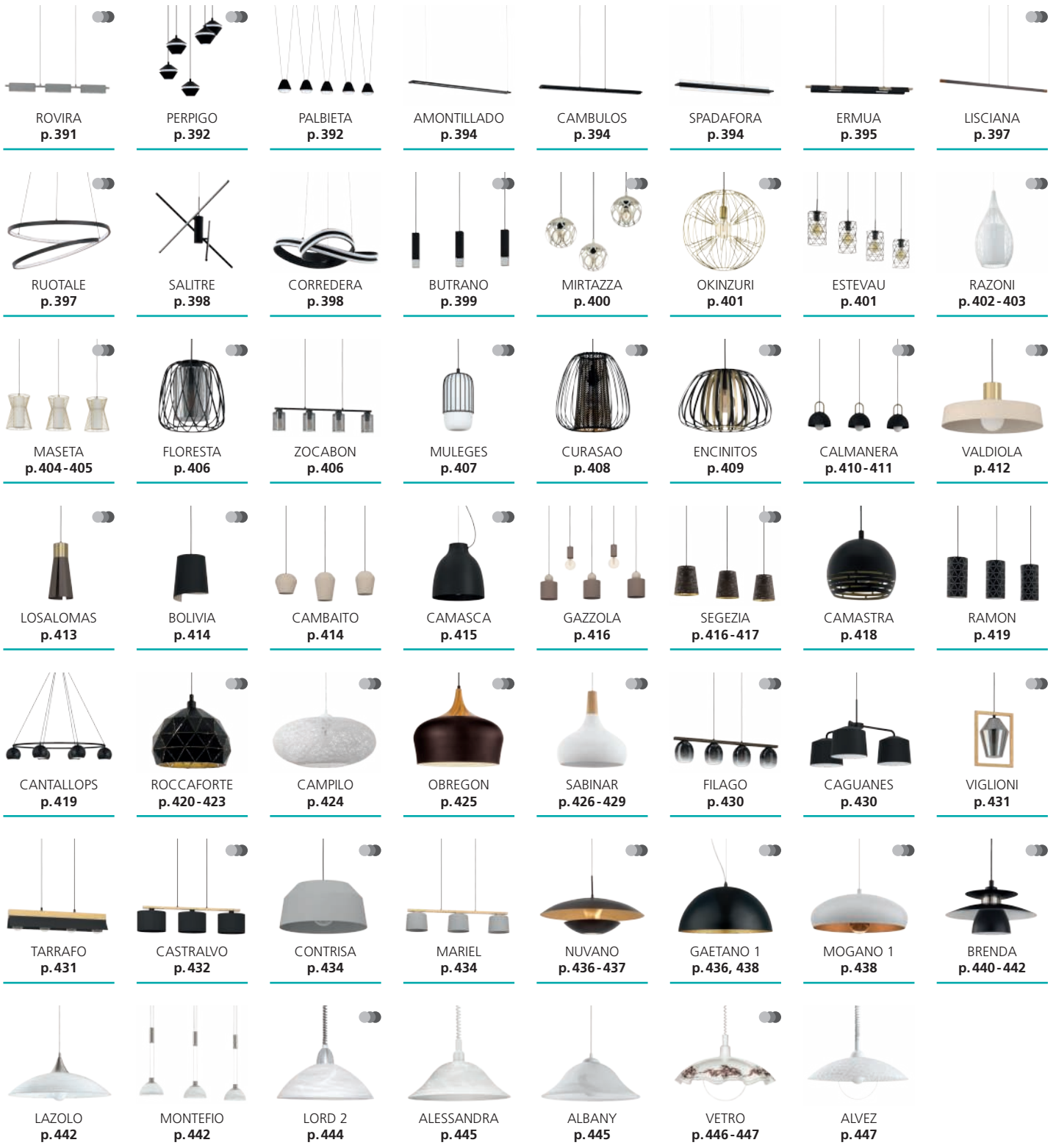



 This product is available in different colors and shapes./ Dieser Artikel ist in unterschiedlichen Farben und Formen verfügbar.  
Cet article est disponible en différentes couleurs et formes.



### 99614 OILELLA

pendant light; steel, black, brass / glass vaporized, black-brown-transparent

Hängeleuchte; Stahl, schwarz, messing / Glas bedampft, schwarz-braun-transparent

luminaire en suspension; acier, noir, laiton / verre vaporisé, noir-marron-transparent

H 1100, Ø 190



E27

1x 40W



9 002759 996147



### 99615 OILELLA

pendant light; steel, black, brass / glass vaporized, black-brown-transparent

Hängeleuchte; Stahl, schwarz, messing / Glas bedampft, schwarz-braun-transparent

luminaire en suspension; acier, noir, laiton / verre vaporisé, noir-marron-transparent

L 950, B 190, H 1100



E27

3x 40W



9 002759 996154



### 99616 OILELLA

pendant light; steel, black, brass / glass vaporized, black-grey-transparent

Hängeleuchte; Stahl, schwarz, messing / Glas bedampft, schwarz-grau-transparent

luminaire en suspension; acier, noir, laiton / verre vaporisé, noir-gris-transparent

H 1100, Ø 190



E27

1x 40W



9 002759 996161





99617



### 99617 OILELLA

pendant light; steel, black, brass / glass vaporized,  
black-grey-transparent

Hängeleuchte; Stahl, schwarz, messing / Glas bedampft,  
schwarz-grau-transparent

luminaire en suspension; acier, noir, laiton / verre vaporisé,  
noir-gris-transparent

L 950, B 190, H 1100



E27



3x 40W



9 002759 996178





**900195**



**900196**



**900195 AGUILARES**

pendant light; steel, black / glass vaporized, black-grey-transparent

Hängeleuchte; Stahl, schwarz / Glas bedampft, schwarz-grau-transparent

luminaire en suspension; acier, noir / verre vaporisé, noir-gris-transparent

L 840, B 195, H 1045



E27



3x 40W



9 008606 235551



**900196 AGUILARES**

pendant light; steel, black / glass vaporized, black-grey-transparent

Hängeleuchte; Stahl, schwarz / Glas bedampft, schwarz-grau-transparent

luminaire en suspension; acier, noir / verre vaporisé, noir-gris-transparent

H 1100, Ø 430



E27



3x 40W



9 008606 235568







99314

### 99314 LEBALIO

pendant light; steel, bronzed / glass vaporized, black-transparent

Hängeleuchte; Stahl, brüniert / Glas bedampft, schwarz-transparent

luminaire en suspension; acier, brun / verre vaporisé, noir transparent

L 1125, B 195, H 1100



E27



3x 40W



9 002759 993146

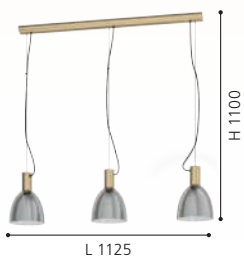

99314

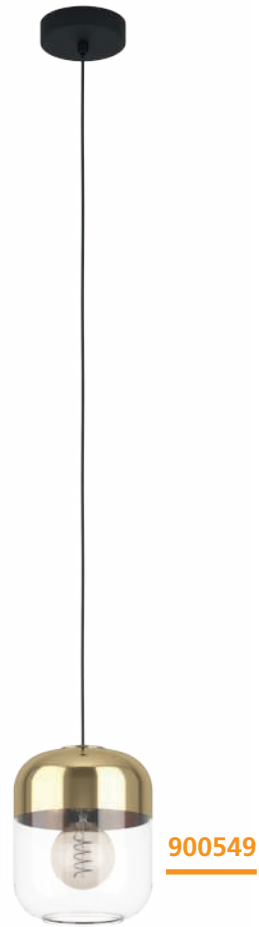

MARYVILLA

### 900549 MARYVILLA

pendant light; steel, black, bronzed / glass vaporized, clear, gold  
 Hängeleuchte; Stahl, schwarz, brüniert / Glas bedampft, klar, gold  
 luminaire en suspension; acier, noir, brun / verre vaporisé, transparent, or

H 1100, Ø 170



### 900551 MARYVILLA

pendant light; steel, black, bronzed / glass vaporized, clear, gold  
 Hängeleuchte; Stahl, schwarz, brüniert / Glas bedampft, klar, gold  
 luminaire en suspension; acier, noir, brun / verre vaporisé, transparent, or

L 870, B 170, H 1100



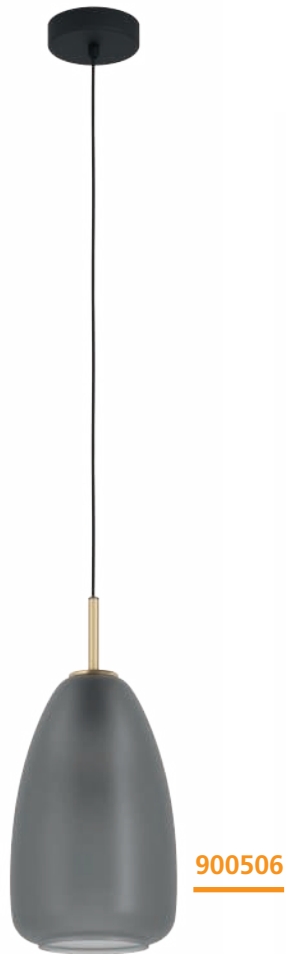

900506

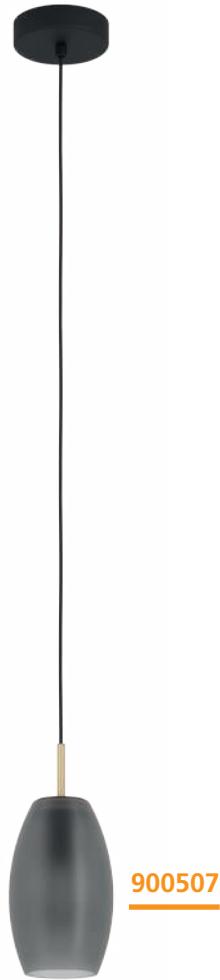

900507



900506 | 900507 | 900508



900508

### 900506 ALOBRASE

pendant light; steel, black, brushed brass / satin glass, grey matt  
 Hängeleuchte; Stahl, schwarz, messing-gebürstet / Glas satiniert, grau matt  
 luminaire en suspension; acier, noir, laiton brossé / verre satiné, gris mat

H 1100, Ø 200



E27 1x 40W



9 008606 244362

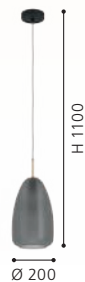

### 900507 BATISTA

pendant light; steel, black, brushed brass / satin glass, grey matt  
 Hängeleuchte; Stahl, schwarz, messing-gebürstet / Glas satiniert, grau matt  
 luminaire en suspension; acier, noir, laiton brossé / verre satiné, gris mat

H 1100, Ø 120



E27 1x 40W



9 008606 244379

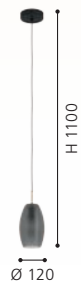

### 900508 BATISTA

pendant light; steel, black, brushed brass / satin glass, grey matt  
 Hängeleuchte; Stahl, schwarz, messing-gebürstet / Glas satiniert, grau matt  
 luminaire en suspension; acier, noir, laiton brossé / verre satiné, gris mat

L 945, B 120, H 1100



E27 4x 40W



9 008606 244386

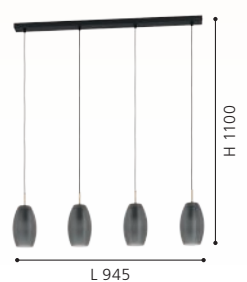



**98614**

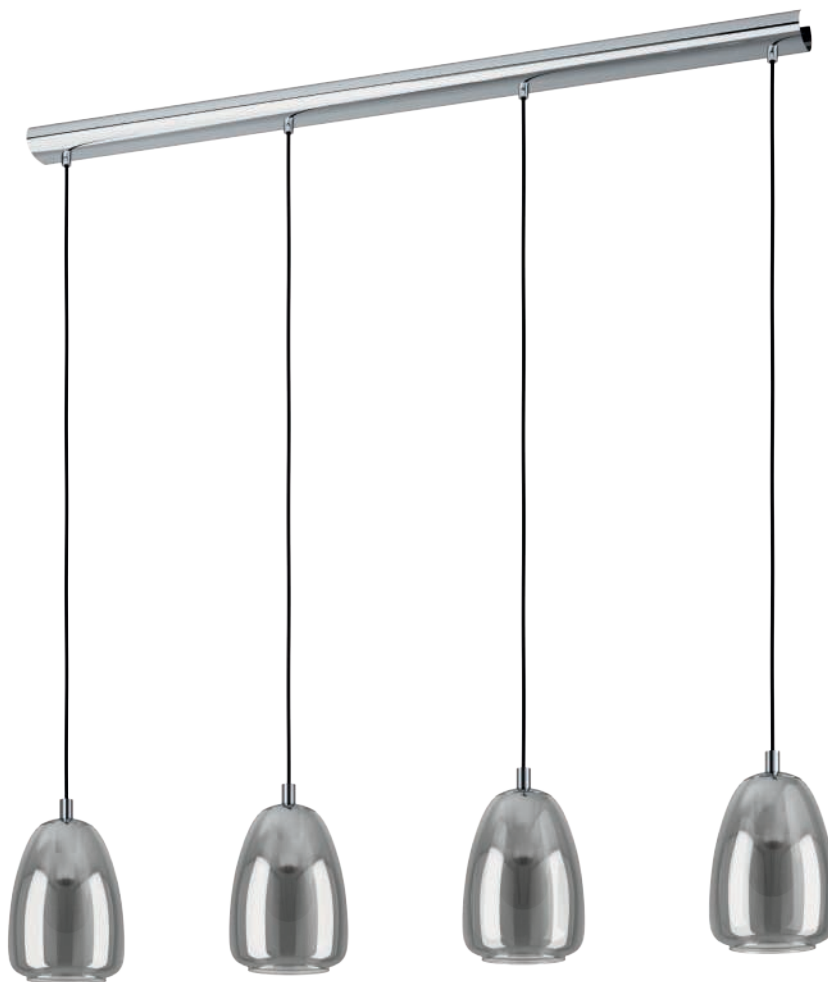

**98616**



EGLO  
RECOMMENDS  
**110003**

ALOBRASE

### 98614 ALOBRASE

pendant light; steel, chrome / glass vaporized, black-transparent  
Hängeleuchte; Stahl, chrom / Glas bedampft, schwarz-transparent  
luminaire en suspension; acier, chrome / verre vaporisé, noir transparent

H 1100, Ø 300



E27 1x 40W



9 002759 986148



### 98616 ALOBRASE

pendant light; steel, chrome / glass vaporized, black-transparent  
Hängeleuchte; Stahl, chrom / Glas bedampft, schwarz-transparent  
luminaire en suspension; acier, chrome / verre vaporisé, noir transparent

L 1080, B 150, H 1100



E27 4x 40W



9 002759 986162



### 98615 ALOBRASE

pendant light; steel, chrome / glass vaporized, black-transparent  
Hängeleuchte; Stahl, chrom / Glas bedampft, schwarz-transparent  
luminaire en suspension; acier, chrome / verre vaporisé, noir transparent

H 1100, Ø 200



E27 1x 40W



9 002759 986155





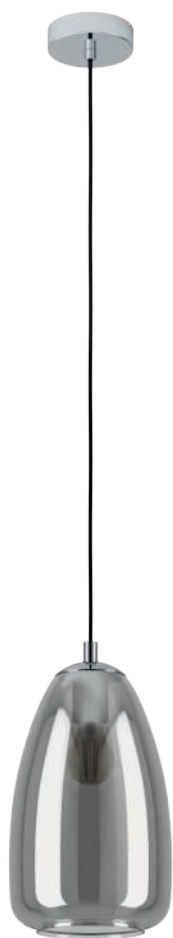

98615

### 98617 ALOBRASE

pendant light; steel, chrome / glass vaporized, black-transparent  
Hängeleuchte; Stahl, chrom / Glas bedampft, schwarz-transparent  
luminaire en suspension; acier, chrome / verre vaporisé, noir transparent

H 1500, Ø 540



E27



5x 40W



9 002759 986179



98617



98647





98648

98649

### 98647 ALOBRASE

pendant light; steel, brushed brass / glass vaporized, amber  
 Hängeleuchte; Stahl, messing-gebürstet / Glas bedampft, amber  
 luminaire en suspension; acier, laiton brossé / verre vaporisé, ambre

H 1100, Ø 300



E27 1x 40W



9 002759 986476



### 98648 ALOBRASE

pendant light; steel, brushed brass / glass vaporized, amber  
 Hängeleuchte; Stahl, messing-gebürstet / Glas bedampft, amber  
 luminaire en suspension; acier, laiton brossé / verre vaporisé, ambre

H 1100, Ø 200



E27 1x 40W



9 002759 986483

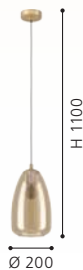

### 98649 ALOBRASE

pendant light; steel, brushed brass / glass vaporized, amber  
 Hängeleuchte; Stahl, messing-gebürstet / Glas bedampft, amber  
 luminaire en suspension; acier, laiton brossé / verre vaporisé, ambre

L 1080, B 150, H 1100



E27 4x 40W



9 002759 986490



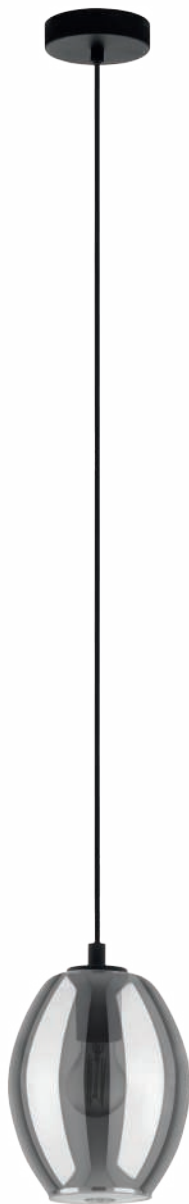

98582 | 98585

**98582**



**98585**



98291

### 98582 CADAQUES

pendant light; steel, black / smoked glass, black-transparent  
Hängeleuchte; Stahl, schwarz / Rauchglas, schwarz-transparent  
luminaire en suspension; acier, noir / verre fumé, noir transparent

H 1100, Ø 180



9 002759 985820



### 98585 CADAQUES 1

pendant light; steel, black / smoked glass, black-transparent  
Hängeleuchte; Stahl, schwarz / Rauchglas, schwarz-transparent  
luminaire en suspension; acier, noir / verre fumé, noir transparent

H 1100, Ø 160



9 002759 985851



### 98291 TORRONTES

pendant light; steel, nickel-nero / smoked glass, black-transparent  
Hängeleuchte; Stahl, nickel-nero / Rauchglas, schwarz-transparent  
luminaire en suspension; acier, nickel noir / verre fumé, noir transparent

H 1100, Ø 345



9 002759 982911

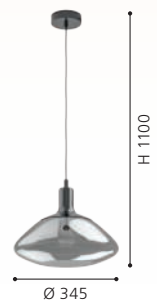



98291





ARISCANI



### 98651 ARISCANI

pendant light; steel, black / glass vaporized, black-transparent  
Hängeleuchte; Stahl, schwarz / Glas bedampft, schwarz-transparent  
luminaire en suspension; acier, noir / verre vaporisé, noir transparent

H 1100, Ø 200



E27 1x 40W



9 002759 986513



### 98652 ARISCANI

pendant light; steel, black / glass vaporized, black-transparent  
Hängeleuchte; Stahl, schwarz / Glas bedampft, schwarz-transparent  
luminaire en suspension; acier, noir / verre vaporisé, noir transparent

L 765, B 165, H 1100



E27 3x 40W



9 002759 986520

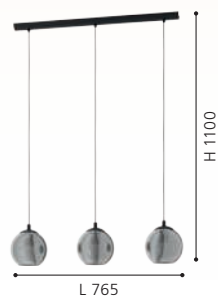



98654



98653

### 98654 ARISCANI

pendant light; steel, black / glass vaporized, black-transparent  
 Hängeleuchte; Stahl, schwarz / Glas bedampft, schwarz-transparent  
 luminaire en suspension; acier, noir / verre vaporisé, noir transparent

H 1700, Ø 655



E27 10x 40W



9 002759 986544



### 98653 ARISCANI

pendant light; steel, black / glass vaporized, black-transparent  
 Hängeleuchte; Stahl, schwarz / Glas bedampft, schwarz-transparent  
 luminaire en suspension; acier, noir / verre vaporisé, noir transparent

H 1100, Ø 425



E27 3x 40W



9 002759 986537

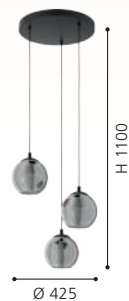





**96774**



**96773**



MURMILLO

### 96774 MURMILLO

pendant light; steel, chrome / smoked glass, black-transparent  
 Hängeleuchte; Stahl, chrom / Rauchglas, schwarz-transparent  
 luminaire en suspension; acier, chrome / verre fumé, noir transparent

L 770, B 170, H 1500



### 96773 MURMILLO

pendant light; steel, chrome / smoked glass, black-transparent  
 Hängeleuchte; Stahl, chrom / Rauchglas, schwarz-transparent  
 luminaire en suspension; acier, chrome / verre fumé, noir transparent

H 1500, Ø 170







96343

LED

96344

LED

96345

LED

### 96343 FARSALA

pendant light; steel, satin nickel / smoked glass, granilla, black-transparent, clear

Hängeleuchte; Stahl, nickel-matt / Rauchglas, Granille, schwarz-transparent, klar

luminaire en suspension; acier, nickel mat / verre fumé, granité, noir transparent, transparent

H 1100, Ø 125



G9



1x 3W



warm WHITE

1x

320lm



9 002759 963439



### 96344 FARSALA

pendant light; steel, satin nickel / smoked glass, granilla, black-transparent, clear

Hängeleuchte; Stahl, nickel-matt / Rauchglas, Granille, schwarz-transparent, klar

luminaire en suspension; acier, nickel mat / verre fumé, granité, noir transparent, transparent

L 975, B 100, H 1100



G9



4x 3W



warm WHITE

4x

320lm



9 002759 963446

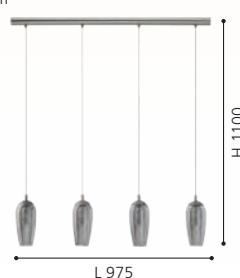

### 96345 FARSALA

pendant light; steel, satin nickel / smoked glass, granilla, black-transparent, clear

Hängeleuchte; Stahl, nickel-matt / Rauchglas, Granille, schwarz-transparent, klar

luminaire en suspension; acier, nickel mat / verre fumé, granité, noir transparent, transparent

H 1500, Ø 350



G9



5x 3W



warm WHITE

5x

320lm



9 002759 963453

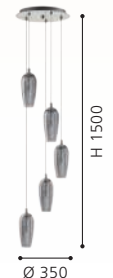



98384



DESIGN  
HIGHLIGHT  
DETAIL

### 98384 BELESER

pendant light; steel, black / glass vaporized, black-transparent  
Hängeleuchte; Stahl, schwarz / Glas bedampft, schwarz-transparent

luminaire en suspension; acier, noir / verre vaporisé, noir transparent

L 905, B 205, H 1100



E27



3x 60W



9 002759 983840





98384 | 99371



99372



99371



99372

### 99371 MANTUNALLE 1

pendant light; steel, black / glass vaporized, black-transparent  
Hängeleuchte; Stahl, schwarz / Glas bedampft, schwarz-transparent  
luminaire en suspension; acier, noir / verre vaporisé, noir transparent

H 1100, Ø 200



9 002759 993719



### 99372 MANTUNALLE 1

pendant light; steel, black / glass vaporized, black-transparent  
Hängeleuchte; Stahl, schwarz / Glas bedampft, schwarz-transparent  
luminaire en suspension; acier, noir / verre vaporisé, noir transparent

L 1200, B 200, H 1100



9 002759 993726

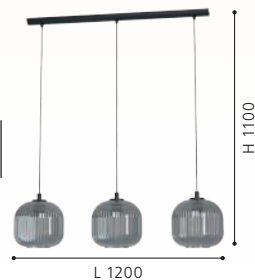



99366



99368



99366



99367 | 99368

### 99366 MANTUNALLE

pendant light; steel, black / glass, white  
Hängeleuchte; Stahl, schwarz / Glas, weiss  
luminaire en suspension; acier, noir / verre, blanc

H 1100, Ø 200



### 99368 MANTUNALLE

pendant light; steel, black / glass, white  
Hängeleuchte; Stahl, schwarz / Glas, weiss  
luminaire en suspension; acier, noir / verre, blanc

H 1100, Ø 620



### 99367 MANTUNALLE

pendant light; steel, black / glass, white  
Hängeleuchte; Stahl, schwarz / Glas, weiss  
luminaire en suspension; acier, noir / verre, blanc

L 1200, B 200, H 1100





99367





**98694**



98694 | 98695



**98695**



**98696**

### 98694 SELVINO

pendant light; steel, satin nickel / glass vaporized, black-transparent

Hängeleuchte; Stahl, nickel-matt / Glas bedampft, schwarz-transparent

luminaire en suspension; acier, nickel mat / verre vaporisé, noir transparent

H 1100, Ø 100



E27



1x 15W



9 002759 986940



### 98695 SELVINO

pendant light; steel, satin nickel / glass vaporized, black-transparent

Hängeleuchte; Stahl, nickel-matt / Glas bedampft, schwarz-transparent

luminaire en suspension; acier, nickel mat / verre vaporisé, noir transparent

L 710, B 100, H 1100



E27



3x 15W



9 002759 986957



### 98696 SELVINO

pendant light; steel, satin nickel / glass vaporized, gold color

Hängeleuchte; Stahl, nickel-matt / Glas bedampft, goldfarben

luminaire en suspension; acier, nickel mat / verre vaporisé, couleur or

H 1100, Ø 100



E27



1x 15W



9 002759 986964





98697



98699



98698



98696 | 98697 | 98698 |  
98699

### 98697 SELVINO

pendant light; steel, satin nickel / glass vaporized, gold color  
Hängeleuchte; Stahl, nickel-matt / Glas bedampft, goldfarben  
luminaire en suspension; acier, nickel mat / verre vaporisé, couleur or

L 710, B 100, H 1100



E27 3x 15W



9 002759 986971

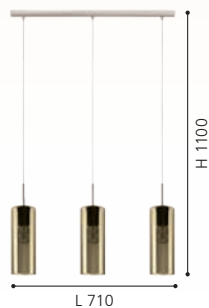

### 98698 SELVINO

pendant light; steel, satin nickel / glass vaporized, copper-coloured  
Hängeleuchte; Stahl, nickel-matt / Glas bedampft, kupferfarben  
luminaire en suspension; acier, nickel mat / verre vaporisé, cuivré

H 1100, Ø 100



E27 1x 15W



9 002759 986988



### 98699 SELVINO

pendant light; steel, satin nickel / glass vaporized, copper-coloured  
Hängeleuchte; Stahl, nickel-matt / Glas bedampft, kupferfarben  
luminaire en suspension; acier, nickel mat / verre vaporisé, cuivré

L 710, B 100, H 1100



E27 3x 15W



9 002759 986995

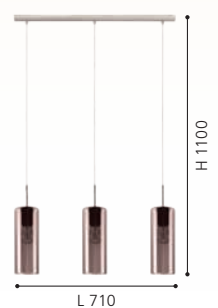

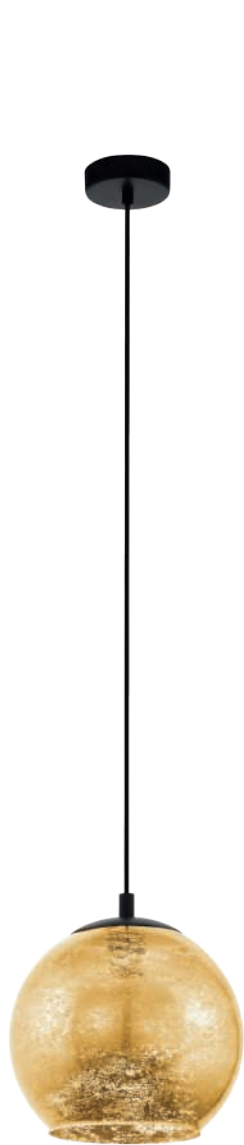

98523

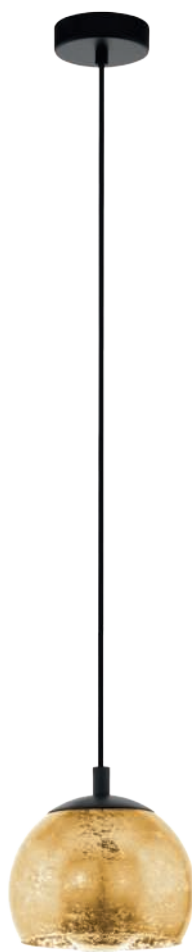

98524



98526

### 98523 ALBARACCIN

pendant light; steel, black / glass, gold color  
Hängeleuchte; Stahl, schwarz / Glas, goldfarben  
luminaire en suspension; acier, noir / verre, couleur or

H 1100, Ø 270



9 002759 985233



### 98524 ALBARACCIN

pendant light; steel, black / glass, gold color  
Hängeleuchte; Stahl, schwarz / Glas, goldfarben  
luminaire en suspension; acier, noir / verre, couleur or

H 1100, Ø 190



9 002759 985240



### 98526 ALBARACCIN

pendant light; steel, black / glass, gold color  
Hängeleuchte; Stahl, schwarz / Glas, goldfarben  
luminaire en suspension; acier, noir / verre, couleur or

H 1500, Ø 585



9 002759 985264







98525

### 98525 ALBARACCIN

pendant light; steel, black / glass, gold color  
 Hängeleuchte; Stahl, schwarz / Glas, goldfarben  
 luminaire en suspension; acier, noir / verre, couleur or

L 780, B 190, H 1100



E27



3x 40W



9 002759 985257





99654



99651

### 99654 LAGUNITAS

pendant light; steel, black, brass, gold / glass, clear  
 Hängeleuchte; Stahl, schwarz, messing, gold / Glas, klar  
 luminaire en suspension; acier, noir, laiton, or / verre, transparent

L 910, B 150, H 1100



E27



3x 40W



9 002759 996543



### 99651 LAGUNITAS

pendant light; steel, black, brass, gold / glass, clear  
 Hängeleuchte; Stahl, schwarz, messing, gold / Glas, klar  
 luminaire en suspension; acier, noir, laiton, or / verre, transparent

H 1100, Ø 150



E27



1x 40W



9 002759 996512



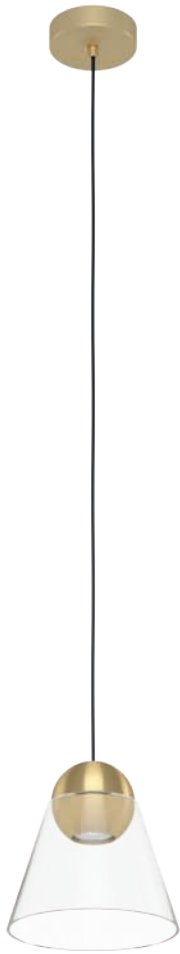

99628

LED



99629

LED



### 99628 CERASELLA

pendant light; steel, brushed brass / glass, clear  
Hängeleuchte; Stahl, messing-gebürstet / Glas, klar  
luminaire en suspension; acier, laiton brossé / verre, transparent

H 1100, Ø 200



GU10



1x 4,5W



1x

345lm



9 002759 996284



INCL.



Ø 200

### 99629 CERASELLA

pendant light; steel, brushed brass / glass, clear  
Hängeleuchte; Stahl, messing-gebürstet / Glas, klar  
luminaire en suspension; acier, laiton brossé / verre, transparent

L 900, B 200, H 1100



GU10



3x 4,5W



3x

345lm



9 002759 996291



INCL.



L 900

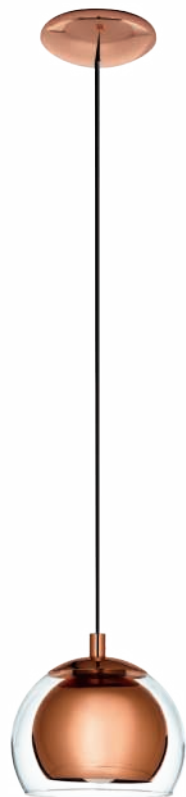

94589

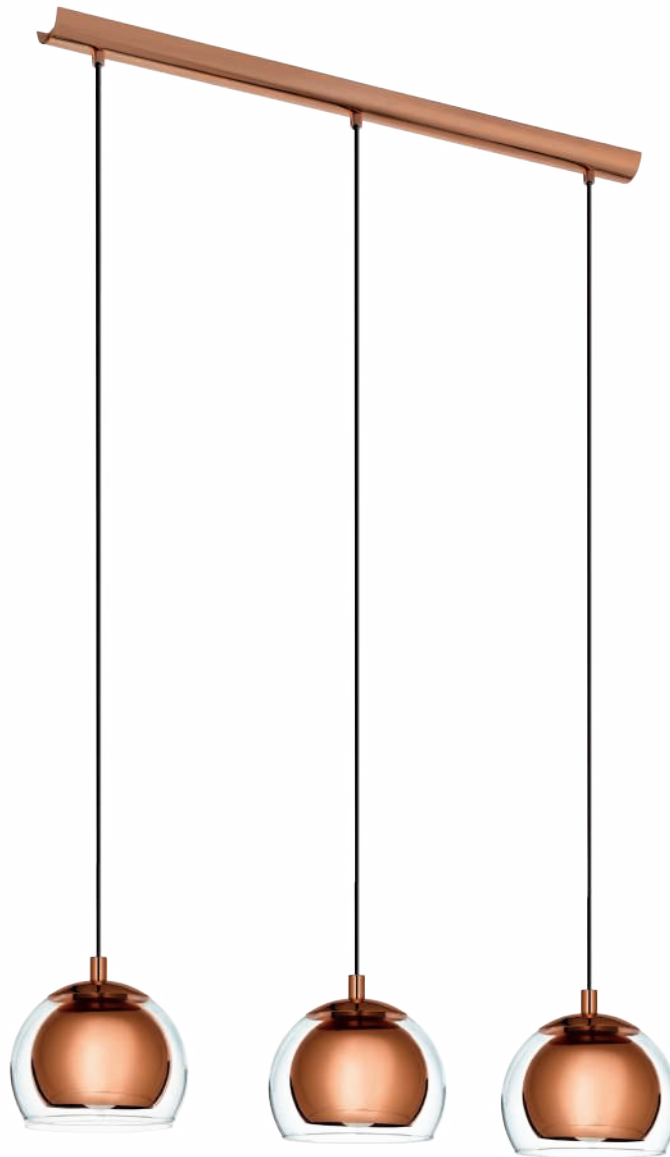

94591



### 94589 ROCAMAR

pendant light; steel, copper / glass, clear  
Hängeleuchte; Stahl, kupfer / Glas, klar  
luminaire en suspension; acier, cuivre / verre, transparent

H 1100, Ø 190



E27 1x 40W



9 002759 945893



### 94591 ROCAMAR

pendant light; steel, copper / glass, clear  
Hängeleuchte; Stahl, kupfer / Glas, klar  
luminaire en suspension; acier, cuivre / verre, transparent

L 780, B 190, H 1100



E27 3x 40W



9 002759 945916







**98595**



**93836**

### 98595 ROCAMAR 1

pendant light; steel, copper / glass, clear  
 Hängeleuchte; Stahl, kupfer / Glas, klar  
 luminaire en suspension; acier, cuivre / verre, transparent

H 1500, Ø 585



9 002759 985950

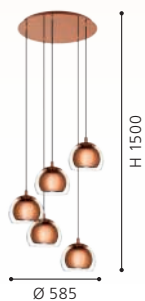

### 93836 CORETTO

pendant light; steel, brushed copper  
 Hängeleuchte; Stahl, kupfer-gebürstet  
 luminaire en suspension; acier, cuivre brossé

H 1100, Ø 170



9 002759 938369





94592

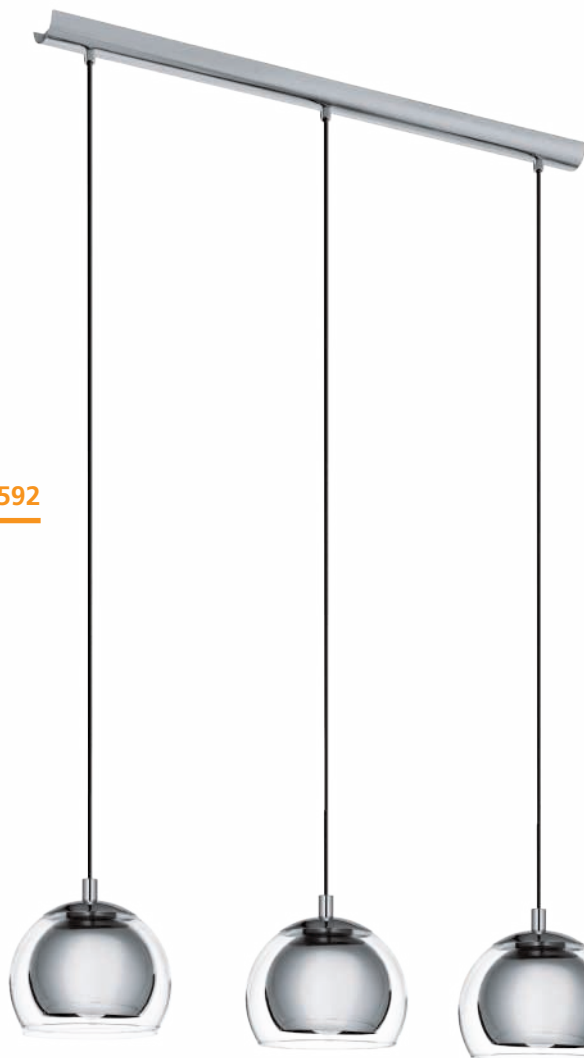

94593



98596

### 94592 ROCAMAR

pendant light; steel, chrome / glass, clear  
Hängeleuchte; Stahl, chrom / Glas, klar  
luminaire en suspension; acier, chrome / verre, transparent

H 1100, Ø 190



E27 1x 40W



9 002759 945923



### 94593 ROCAMAR

pendant light; steel, chrome / glass, clear  
Hängeleuchte; Stahl, chrom / Glas, klar  
luminaire en suspension; acier, chrome / verre, transparent

L 780, B 190, H 1100



E27 3x 40W



9 002759 945930



### 98596 ROCAMAR 1

pendant light; steel, chrome / glass, clear  
Hängeleuchte; Stahl, chrom / Glas, klar  
luminaire en suspension; acier, chrome / verre, transparent

H 1500, Ø 585



E27 5x 28W



9 002759 985967

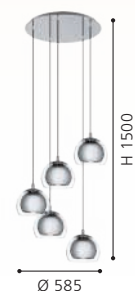



94378



94377

DESIGN  
HIGHLIGHT  
DETAIL



LONGINO 1

### 94378 LONGINO 1

pendant light; steel, chrome / glass, satin glass, clear, white  
Hängeleuchte; Stahl, chrom / Glas, Glas satiniert, klar, weiss  
luminaire en suspension; acier, chrome / verre, verre satiné,  
transparent, blanc

L 745, B 150, H 1100



E27 3x 60W



9 002759 943783



### 94377 LONGINO 1

pendant light; steel, chrome / glass, satin glass, clear, white  
Hängeleuchte; Stahl, chrom / Glas, Glas satiniert, klar, weiss  
luminaire en suspension; acier, chrome / verre, verre satiné,  
transparent, blanc

L 150, B 150, H 1100

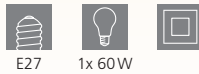

E27 1x 60W



9 002759 943776





96528

LED

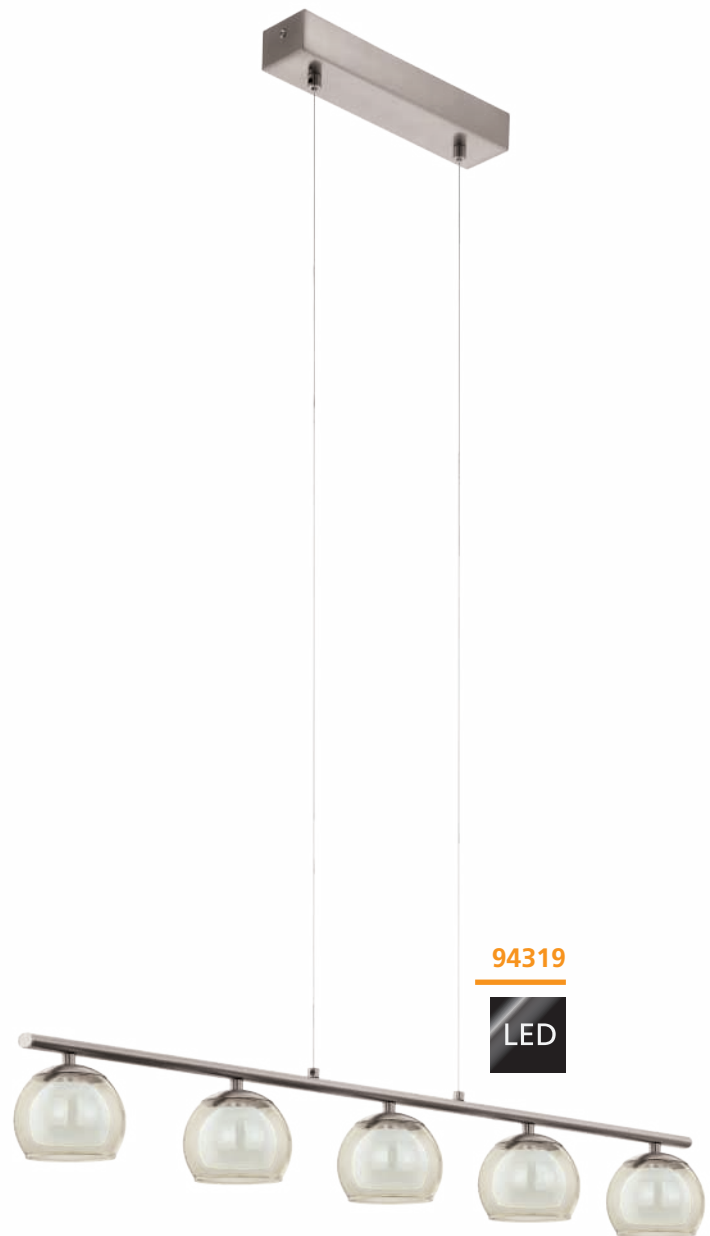

94319

LED

### 96528 ALEANDRO 1

pendant light; steel, chrome / glass opal-matt, white  
 Hängeleuchte; Stahl, chrom / Glas opal-matt, weiss  
 luminaire en suspension; acier, chrome / verre opale mat, blanc

L 800, B 120, H 860 - 1550



4x 4,5W 2000lm



9 002759 965280

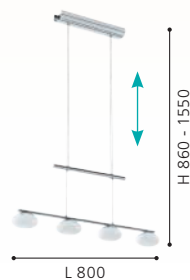

### 94319 ROMAGNESE

pendant light; steel, satin nickel / glass, satin glass, amber, white  
 Hängeleuchte; Stahl, nickel-matt / Glas, Glas satiniert, ambre, weiss  
 luminaire en suspension; acier, nickel mat / verre, verre satiné, ambre, blanc

L 900, B 105, H 1100



5x 3,3W 1700lm



9 002759 943196







97793



97587



97793



97587

### 97793 VALLASPRA

pendant light; steel, champagne / glass opal-matt, white  
 Hängeleuchte; Stahl, champagner / Glas opal-matt, weiss  
 luminaire en suspension; acier, champagne / verre opale mat, blanc

L 910, B 165, H 1100

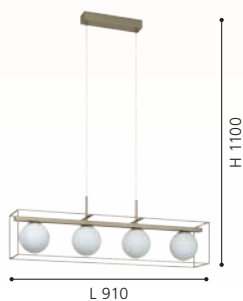

### 97587 BATISTA 3

pendant light; steel, satin nickel / glass wiping technique, white  
 Hängeleuchte; Stahl, nickel-matt / Glas Wischtechnik, weiss  
 luminaire en suspension; acier, nickel mat / technique de verre essuyé, blanc

L 1020, B 120, H 1100





92762



92761

### 92762 BOLSANO

pendant light; steel, chrome / satin glass, glass, white, clear  
 Hängeleuchte; Stahl, chrom / Glas satiniert, Glas, weiss, klar  
 luminaire en suspension; acier, chrome / verre satiné, verre, blanc, transparent

H 1300, Ø 505



E27 3x 60W



9 002759 927622



### 92761 BOLSANO

pendant light; steel, chrome / satin glass, glass, white, clear  
 Hängeleuchte; Stahl, chrom / Glas satiniert, Glas, weiss, klar  
 luminaire en suspension; acier, chrome / verre satiné, verre, blanc, transparent

H 1300, Ø 200



E27 1x 60W



9 002759 927615

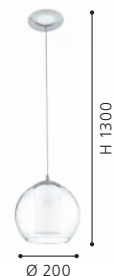



CLEMENTE

95286



95287

### 95286 CLEMENTE

pendant light; steel, chrome / brilliant glass, clear

Hängeleuchte; Stahl, chrom / Brillantglas, klar

luminaire en suspension; acier, chrome / verre brillant, transparent

H 1100, Ø 350



E27



1x 60W



9 002759 952860

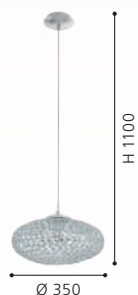

### 95287 CLEMENTE

pendant light; steel, chrome / brilliant glass, clear

Hängeleuchte; Stahl, chrom / Brillantglas, klar

luminaire en suspension; acier, chrome / verre brillant, transparent

H 1100, Ø 540



E27



3x 60W



9 002759 952877

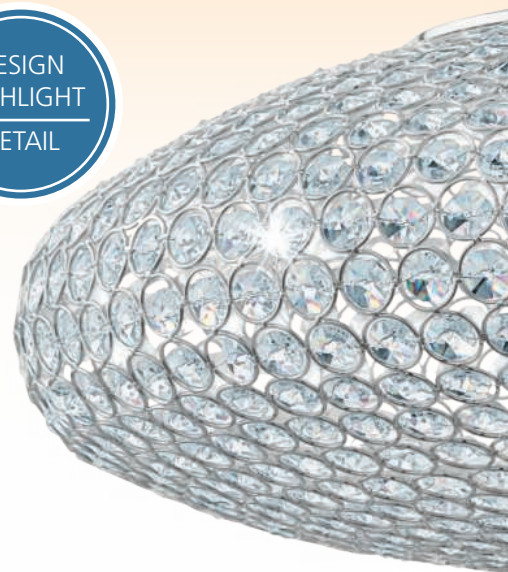



93625

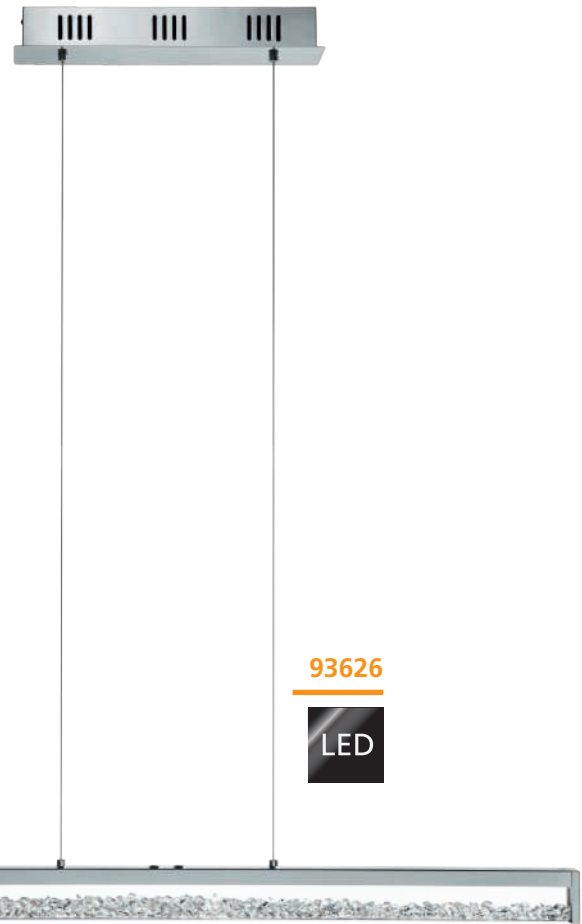

93626

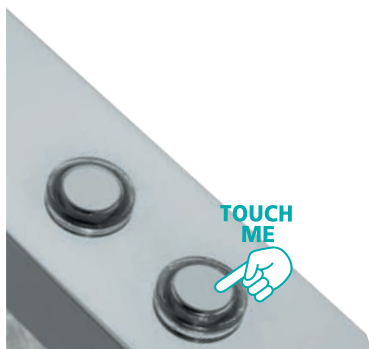

see the tunable white video  
 unser Tunable White Video  
 notre video de blanc réglable

### CARDITO 1



Warm White 2700K    Neutral White    Cold White 5000K

These luminaires can be switched on and off by touching the specially designed "Touch Me" part of the fixture.

Features via touch-dimmer:

- > light colour adjustable between 2700K - 5000K
- > dimmable 10% - 100%

Diese Leuchten können ein und ausgeschaltet werden, indem man sie an den dafür vorgesehenen "Touch Me" Bereichen berührt. Per Touch-Dimmer verfügen diese Leuchten über folgende Funktionen:

- > Lichtfarbe einstellbar im Bereich 2700K bis 5000K
- > dimmbar 10% bis 100%

Ces luminaires peuvent être éteints et allumés simplement en touchant la partie spécialement conçue pour "Touch Me" du luminaire. Fonctions du gradateur "touch":

- > couleur lumineuse réglable de 2700K - 5000K
- > réglable en luminosité 10% - 100%

### 93625 CARDITO 1

pendant light; aluminium, steel, chrome / glass, brilliant glass, clear

Hängeleuchte; Alu, Stahl, chrom / Glas, Brillantglas, klar

luminaire en suspension; aluminium, acier, chrome / verre, verre brillant, transparent

L 700, B 80, H 750 - 1300



4x 6W    2280lm



9 002759 936259

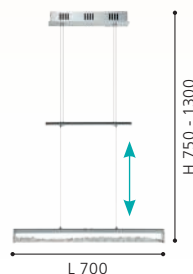

### 93626 CARDITO 1

pendant light; aluminium, steel, chrome / glass, brilliant glass, clear

Hängeleuchte; Alu, Stahl, chrom / Glas, Brillantglas, klar

luminaire en suspension; aluminium, acier, chrome / verre, verre brillant, transparent

L 1000, B 80, H 1100



6x 6W    3420lm



9 002759 936266

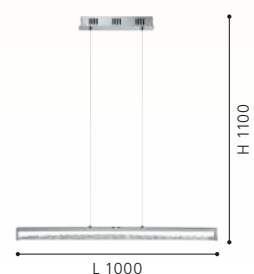





93092



31667

LED

### 93092 FEDRA 2

pendant light; steel, chrome / film, brilliant glass, mother-of-pearl, clear  
 Hängeleuchte; Stahl, chrom / Folie, Brillantglas, perlmutt, klar  
 luminaire en suspension; acier, chrome / film, verre brillant, nacré, transparent

H 1100, Ø 250



9 002759 930929



### 31667 VARRAZO

pendant light; steel, chrome / brilliant glass, clear  
 Hängeleuchte; Stahl, chrom / Brillantglas, klar  
 luminaire en suspension; acier, chrome / verre brillant, transparent

H 1200, Ø 550



9 002759 316679

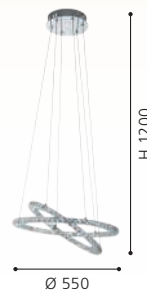

### 93092

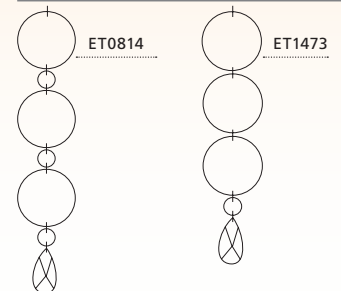

## MONTEFIO 1

These lights are made with high quality brilliant glass.

Diese Leuchten sind mit hochwertigen Brilliant Glas ausgestattet.

Ces lumières sont fabriquées avec une haute qualité Equipé de verre brillant.



93073



93709

LED

### 93073 LUBERIO

pendant light; steel, chrome / glass, aluminium, clear, aluminium  
Hängeleuchte; Stahl, chrom / Glas, Alu, klar, alu  
luminaire en suspension; acier, chrome / verre, aluminium, transparent, aluminium

H 1100, Ø 250



E27



1x 60W



9 002759 930738



### 93709 MONTEFIO 1

pendant light; steel, chrome / glass, brilliant glass, white, clear  
Hängeleuchte; Stahl, chrom / Glas, Brillantglas, weiss, klar  
luminaire en suspension; acier, chrome / verre, verre brillant, blanc, transparent

H 1100, Ø 400



3x 5W



warm WHITE  
1500lm



9 002759 937096

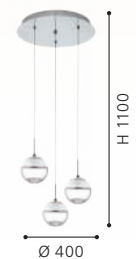

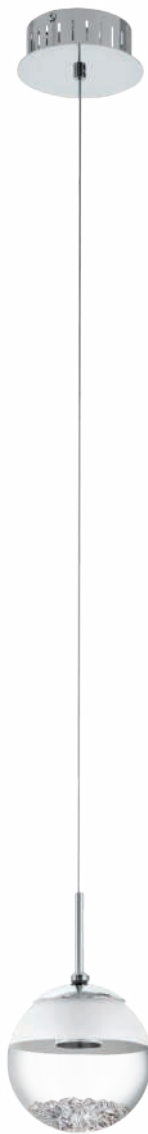

93708

LED



93784

LED

### 93708 MONTEFIO 1

pendant light; steel, chrome / glass, brilliant glass, white, clear  
 Hängeleuchte; Stahl, chrom / Glas, Brillantglas, weiss, klar  
 luminaire en suspension; acier, chrome / verre, verre brillant, blanc, transparent

H 1100, Ø 140



1x 5W 480lm



9 002759 937089



### 93784 MONTEFIO 1

pendant light; steel, chrome / glass, brilliant glass, white, clear  
 Hängeleuchte; Stahl, chrom / Glas, Brillantglas, weiss, klar  
 luminaire en suspension; acier, chrome / verre, verre brillant, blanc, transparent

L 870, B 140, H 1100



3x 5W 1440lm



9 002759 937843



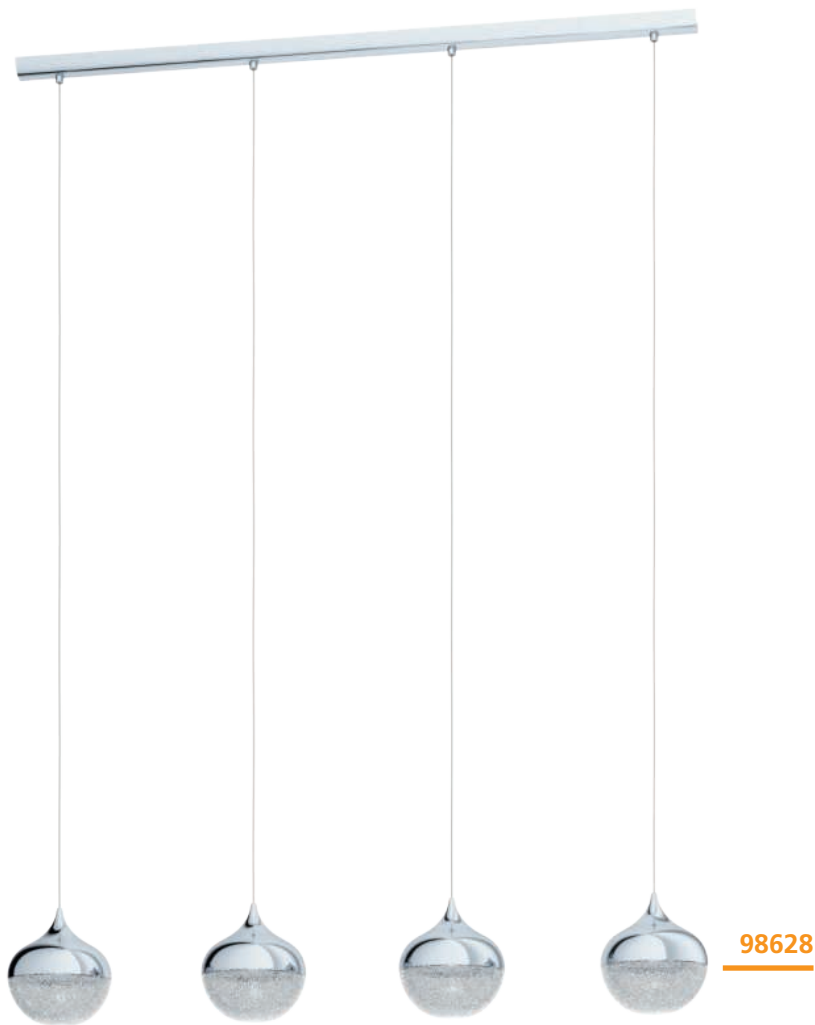

### 98628 MIOGLIA 1

pendant light; steel, chrome / plastic, granille white, clear  
 Hängeleuchte; Stahl, chrom / Kunststoff, granille weiss, klar  
 luminaire en suspension; acier, chrome / plastique, blanc granille, transparent

L 975, B 150, H 1100

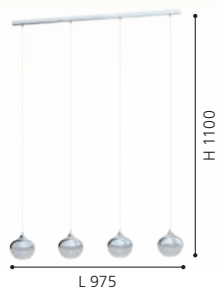

### 98629 MIOGLIA 1

pendant light; steel, chrome / plastic, granille white, clear  
 Hängeleuchte; Stahl, chrom / Kunststoff, granille weiss, klar  
 luminaire en suspension; acier, chrome / plastique, blanc granille, transparent

H 1500, Ø 540



### 95913 CONESSA

pendant light; steel, chrome / plastic, clear  
 Hängeleuchte; Stahl, chrom / Kunststoff, klar  
 luminaire en suspension; acier, chrome / plastique, transparent

H 1100, Ø 290

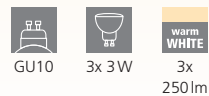





### 95912 CONESSA

pendant light; steel, chrome / plastic, clear  
Hängeleuchte; Stahl, chrom / Kunststoff, klar  
luminaire en suspension; acier, chrome / plastique, transparent

L 1010, B 150, H 1100

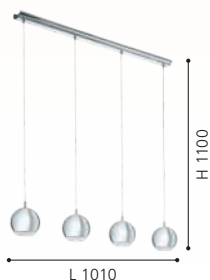
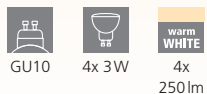

### 95914 CONESSA

pendant light; steel, chrome / plastic, clear  
Hängeleuchte; Stahl, chrom / Kunststoff, klar  
luminaire en suspension; acier, chrome / plastique, transparent

H 1700, Ø 580

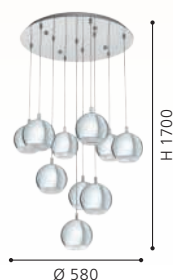



98678

LED



99107

LED

### 98678 ENALURI

pendant light; steel, satin nickel / plastic, satined  
 Hängeleuchte; Stahl, nickel-matt / Kunststoff, satiniert  
 luminaire en suspension; acier, nickel mat / plastique, satiné

L 140, B 105, H 1100

LED

warm  
WHITE



1x 5,4W 630lm



9 002759 986780



### 99107 ENALURI

pendant light; steel, satin nickel / plastic, satined  
 Hängeleuchte; Stahl, nickel-matt / Kunststoff, satiniert  
 luminaire en suspension; acier, nickel mat / plastique, satiné

L 880, B 60, H 1100

LED

warm  
WHITE



4x 5,4W 2520lm



9 002759 991074

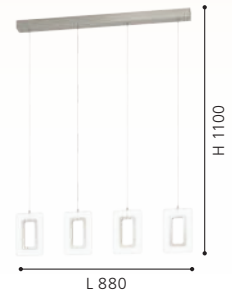

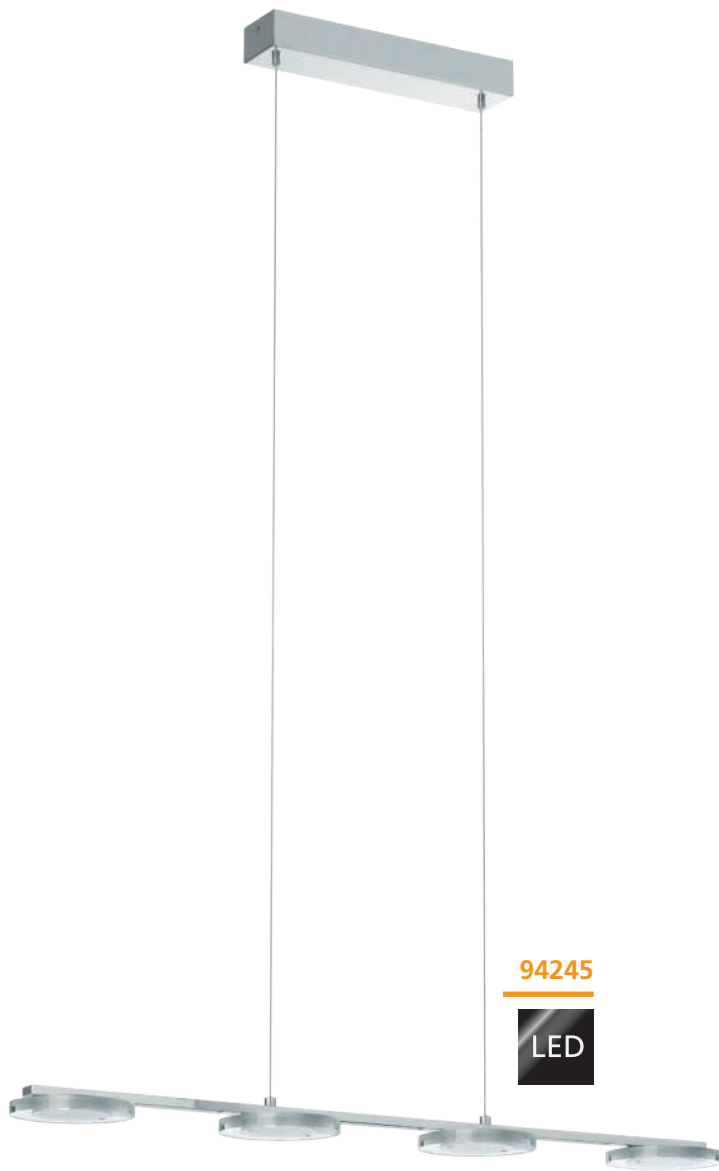

94245

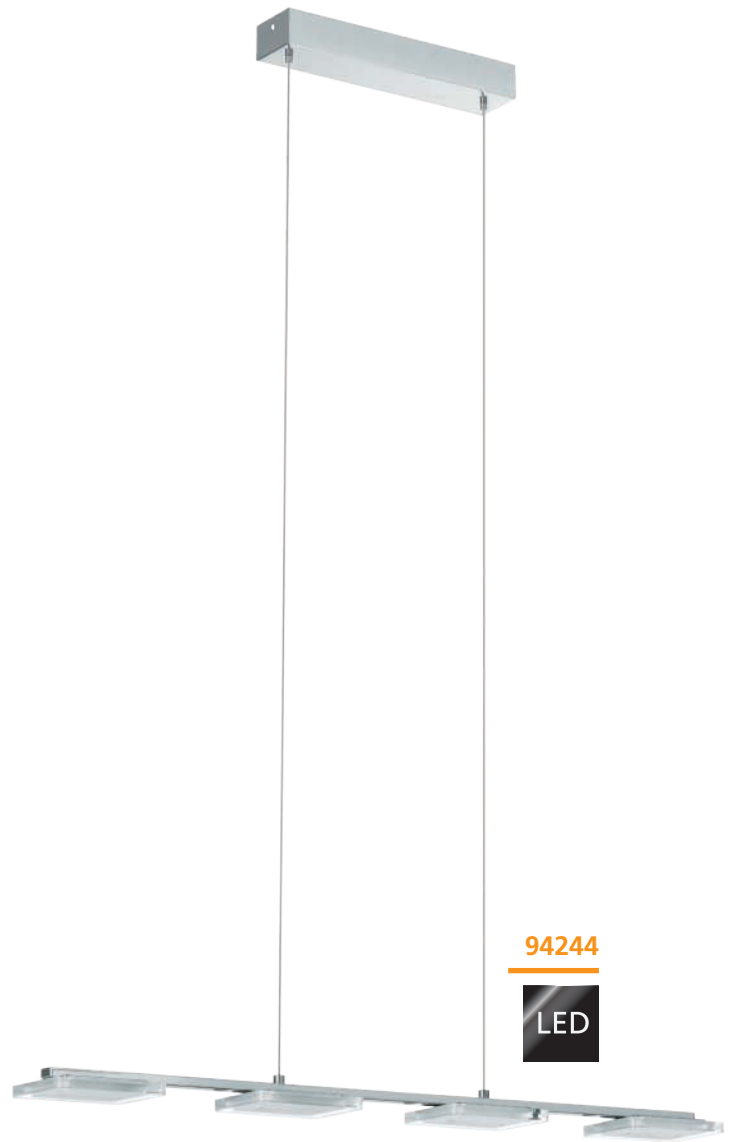

94244



### 94245 CARTAMA

pendant light; steel, chrome / plastic, clear, satined  
 Hängeleuchte; Stahl, chrom / Kunststoff, klar, satiniert  
 luminaire en suspension; acier, chrome / plastique, transparent, satiné

L 775, B 115, H 1100



4x 4,6W 2200lm



9 002759 942458

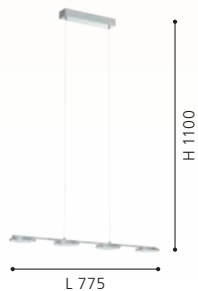

### 94244 CARTAMA

pendant light; steel, chrome / plastic, clear, satined  
 Hängeleuchte; Stahl, chrom / Kunststoff, klar, satiniert  
 luminaire en suspension; acier, chrome / plastique, transparent, satiné

L 780, B 90, H 1100



4x 4,6W 2200lm



9 002759 942441

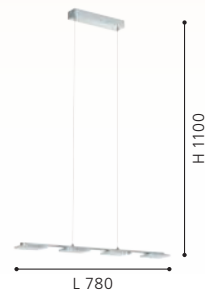



97366

97367

### 97366 MONTEFINO

pendant light; steel, black / glass, clear  
 Hängeleuchte; Stahl, schwarz / Glas, klar  
 luminaire en suspension; acier, noir / verre, transparent

H 1100, Ø 110



9 002759 973667



### 97367 MONTEFINO

pendant light; steel, black / glass, clear  
 Hängeleuchte; Stahl, schwarz / Glas, klar  
 luminaire en suspension; acier, noir / verre, transparent

L 730, B 110, H 1100



9 002759 973674



### 97368 MONTEFINO

pendant light; steel, black / glass, clear  
 Hängeleuchte; Stahl, schwarz / Glas, klar  
 luminaire en suspension; acier, noir / verre, transparent

H 1500, Ø 350



9 002759 973681







97368



98056



98058

### 98056 CORTENOVA

pendant light; steel, black  
Hängeleuchte; Stahl, schwarz  
luminaire en suspension; acier, noir

H 1100, Ø 105



9 002759 980566



### 98058 CORTENOVA

pendant light; steel, black  
Hängeleuchte; Stahl, schwarz  
luminaire en suspension; acier, noir

H 1500, Ø 350



9 002759 980580



### 98057 CORTENOVA

pendant light; steel, black  
Hängeleuchte; Stahl, schwarz  
luminaire en suspension; acier, noir

L 840, B 60, H 1100



9 002759 980573

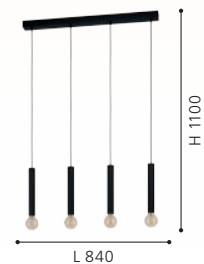



98057





98661







EGLO  
RECOMMENDS  
**110112**

POZUETA



**98663**



**98662**

### 98661 POZUETA

pendant light; steel, black  
Hängeleuchte; Stahl, schwarz  
luminaire en suspension; acier, noir

H 1100, Ø 125



E27 1x 40W



9 002759 986612



### 98663 POZUETA

pendant light; steel, black  
Hängeleuchte; Stahl, schwarz  
luminaire en suspension; acier, noir

H 1500, Ø 330



E27 3x 40W



9 002759 986636



### 98662 POZUETA

pendant light; steel, black  
Hängeleuchte; Stahl, schwarz  
luminaire en suspension; acier, noir

L 840, B 65, H 1100



E27 3x 40W



9 002759 986629





98346



98347

### 98346 BOCADILLA

pendant light; steel, black  
 Hängeleuchte; Stahl, schwarz  
 luminaire en suspension; acier, noir

H 1100, Ø 640



E27



9x 60W



9 002759 983468

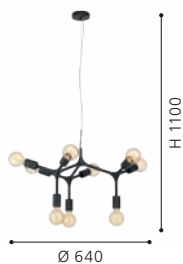

### 98347 BOCADILLA

pendant light; steel, black  
 Hängeleuchte; Stahl, schwarz  
 luminaire en suspension; acier, noir

H 1100, Ø 920



E27



12x 60W



9 002759 983475

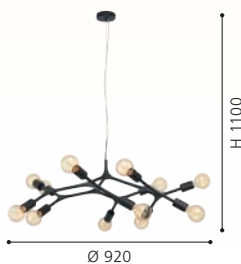

### 98909 MEZZANA

pendant light; steel, black  
 Hängeleuchte; Stahl, schwarz  
 luminaire en suspension; acier, noir

L 650, B 650, H 1100



E27



8x 40W



9 002759 989095

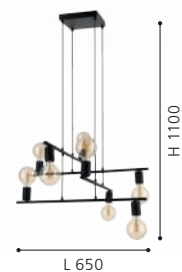



98909



98017



98016



99811

### GRADOLI & GRADOLI 1

The arms of the luminaire can be swiveled individually.

Die Leuchtenarme sind individuell schwenkbar.

Les bras du luminaire peuvent être pivotés individuellement.

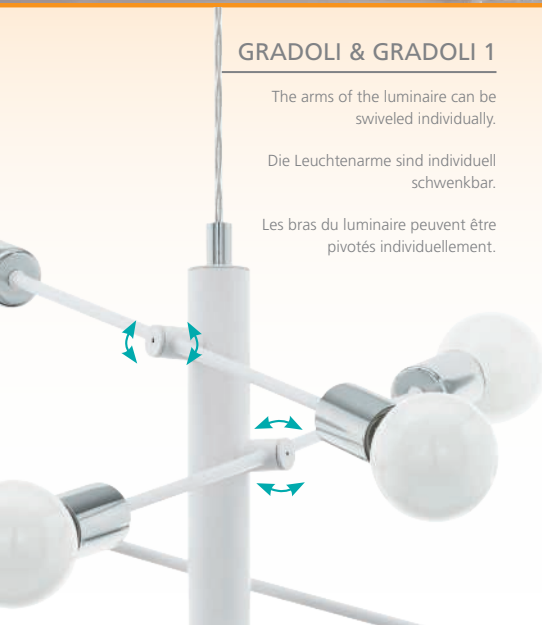

### 98017 GRADOLI

pendant light; steel, white, chrome  
Hängeleuchte; Stahl, weiss, chrom  
luminaire en suspension; acier, blanc, chrome

H 1100, Ø 710



9 002759 980177



### 98016 GRADOLI

pendant light; steel, white, chrome  
Hängeleuchte; Stahl, weiss, chrom  
luminaire en suspension; acier, blanc, chrome

H 1100, Ø 550

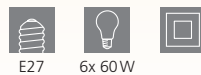

9 002759 980160

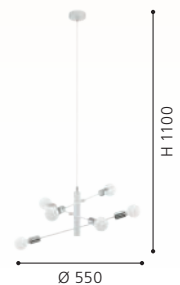





98835



MANIZALES



98834



### 99811 GRADOLI 1

pendant light; steel, brushed brass  
Hängeleuchte; Stahl, messing-gebürstet  
luminaire en suspension; acier, laiton brossé

H 1100, Ø 710



E27 8x 40W



9 002759 998110

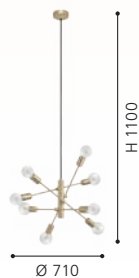

### 98835 MANIZALES

pendant light; steel, brushed brass  
Hängeleuchte; Stahl, messing-gebürstet  
luminaire en suspension; acier, laiton brossé

L 1010, B 50, H 1100



E27 3x 40W



9 002759 988357

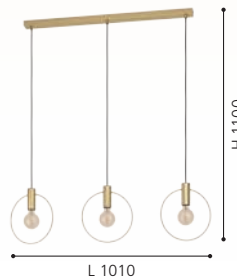

### 98834 MANIZALES

pendant light; steel, brushed brass  
Hängeleuchte; Stahl, messing-gebürstet  
luminaire en suspension; acier, laiton brossé

L 250, B 105, H 1100



E27 1x 40W



9 002759 988340

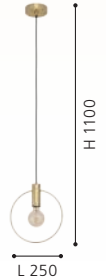



**900399**



**97733**

**LED**

### 900399 CUMIOLE

pendant light; steel, gold-coloured  
Hängeleuchte; Stahl, goldfarben  
luminaire en suspension; acier, or

L 780, B 150, H 1100



E27



3x 40W



9 008606 243754

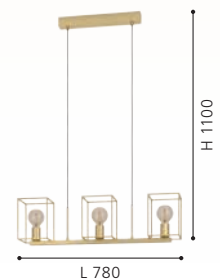



### 97733 MONTEBALDO

pendant light; steel, black, gold  
 Hängeleuchte; Stahl, schwarz, gold  
 luminaire en suspension; acier, noir, or

L 100, B 100, H 1100

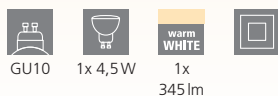

### 97734 MONTEBALDO

pendant light; steel, black, gold  
 Hängeleuchte; Stahl, schwarz, gold  
 luminaire en suspension; acier, noir, or

L 850, B 100, H 1100

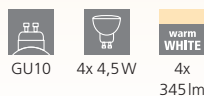

### 98858 BITACHITO

pendant light; steel, black, brass  
 Hängeleuchte; Stahl, schwarz, messing  
 luminaire en suspension; acier, noir, laiton

L 930, B 55, H 1100

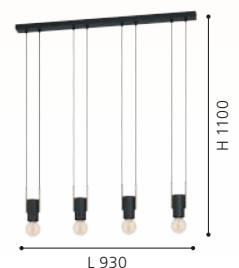



### 97604 CORTADERAS

pendant light; steel, black, gold  
 Hängeleuchte; Stahl, schwarz, gold  
 luminaire en suspension; acier, noir, or

H 1500, Ø 95

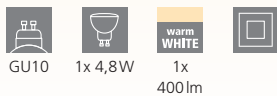

### 97605 CORTADERAS

pendant light; steel, black, gold  
 Hängeleuchte; Stahl, schwarz, gold  
 luminaire en suspension; acier, noir, or

L 1130, B 85, H 1500

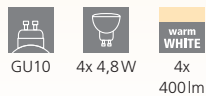

### 97606 CORTADERAS

pendant light; steel, black, gold  
 Hängeleuchte; Stahl, schwarz, gold  
 luminaire en suspension; acier, noir, or

H 1500, Ø 350

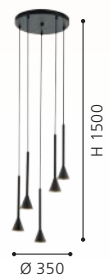
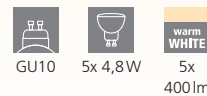





97606

LED



900401

LED



900402

LED

### 900401 SARONA

pendant light; steel, black, gold  
Hängeleuchte; Stahl, schwarz, gold  
luminaire en suspension; acier, noir, or

H 1100, Ø 210

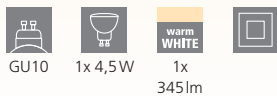

GU10 1x 4,5W 1x 345lm



### 900402 SARONA

pendant light; steel, black, gold  
Hängeleuchte; Stahl, schwarz, gold  
luminaire en suspension; acier, noir, or

L 910, B 50, H 1100



GU10 3x 4,5W 3x 345lm

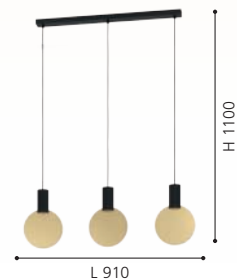



99531



99532

### 99531 LOBATIA

pendant light; steel, wood, black / terrazzo, grey, white  
 Hängeleuchte; Stahl, Holz, schwarz / Terrazzo, grau, weiss  
 luminaire en suspension; acier, bois, noir / terrazzo, gris, blanc

H 1100, Ø 105



### 99532 LOBATIA

pendant light; steel, wood, black / terrazzo, grey, white  
 Hängeleuchte; Stahl, Holz, schwarz / Terrazzo, grau, weiss  
 luminaire en suspension; acier, bois, noir / terrazzo, gris, blanc

L 925, B 55, H 1100







95522



95523

### 95522 SILVARES

pendant light; steel, grey / concrete, grey  
Hängeleuchte; Stahl, grau / Beton, grau  
luminaire en suspension; acier, gris / béton, gris

H 1100, Ø 110

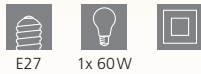

9 002759 955229



### 95523 SILVARES

pendant light; steel, grey / concrete, grey  
Hängeleuchte; Stahl, grau / Beton, grau  
luminaire en suspension; acier, gris / béton, gris

H 1500, Ø 250



9 002759 955236







95525



95526

### 95525 TAREGA

pendant light; steel, grey / wood, concrete, brown, grey  
 Hängeleuchte; Stahl, grau / Holz, Beton, braun, grau  
 luminaire en suspension; acier, gris / bois, béton, marron, gris

H 1100, Ø 150

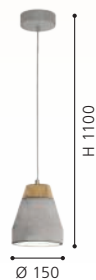

### 95526 TAREGA

pendant light; steel, grey / wood, concrete, brown, grey  
 Hängeleuchte; Stahl, grau / Holz, Beton, braun, grau  
 luminaire en suspension; acier, gris / bois, béton, marron, gris

H 1500, Ø 250





99464

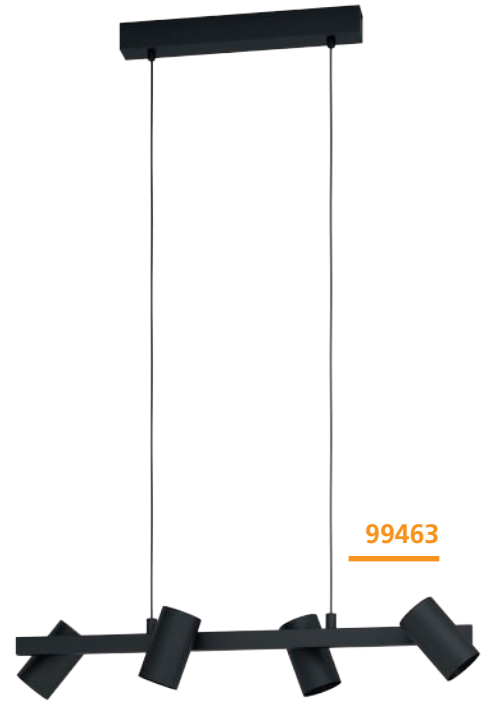

99463

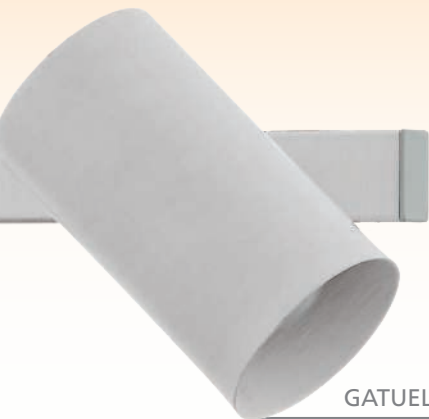

### GATUELA, GATUELA 1

The lamp heads can be swiveled.

Die Leuchtenköpfe sind schwenkbar.

Les têtes de lampe peuvent être pivotées.

### 99464 GATUELA 1

pendant light; steel, black  
Hängeleuchte; Stahl, schwarz  
luminaire en suspension; acier, noir

L 1160, B 190, H 1100



E14



6x 25W



9 002759 994648

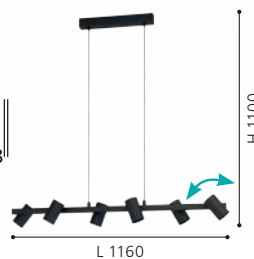

### 99463 GATUELA 1

pendant light; steel, black  
Hängeleuchte; Stahl, schwarz  
luminaire en suspension; acier, noir

L 760, B 190, H 1100



E14



4x 25W



9 002759 994631





### 98687 GATUELA

pendant light; steel, white, satin nickel  
 Hängeleuchte; Stahl, weiss, nickel-matt  
 luminaire en suspension; acier, blanc, nickel mat

L 1160, B 190, H 1100

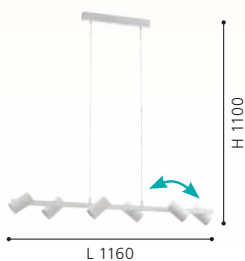

### 99819 ROVIRA

pendant light; aluminium, steel, silver / plastic, white  
 Hängeleuchte; Alu, Stahl, silber / Kunststoff, weiss  
 luminaire en suspension; aluminium, acier, argent / plastique, blanc

L 770, B 50, H 1100

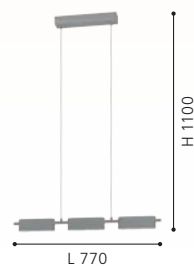

### 99821 ROVIRA

pendant light; aluminium, steel, black / plastic, white  
 Hängeleuchte; Alu, Stahl, schwarz / Kunststoff, weiss  
 luminaire en suspension; aluminium, acier, noir / plastique, blanc

L 770, B 50, H 1100

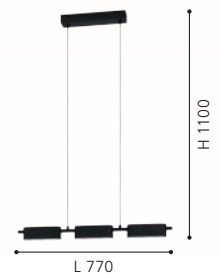

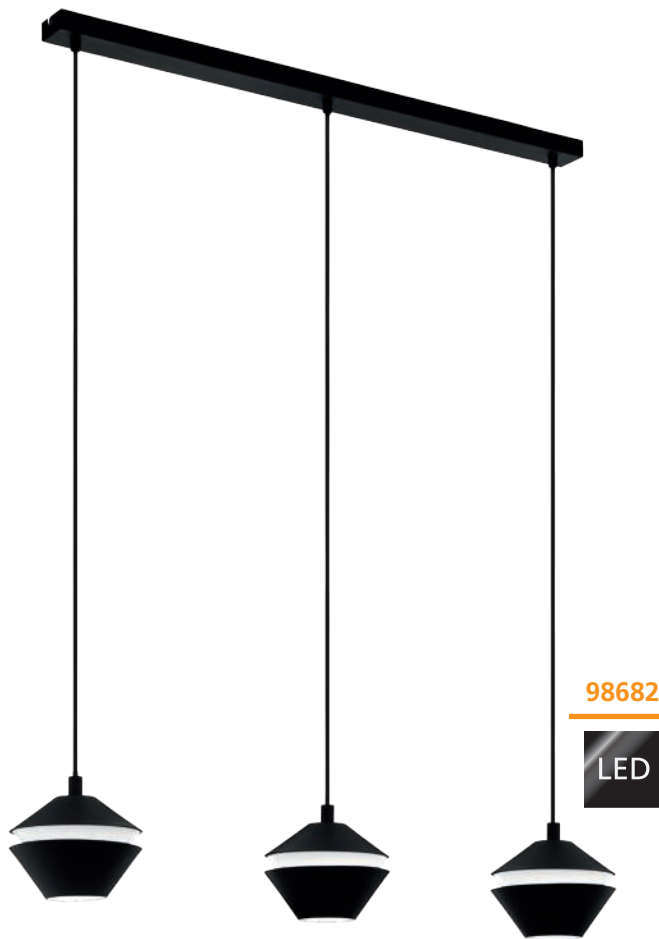

98682

LED

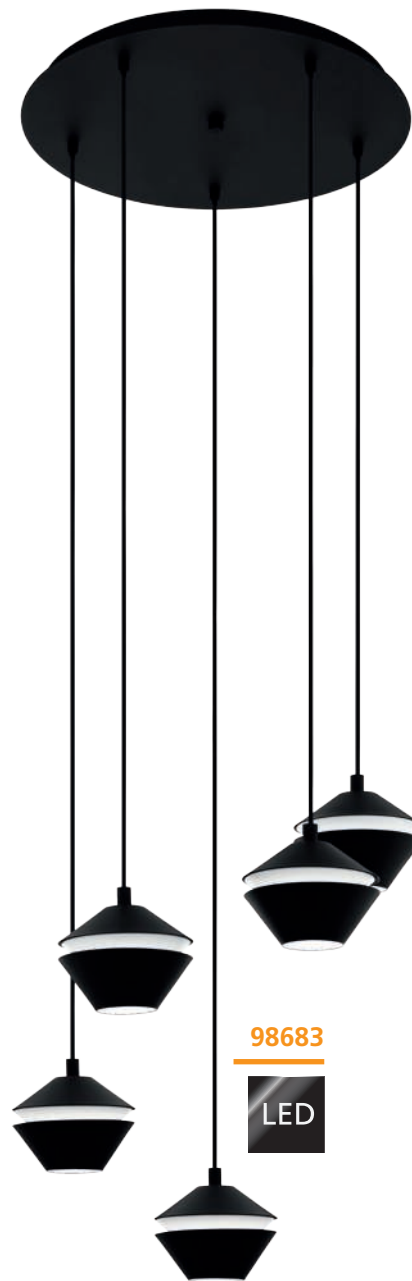

98683

LED

### 98682 PERPIGO

pendant light; steel, black / plastic, white  
 Hängeleuchte; Stahl, schwarz / Kunststoff, weiss  
 luminaire en suspension; acier, noir / plastique, blanc

L 865, B 165, H 1100

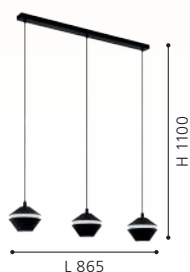
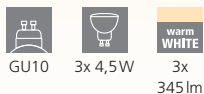

### 98683 PERPIGO

pendant light; steel, black / plastic, white  
 Hängeleuchte; Stahl, schwarz / Kunststoff, weiss  
 luminaire en suspension; acier, noir / plastique, blanc

H 1500, Ø 555



### 99013 PALBIETA

pendant light; steel, black / plastic, clear, satiné  
 Hängeleuchte; Stahl, schwarz / Kunststoff, klar, satiniert  
 luminaire en suspension; acier, noir / plastique, transparent, satiné

L 1160, B 115, H 1100







99013

LED



### 98492 AMONTILLADO

pendant light; aluminium, steel, black / plastic, white  
 Hängeleuchte; Alu, Stahl, schwarz / Kunststoff, weiss  
 luminaire en suspension; aluminium, acier, noir / plastique, blanc

L 1160, B 85, H 1100



2x 13,5W 3500lm



9 002759 984922

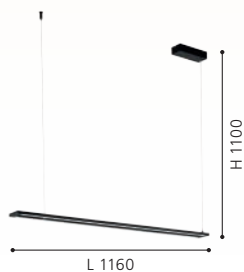

### 99599 CAMBULOS

pendant light; steel, black / plastic, white  
 Hängeleuchte; Stahl, schwarz / Kunststoff, weiss  
 luminaire en suspension; acier, noir / plastique, blanc

L 935, B 105, H 1100



2x 17W 4300lm



9 002759 995997



### 98495 SPADAFORA

pendant light; aluminium, steel, black / plastic, clear, white  
 Hängeleuchte; Alu, Stahl, schwarz / Kunststoff, klar, weiss  
 luminaire en suspension; aluminium, acier, noir / plastique, transparent, blanc

L 1160, B 80, H 1100



2x 7,5W 2000lm



9 002759 984953



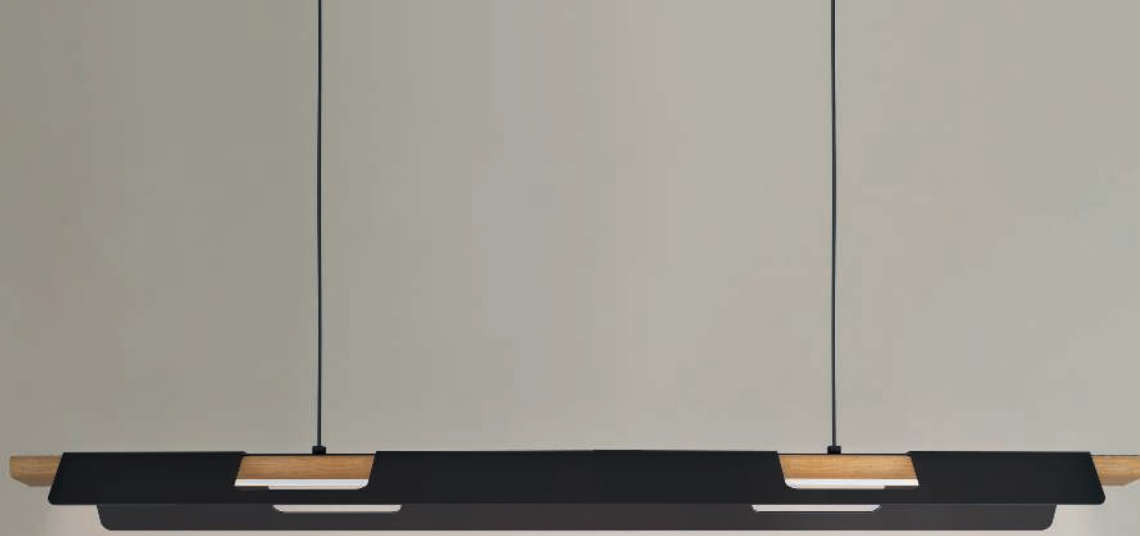

98836



### 98836 ERMUA

pendant light; steel, wood, black, brown / plastic, white  
Hängeleuchte; Stahl, Holz, schwarz, braun / Kunststoff, weiss  
luminaire en suspension; acier, bois, noir, marron / plastique, blanc

L 1000, B 165, H 1100



27W



3850lm



9 002759 988364

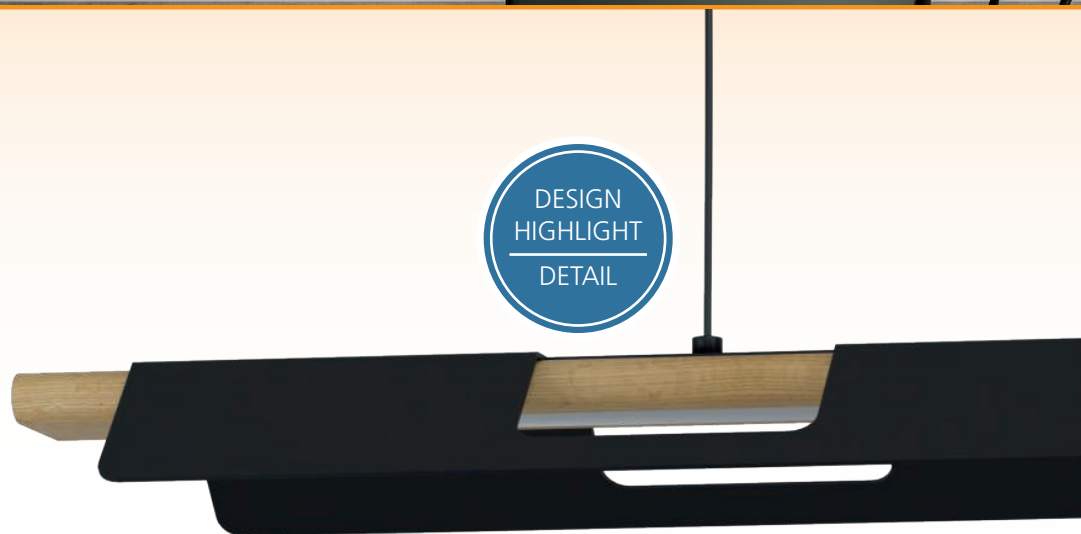



900175

LED





DESIGN  
HIGHLIGHT  
DETAIL



900174

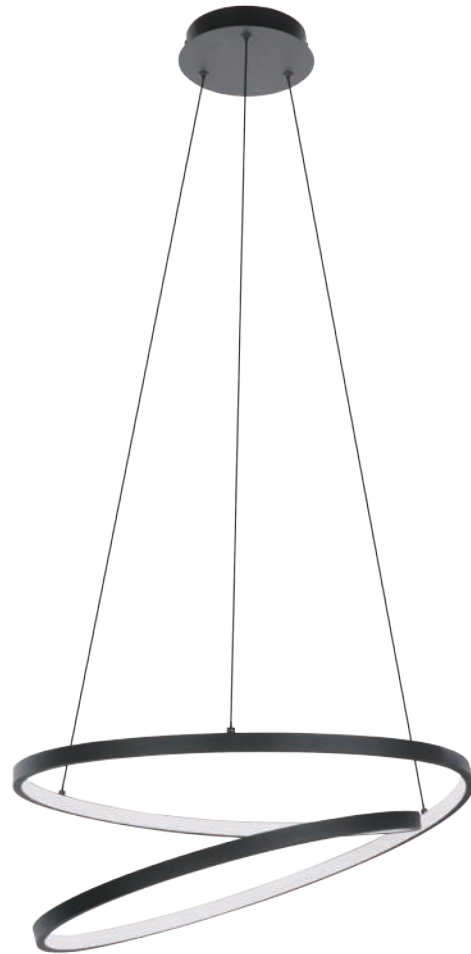

900472

LED

### 900175 LISCIANA

pendant light; aluminium, steel, wood, grey / plastic, white  
Hängeleuchte; Alu, Stahl, Holz, grau / Kunststoff, weiss  
luminaire en suspension; aluminium, acier, bois, gris / plastique, blanc

L 1260, B 35, H 1100



22W 2500lm



9 008606 238088

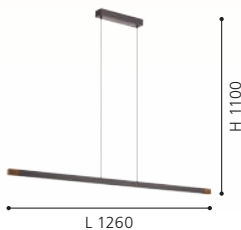

### 900174 LISCIANA

pendant light; aluminium, steel, wood, grey / plastic, white  
Hängeleuchte; Alu, Stahl, Holz, grau / Kunststoff, weiss  
luminaire en suspension; aluminium, acier, bois, gris / plastique, blanc

L 875, B 35, H 1100



18W 2000lm



9 008606 238071

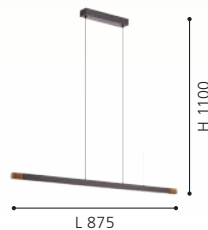

### 900472 RUOTALE

pendant light; aluminium, steel, black / plastic, white  
Hängeleuchte; Alu, Stahl, schwarz / Kunststoff, weiss  
luminaire en suspension; aluminium, acier, noir / plastique, blanc

H 1500, Ø 550



37W 4800lm



9 008606 239931

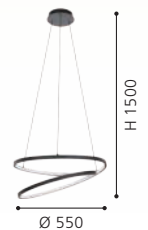



99818

LED



99249

LED

### 99818 SALITRE

pendant light; aluminium, black / plastic, white  
 Hängeleuchte; Alu, schwarz / Kunststoff, weiss  
 luminaire en suspension; aluminium, noir / plastique, blanc

H 1200, Ø 730

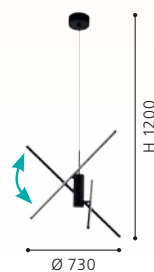

### 99249 CORREDERA

pendant light; steel, black / plastic, white  
 Hängeleuchte; Stahl, schwarz / Kunststoff, weiss  
 luminaire en suspension; acier, noir / plastique, blanc

H 1200, Ø 500

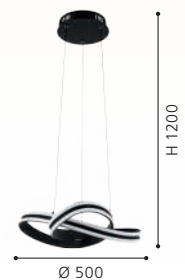

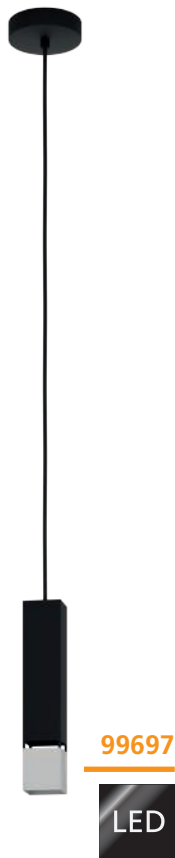

99697

LED



99698

LED

### 99697 BUTRANO

pendant light; steel, black, silver  
 Hängeleuchte; Stahl, schwarz, silber  
 luminaire en suspension; acier, noir, argent

L 55, B 55, H 1100

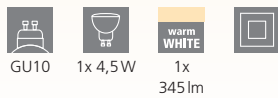

### 99698 BUTRANO

pendant light; steel, black, silver  
 Hängeleuchte; Stahl, schwarz, silber  
 luminaire en suspension; acier, noir, argent

L 770, B 55, H 1100





99073



99072



DESIGN  
HIGHLIGHT  
DETAIL

### 99073 MIRTAZZA

pendant light; steel, black / steel, champagne  
Hängeleuchte; Stahl, schwarz / Stahl, champagner  
luminaire en suspension; acier, noir / acier, champagne

H 1100, Ø 590



### 99072 MIRTAZZA

pendant light; steel, black / steel, champagne  
Hängeleuchte; Stahl, schwarz / Stahl, champagner  
luminaire en suspension; acier, noir / acier, champagne

L 880, B 180, H 1100

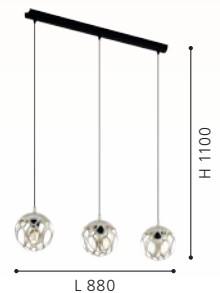





98688



98689



97066

### 98688 OKINZURI

pendant light; steel, nickel-nero  
Hängeleuchte; Stahl, nickel-nero  
luminaire en suspension; acier, nickel noir

H 1100, Ø 450



E27 1x 60W



9 002759 986889



### 98689 OKINZURI

pendant light; steel, brass  
Hängeleuchte; Stahl, messing  
luminaire en suspension; acier, laiton

H 1100, Ø 450



E27 1x 60W



9 002759 986896



### 97066 ESTEVAU

pendant light; steel, dark brown  
Hängeleuchte; Stahl, dunkelbraun  
luminaire en suspension; acier, marron foncé

L 975, B 145, H 1100



E27 4x 60W



9 002759 970666





92251

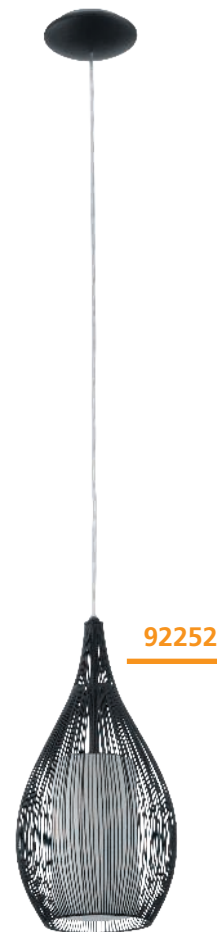

92252



RAZONI

### 92251 RAZONI

pendant light; steel, white / satin glass, steel, white  
Hängeleuchte; Stahl, weiss / Glas satiniert, Stahl, weiss  
luminaire en suspension; acier, blanc / verre satiné, acier, blanc

H 1300, Ø 190



E27



1x 60W



9 002759 922511





### 92252 RAZONI

pendant light; steel, black / satin glass, steel, black, white  
 Hängeleuchte; Stahl, schwarz / Glas satiniert, Stahl, schwarz, weiss  
 luminaire en suspension; acier, noir / verre satiné, acier, noir, blanc

H 1300, Ø 190



9 002759 922528



### 94388 RAZONI

pendant light; steel, white / satin glass, steel, white  
 Hängeleuchte; Stahl, weiss / Glas satiniert, Stahl, weiss  
 luminaire en suspension; acier, blanc / verre satiné, acier, blanc

L 990, B 190, H 1100



9 002759 943882



### 94389 RAZONI

pendant light; steel, black / satin glass, steel, black, white  
 Hängeleuchte; Stahl, schwarz / Glas satiniert, Stahl, schwarz, weiss  
 luminaire en suspension; acier, noir / verre satiné, acier, noir, blanc

L 990, B 190, H 1100



9 002759 943899





DESIGN  
HIGHLIGHT  
DETAIL



99635 | 99636

99634

99636

**99634 MASETA**

pendant light; steel, black / smoked glass, black-transparent  
Hängeleuchte; Stahl, schwarz / Rauchglas, schwarz-transparent  
luminaire en suspension; acier, noir / verre fumé, noir transparent

L 930, B 225, H 1100



**99636 MASETA**

pendant light; steel, gold-coloured / glass opal-matt, white  
Hängeleuchte; Stahl, goldfarben / Glas opal-matt, weiss  
luminaire en suspension; acier, or / verre opale mat, blanc

L 930, B 225, H 1100



**99635 MASETA**

pendant light; steel, gold-coloured / glass opal-matt, white  
Hängeleuchte; Stahl, goldfarben / Glas opal-matt, weiss  
luminaire en suspension; acier, or / verre opale mat, blanc

H 1100, Ø 225





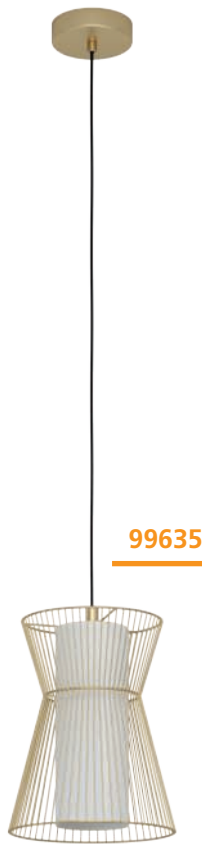

99633 | 99634

## 99633 MASETA

pendant light; steel, black / smoked glass, black-transparent  
Hängeleuchte; Stahl, schwarz / Rauchglas, schwarz-transparent  
luminaire en suspension; acier, noir / verre fumé, noir transparent

H 1100, Ø 225



E27



1x 40W

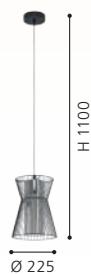



### 99705 FLORESTA

pendant light; steel, black / glass vaporized, black-transparent  
 Hängeleuchte; Stahl, schwarz / Glas bedampft, schwarz-transparent  
 luminaire en suspension; acier, noir / verre vaporisé, noir transparent

H 1100, Ø 195



### 99706 FLORESTA

pendant light; steel, black / glass vaporized, black-transparent  
 Hängeleuchte; Stahl, schwarz / Glas bedampft, schwarz-transparent  
 luminaire en suspension; acier, noir / verre vaporisé, noir transparent

L 890, B 190, H 1100



### 99707 ZOCABON

pendant light; steel, black / glass, clear  
 Hängeleuchte; Stahl, schwarz / Glas, klar  
 luminaire en suspension; acier, noir / verre, transparent

L 815, B 110, H 1100





### 99619 MULEGES

pendant light; steel, black / glass opal-matt, white  
 Hängeleuchte; Stahl, schwarz / Glas opal-matt, weiss  
 luminaire en suspension; acier, noir / verre opale mat, blanc

L 960, B 160, H 1100



### 99618 MULEGES

pendant light; steel, black / glass opal-matt, white  
 Hängeleuchte; Stahl, schwarz / Glas opal-matt, weiss  
 luminaire en suspension; acier, noir / verre opale mat, blanc

H 1100, Ø 160

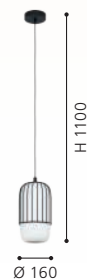



99661



99662

### 99661 CURASAO

pendant light; steel, black / steel, fabric, black, gold  
 Hängeleuchte; Stahl, schwarz / Stahl, Textil, schwarz, gold  
 luminaire en suspension; acier, noir / acier, tissu, noir, or

H 1100, Ø 335



### 99662 CURASAO

pendant light; steel, black / steel, fabric, black, gold  
 Hängeleuchte; Stahl, schwarz / Stahl, Textil, schwarz, gold  
 luminaire en suspension; acier, noir / acier, tissu, noir, or

L 995, B 235, H 1100





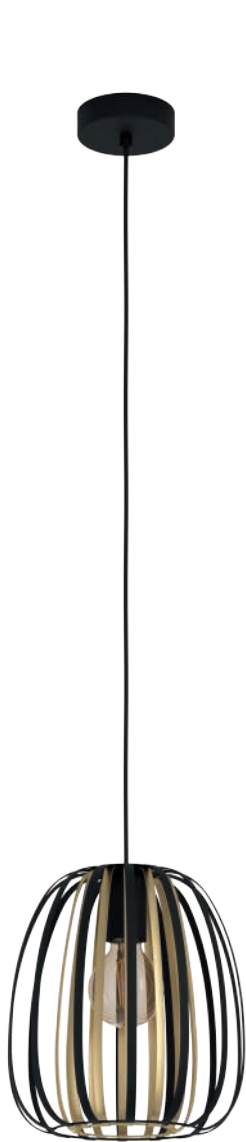

99665

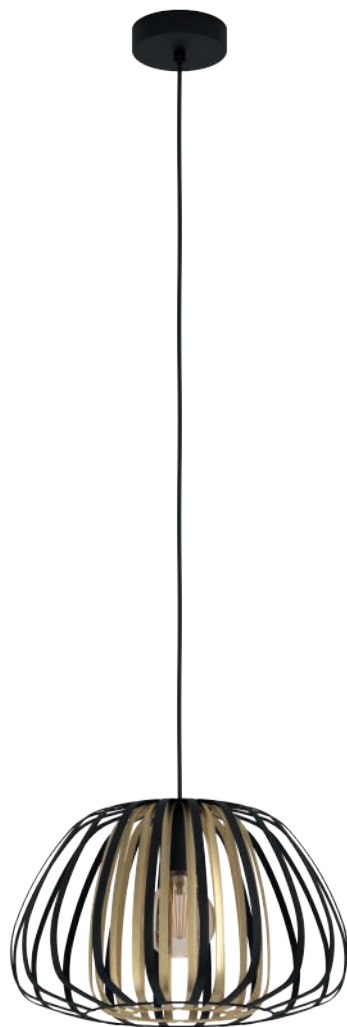

99666



### 99665 ENCINITOS

pendant light; steel, black, gold  
Hängeleuchte; Stahl, schwarz, gold  
luminaire en suspension; acier, noir, or

H 1100, Ø 255



E27 1x 40W

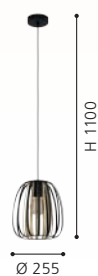

### 99666 ENCINITOS

pendant light; steel, black, gold  
Hängeleuchte; Stahl, schwarz, gold  
luminaire en suspension; acier, noir, or

H 1100, Ø 375



E27 1x 40W





99694

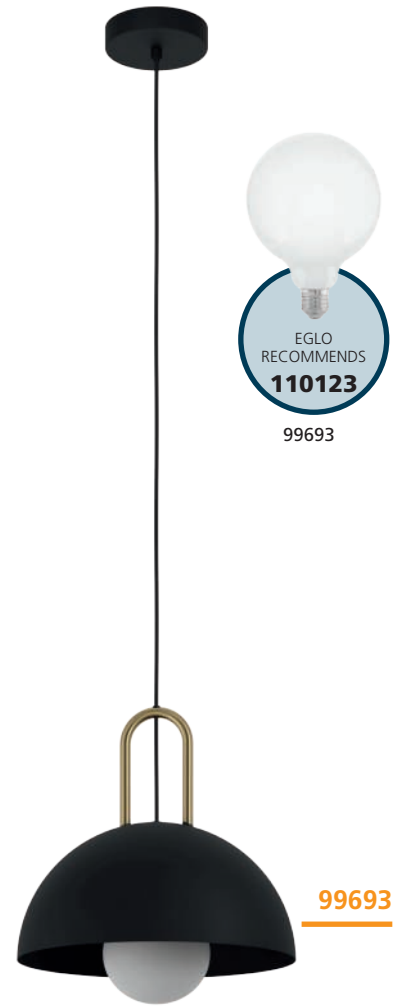

99693

99693

### 99694 CALMANERA

pendant light; steel, black, brass  
 Hängeleuchte; Stahl, schwarz, messing  
 luminaire en suspension; acier, noir, laiton

L 900, B 200, H 1100



9 002759 996949



### 99693 CALMANERA

pendant light; steel, black, brass  
 Hängeleuchte; Stahl, schwarz, messing  
 luminaire en suspension; acier, noir, laiton

H 1100, Ø 325



9 002759 996932

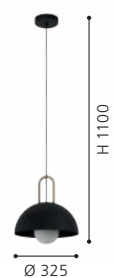

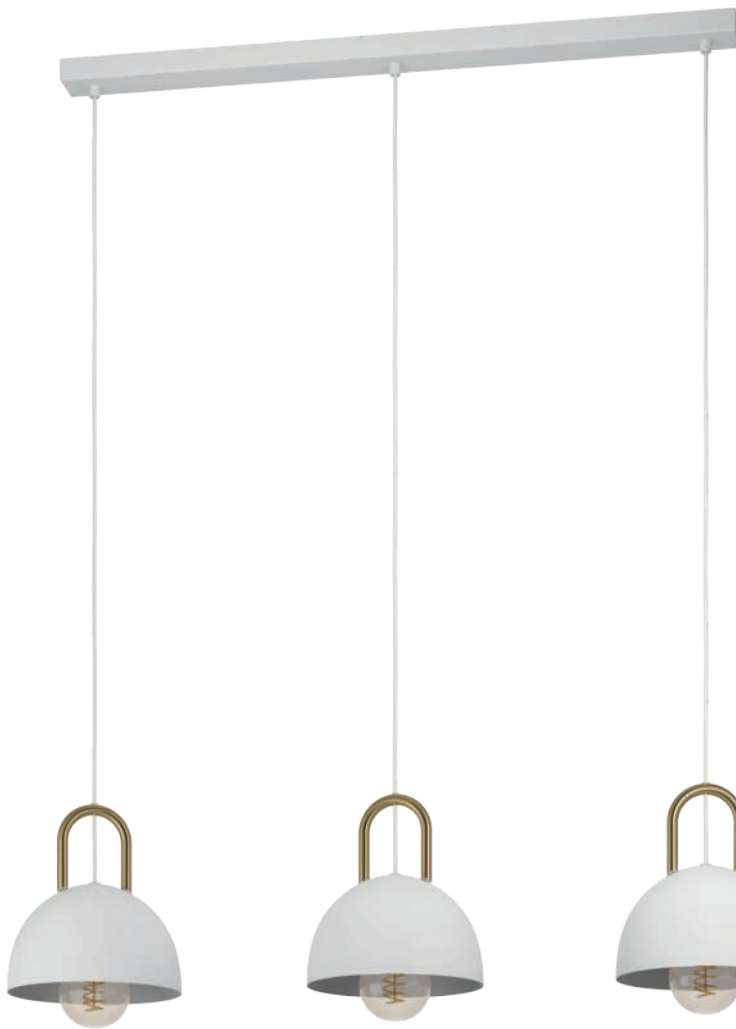

99695 | 99696

99696

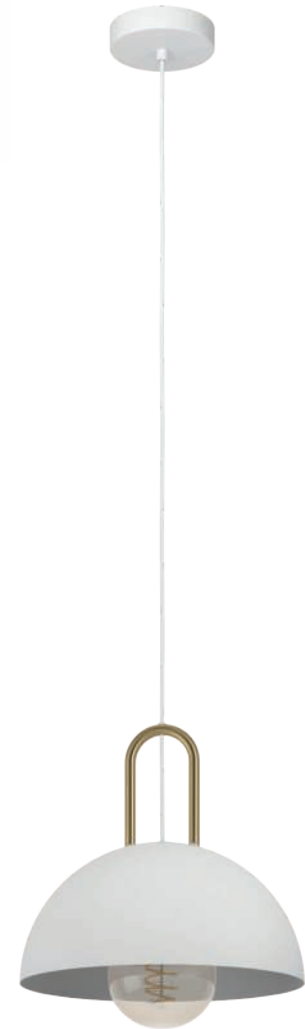

99695

### 99696 CALMANERA

pendant light; steel, white, brass  
 Hängeleuchte; Stahl, weiss, messing  
 luminaire en suspension; acier, blanc, laiton

L 900, B 200, H 1100



### 99695 CALMANERA

pendant light; steel, white, brass  
 Hängeleuchte; Stahl, weiss, messing  
 luminaire en suspension; acier, blanc, laiton

H 1100, Ø 325

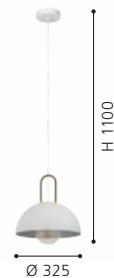



**900429**



**900431**

### 900429 VALDIOLA

pendant light; steel, sandy, brushed brass  
 Hängeleuchte; Stahl, sandfarben, messing-gebürstet  
 luminaire en suspension; acier, couleur sable, laiton brossé

H 1100, Ø 360



E27 1x 40W



9 008606 240562

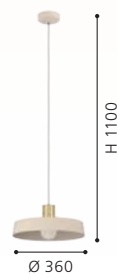

### 900431 VALDIOLA

pendant light; steel, sandy, brushed brass  
 Hängeleuchte; Stahl, sandfarben, messing-gebürstet  
 luminaire en suspension; acier, couleur sable, laiton brossé

L 930, B 230, H 1100



E27 3x 40W



9 008606 240579

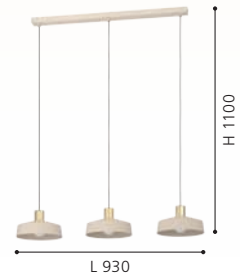





98839

LED



98838

LED

### 98839 LOSALOMAS

pendant light; steel, Mokka colour, brushed brass  
 Hängeleuchte; Stahl, Mokkafarben, messing-gebürstet  
 luminaire en suspension; acier, café, laiton brossé

L 835, B 135, H 1100



### 98838 LOSALOMAS

pendant light; steel, Mokka colour, brushed brass  
 Hängeleuchte; Stahl, Mokkafarben, messing-gebürstet  
 luminaire en suspension; acier, café, laiton brossé

H 1100, Ø 135

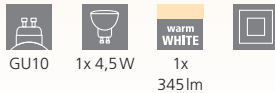



**900425**



**900426**



**900143**

### 900425 BOLIVIA

pendant light; steel, black / steel, black, sandy  
 Hängeleuchte; Stahl, schwarz / Stahl, schwarz, sandfarben  
 luminaire en suspension; acier, noir / acier, noir, couleur sable

H 1100, Ø 180



E27 1x 40W



9 008606 243853



### 900426 BOLIVIA

pendant light; steel, black / steel, black, sandy  
 Hängeleuchte; Stahl, schwarz / Stahl, schwarz, sandfarben  
 luminaire en suspension; acier, noir / acier, noir, couleur sable

L 880, B 180, H 1100



E27 3x 40W



9 008606 243860



### 900143 CAMBAITO

pendant light; steel, sandy  
 Hängeleuchte; Stahl, sandfarben  
 luminaire en suspension; acier, couleur sable

L 895, B 195, H 1100



E27 3x 40W



9 008606 238927

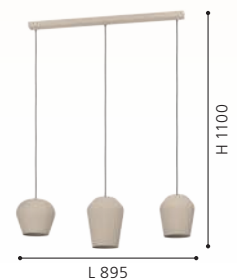

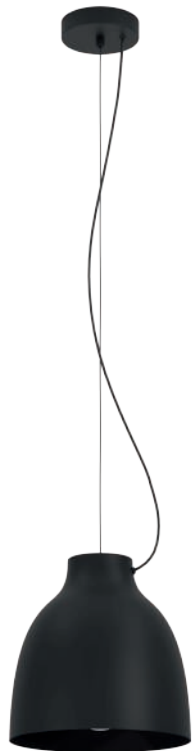

**900158**



**900159**

### 900158 CAMASCA

pendant light; steel, black  
Hängeleuchte; Stahl, schwarz  
luminaire en suspension; acier, noir

H 500 - 1100, Ø 280

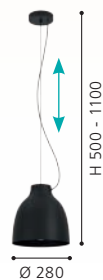

### 900159 CAMASCA

pendant light; steel, taupe  
Hängeleuchte; Stahl, taupe  
luminaire en suspension; acier, taupe

H 500 - 1100, Ø 280

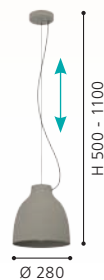

### CAMASCA

These luminaires are height adjustable.  
Diese Leuchten sind höhenverstellbar.  
Ces luminaires sont réglables en hauteur.





**900346**



**99438**



**900346 GAZZOLA**

pendant light; steel, Mokka colour, sandy  
 Hängeleuchte; Stahl, Mokka, Sandfarben  
 luminaire en suspension; acier, café, couleur sable

L 910, B 150, H 1100



E27



5x 40W



9 008606 235889

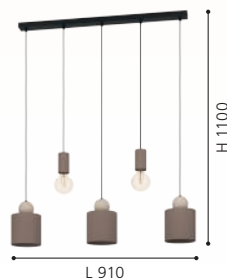

**99438 SEGEZIA**

pendant light; steel, Mokka colour / steel, Mokka colour, gold  
 Hängeleuchte; Stahl, Mokkafarben / Stahl, Mokka, gold  
 luminaire en suspension; acier, café / acier, Mokka, or

L 880, B 180, H 1100



E27



3x 40W



9 002759 994389







99439

### 99439 SEGEZIA

pendant light; steel, Mokka colour / steel, Mokka colour, gold  
Hängeleuchte; Stahl, Mokkafarben / Stahl, Mokka, gold  
luminaire en suspension; acier, café / acier, Mokka, or

H 1100, Ø 350



E27



1x 40W





**98071**

### 98071 CAMASTRA

pendant light; steel, black, gold  
Hängeleuchte; Stahl, schwarz, gold  
luminaire en suspension; acier, noir, or

H 1100, Ø 225



E27



1x 40W



9 002759 980719





98353



98456

### 98353 RAMON

pendant light; steel, black / film, white  
 Hängeleuchte; Stahl, schwarz / Folie, weiss  
 luminaire en suspension; acier, noir / film, blanc

L 860, B 160, H 1100



9 002759 983536

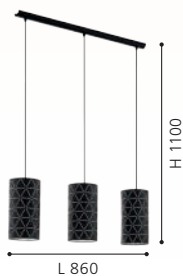

### 98456 CANTALLOPS

pendant light; steel, black, white  
 Hängeleuchte; Stahl, schwarz, weiss  
 luminaire en suspension; acier, noir, blanc

L 1150, B 520, H 1100



9 002759 984564

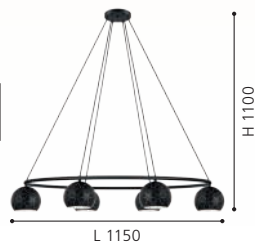



33345



97845



97841

### 33345 ROCCAFORTE

pendant light; steel, black, gold  
Hängeleuchte; Stahl, schwarz, gold  
luminaire en suspension; acier, noir, or

H 1100, Ø 170



E14 1x 40W



9 002759 333454

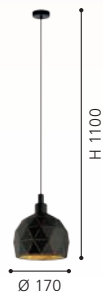

### 97845 ROCCAFORTE

pendant light; steel, black, gold  
Hängeleuchte; Stahl, schwarz, gold  
luminaire en suspension; acier, noir, or

H 1100, Ø 300



E27 1x 60W



9 002759 978457



### 97841 ROCCAFORTE

pendant light; steel, black, gold  
Hängeleuchte; Stahl, schwarz, gold  
luminaire en suspension; acier, noir, or

H 1100, Ø 400



E27 1x 60W



9 002759 978419

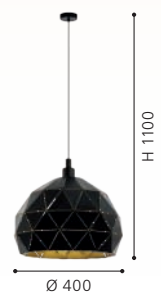





97846

### 97846 ROCCAFORTE

pendant light; steel, black, gold  
Hängeleuchte; Stahl, schwarz, gold  
luminaire en suspension; acier, noir, or

L 750, B 170, H 1100



E14



3x 40W



9 002759 978464



DESIGN  
HIGHLIGHT  
DETAIL

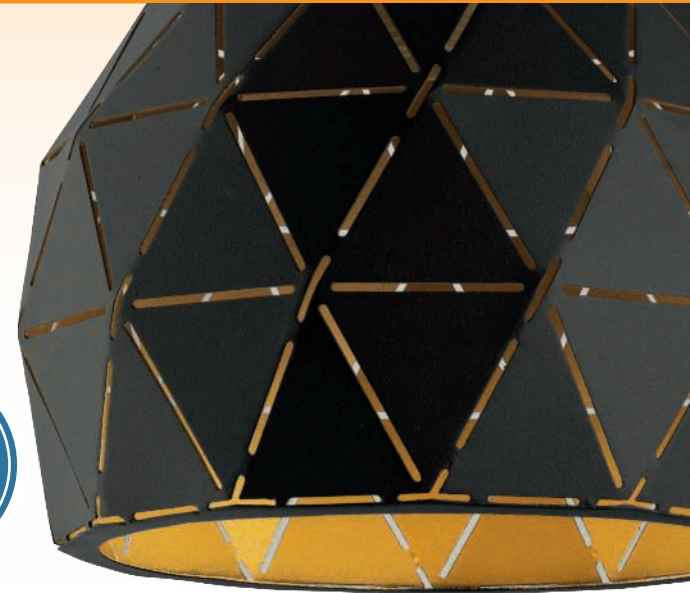



33344



97854

### 33344 ROCCAFORTE

pendant light; steel, white  
Hängeleuchte; Stahl, weiss  
luminaire en suspension; acier, blanc

H 1100, Ø 170



E14



1x 40W



9 002759 333447





97855

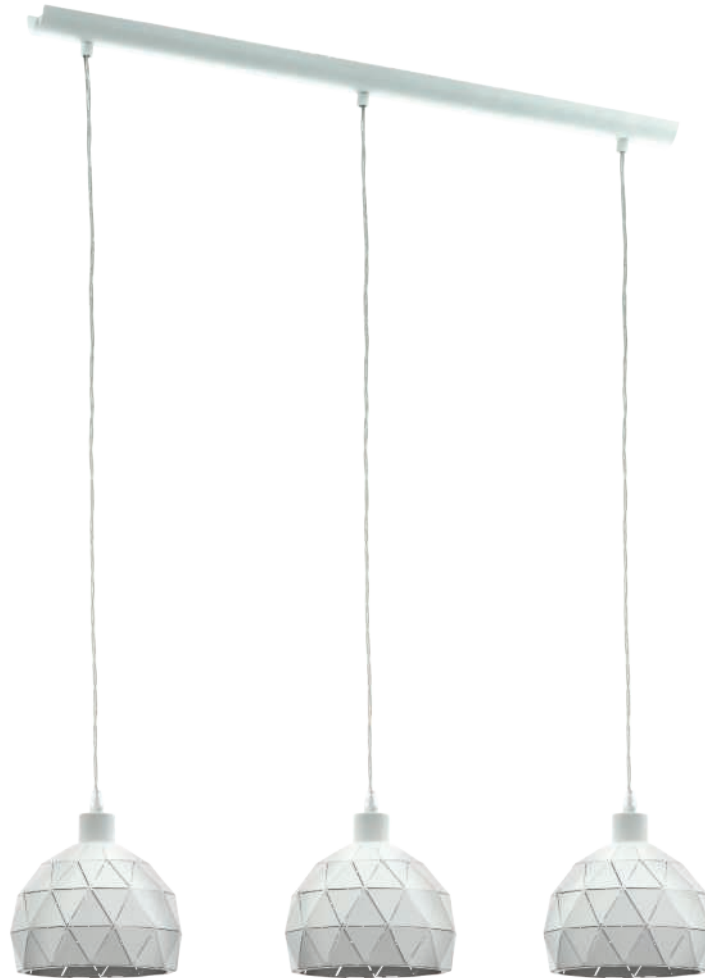

97857

### 97854 ROCCAFORTE

pendant light; steel, white  
Hängeleuchte; Stahl, weiss  
luminaire en suspension; acier, blanc

H 1100, Ø 300



9 002759 978549



### 97855 ROCCAFORTE

pendant light; steel, white  
Hängeleuchte; Stahl, weiss  
luminaire en suspension; acier, blanc

H 1100, Ø 400



9 002759 978556



### 97857 ROCCAFORTE

pendant light; steel, white  
Hängeleuchte; Stahl, weiss  
luminaire en suspension; acier, blanc

L 750, B 170, H 1100



9 002759 978570

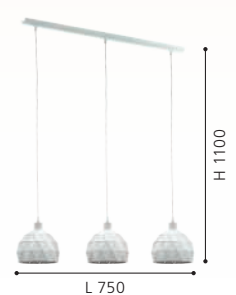





93373



93374



### 93373 CAMPILO

pendant light; plastic, white / paper threads, white  
 Hängeleuchte; Kunststoff, weiss / Papierfäden, weiss  
 luminaire en suspension; plastique, blanc / fils de papier, blanc

H 1100, Ø 450

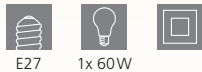

9 002759 933739



### 93374 CAMPILO

pendant light; plastic, white / paper threads, beige  
 Hängeleuchte; Kunststoff, weiss / Papierfäden, beige  
 luminaire en suspension; plastique, blanc / fils de papier, beige

H 1100, Ø 450



9 002759 933746







95385



95383

### 95385 OBREGON

pendant light; steel, brown, creme, oak  
 Hängeleuchte; Stahl, braun, creme, eiche  
 luminaire en suspension; acier, marron, crème, chêne

H 1100, Ø 350



E27 1x 60W



9 002759 953850

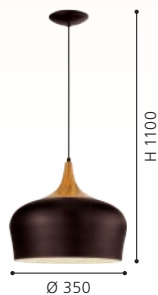

### 95383 OBREGON

pendant light; steel, creme, oak  
 Hängeleuchte; Stahl, creme, eiche  
 luminaire en suspension; acier, crème, chêne

H 1100, Ø 350



E27 1x 60W



9 002759 953836





900161

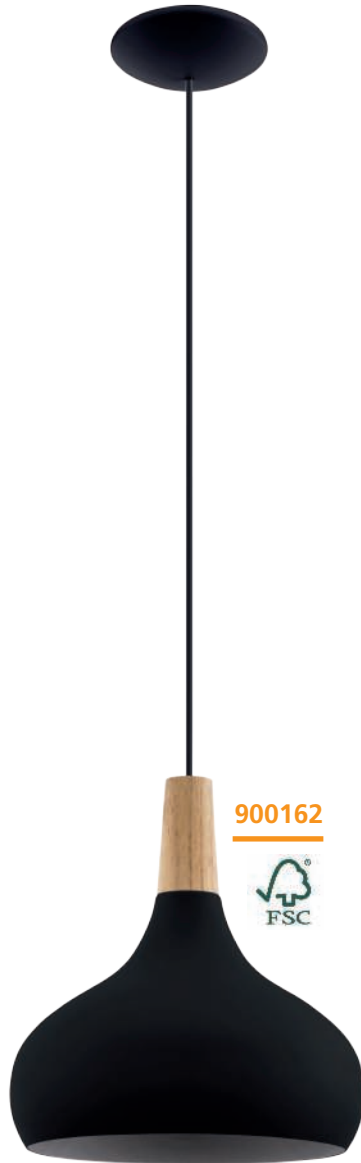

900162



900163



### 900161 SABINAR

pendant light; steel, wood, black, brown  
Hängeleuchte; Stahl, Holz, schwarz, braun  
luminaire en suspension; acier, bois, noir, marron

H 1100, Ø 180



E27



1x 40W



9 008606 235773

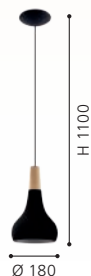

### 900162 SABINAR

pendant light; steel, wood, black, brown  
Hängeleuchte; Stahl, Holz, schwarz, braun  
luminaire en suspension; acier, bois, noir, marron

H 1100, Ø 280



E27



1x 40W



9 008606 235780



### 900163 SABINAR

pendant light; steel, wood, black, brown  
Hängeleuchte; Stahl, Holz, schwarz, braun  
luminaire en suspension; acier, bois, noir, marron

H 1100, Ø 400



E27



1x 40W



9 008606 235797

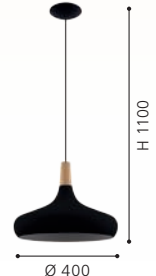



96981



96982



96983

### 96981 SABINAR

pendant light; steel, white / wood, brown  
Hängeleuchte; Stahl, weiss / Holz, braun  
luminaire en suspension; acier, blanc / bois, marron

H 1100, Ø 180

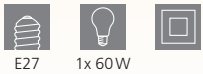

E27 1x 60W



9 002759 969813

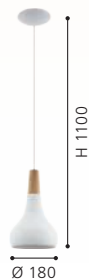

### 96982 SABINAR

pendant light; steel, white / wood, brown  
Hängeleuchte; Stahl, weiss / Holz, braun  
luminaire en suspension; acier, blanc / bois, marron

H 1100, Ø 280



E27 1x 60W



9 002759 969820

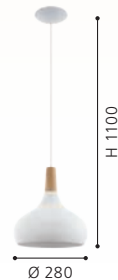

### 96983 SABINAR

pendant light; steel, white / wood, brown  
Hängeleuchte; Stahl, weiss / Holz, braun  
luminaire en suspension; acier, blanc / bois, marron

H 1100, Ø 400



E27 1x 60W



9 002759 969837





96985





96986



### 96985 SABINAR

pendant light; steel, brushed silver / wood, brown  
 Hängeleuchte; Stahl, silber gebürstet / Holz, braun  
 luminaire en suspension; acier, argent brossé / bois, marron

H 1100, Ø 280



E27 1x 60W



9 002759 969851

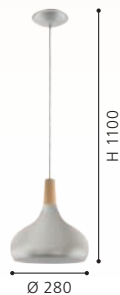

### 96986 SABINAR

pendant light; steel, brushed silver / wood, brown  
 Hängeleuchte; Stahl, silber gebürstet / Holz, braun  
 luminaire en suspension; acier, argent brossé / bois, marron

H 1100, Ø 400



E27 1x 60W



9 002759 969868





900186

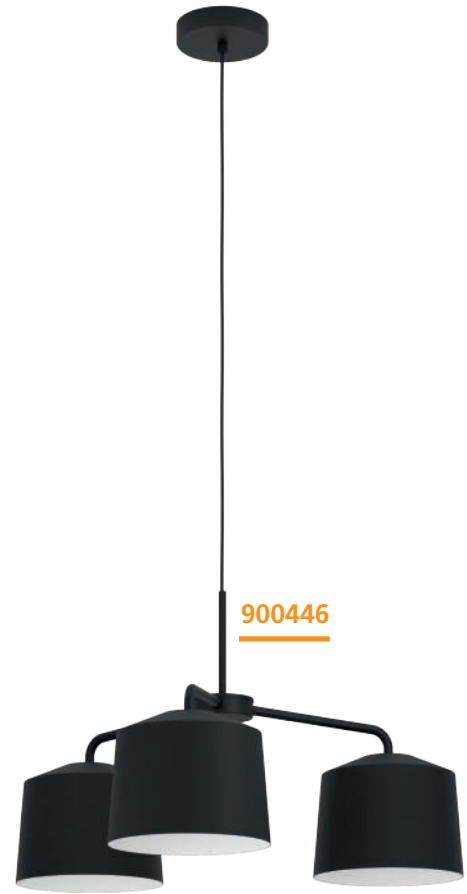

900446



### 900186 FILAGO

pendant light; steel, wood, black, brown / glass, black-grey-transparent  
 Hängeleuchte; Stahl, Holz, schwarz, braun / Glas, schwarz-grau-transparent  
 luminaire en suspension; acier, bois, noir, marron / verre, noir-gris-transparent  
 L 880, B 145, H 1100



### 900446 CAGUANES

pendant light; steel, black, white  
 Hängeleuchte; Stahl, schwarz, weiss  
 luminaire en suspension; acier, noir, blanc

H 1100, Ø 665

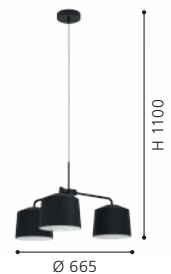



### 99702 VIGLIONI

pendant light; steel, wood, black, brown / glass vaporized, black-transparent

Hängeleuchte; Stahl, Holz, schwarz, braun / Glas bedampft, schwarz-transparent

luminaire en suspension; acier, bois, noir, marron / verre vaporisé, noir transparent

L 1060, B 165, H 1100



E27 3x 40W



9 002759 997021

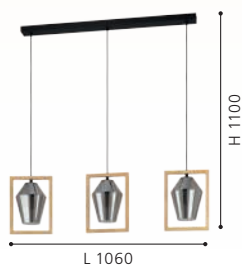

### 99701 VIGLIONI

pendant light; steel, wood, black, brown / glass vaporized, black-transparent

Hängeleuchte; Stahl, Holz, schwarz, braun / Glas bedampft, schwarz-transparent

luminaire en suspension; acier, bois, noir, marron / verre vaporisé, noir transparent

L 230, B 165, H 1100



E27 1x 40W



9 002759 997014



### 900444 TARRAFO

pendant light; steel, wood, black, brown

Hängeleuchte; Stahl, Holz, schwarz, braun

luminaire en suspension; acier, bois, noir, marron

L 880, B 150, H 1100



E27 4x 40W



9 008606 243952

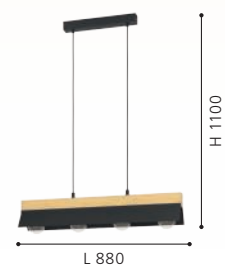

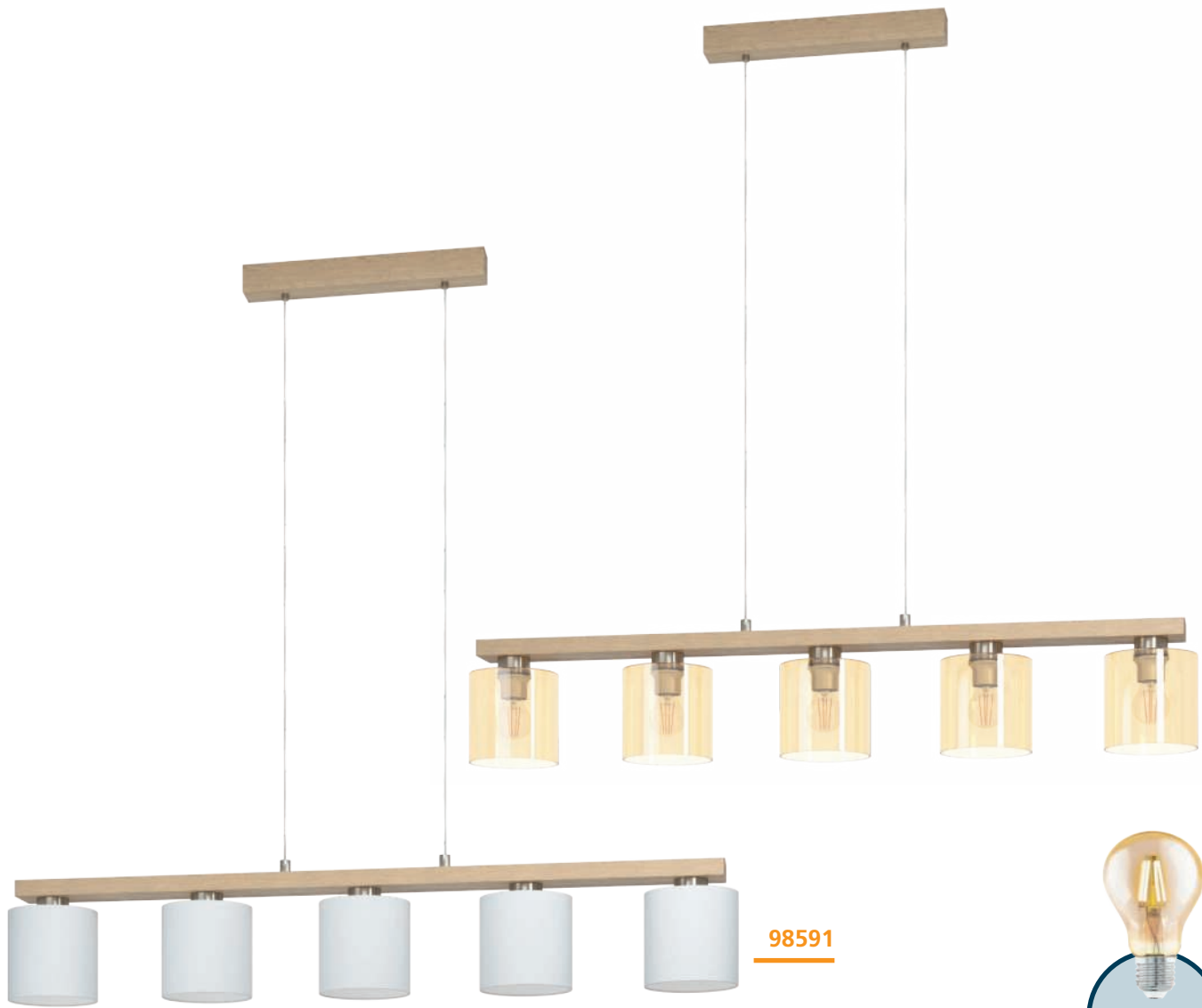

98592

98591



98592

### 98591 CASTRALVO

pendant light; steel, wood, satin nickel, brown / fabric, white  
 Hängeleuchte; Stahl, Holz, nickel-matt, braun / Textil, weiss  
 luminaire en suspension; acier, bois, nickel mat, marron / tissu, blanc

L 1210, B 150, H 1100



E27 5x 28W



9 002759 985912

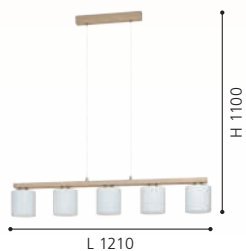

### 98592 CASTRALVO

pendant light; steel, wood, satin nickel, brown / glass vaporized, amber  
 Hängeleuchte; Stahl, Holz, nickel-matt, braun / Glas bedampft, amber  
 luminaire en suspension; acier, bois, nickel mat, marron / verre vaporisé, ambre

L 1210, B 150, H 1100



E27 5x 28W



9 002759 985929

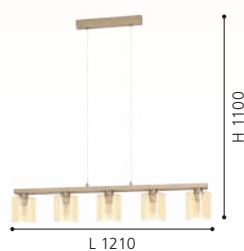

### 900313 CASTRALVO

pendant light; wood, steel, brown / fabric, black  
 Hängeleuchte; Holz, Stahl, braun / Textil, schwarz  
 luminaire en suspension; bois, acier, marron / tissu, noir

L 975, B 175, H 1100



E27 3x 40W



9 008606 235872

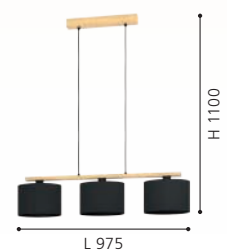



900313



## CONTRISA

The luminaire is open at the top and has a beautiful play of light.

Die Leuchte ist nach oben offen und hat ein schönes Lichtspiel.

Le luminaire est ouvert en haut et a un beau jeu de lumière.

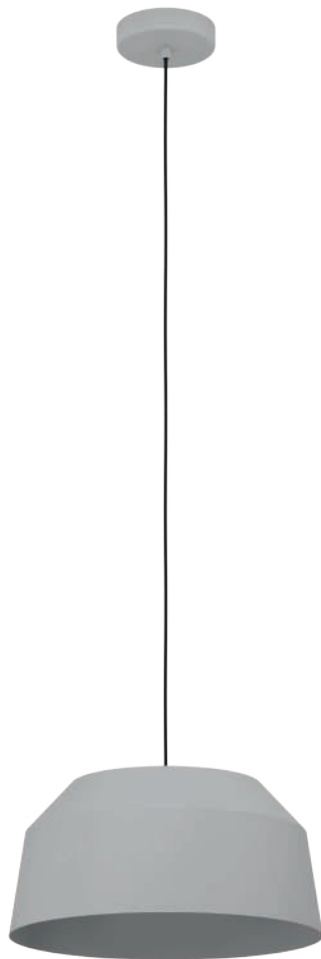

**900379**

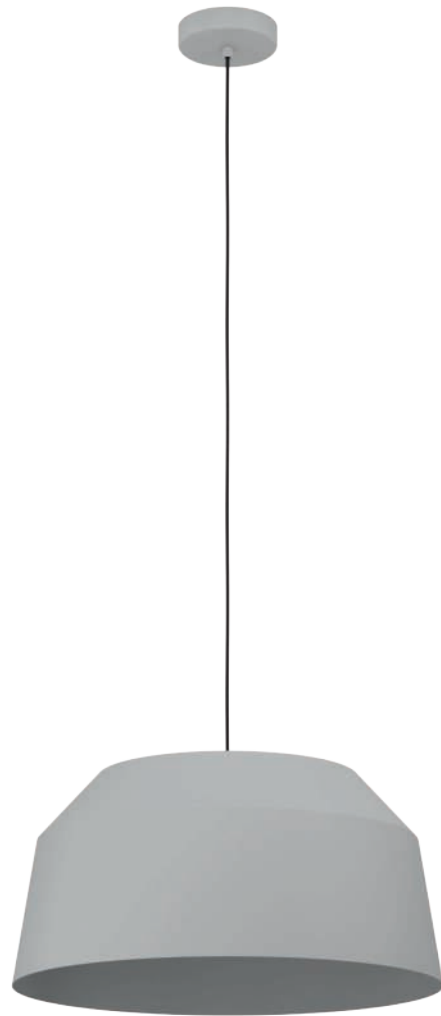

**900381**

### 900379 CONTRISA

pendant light; steel, grey  
Hängeleuchte; Stahl, grau  
luminaire en suspension; acier, gris

H 1100, Ø 380

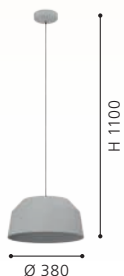

### 900381 CONTRISA

pendant light; steel, grey  
Hängeleuchte; Stahl, grau  
luminaire en suspension; acier, gris

H 1100, Ø 520



### 900362 MARIEL

pendant light; steel, wood, light grey, brown  
Hängeleuchte; Stahl, Holz, hellgrau, braun  
luminaire en suspension; acier, bois, gris clair, marron

L 910, B 190, H 1100

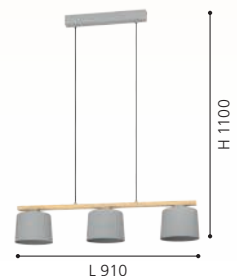



900362





**95755**



**94935**



**94936**

### 95755 NUVANO

pendant light; steel, brown, gold  
Hängeleuchte; Stahl, braun, gold  
luminaire en suspension; acier, marron, or

H 1100, Ø 480



E27 1x 60W



9 002759 957551



### 94935 GAETANO 1

pendant light; steel, black, gold  
Hängeleuchte; Stahl, schwarz, gold  
luminaire en suspension; acier, noir, or

H 1500, Ø 380



E27 1x 60W



9 002759 949358

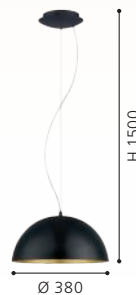

### 94936 GAETANO 1

pendant light; steel, black, gold  
Hängeleuchte; Stahl, schwarz, gold  
luminaire en suspension; acier, noir, or

H 1500, Ø 530



E27 1x 60W



9 002759 949365

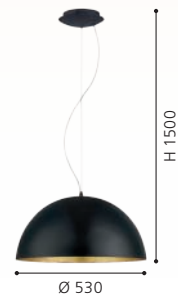





99663

LED

**99663 NUVANO**

pendant light; steel, black, gold  
 Hängeleuchte; Stahl, schwarz, gold  
 luminaire en suspension; acier, noir, or

L 985, B 225, H 1100



GU10



3x 4,5 W



3x

345 lm

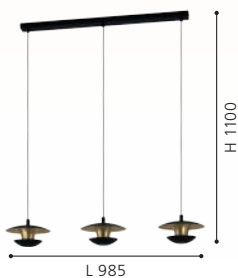



**94938**

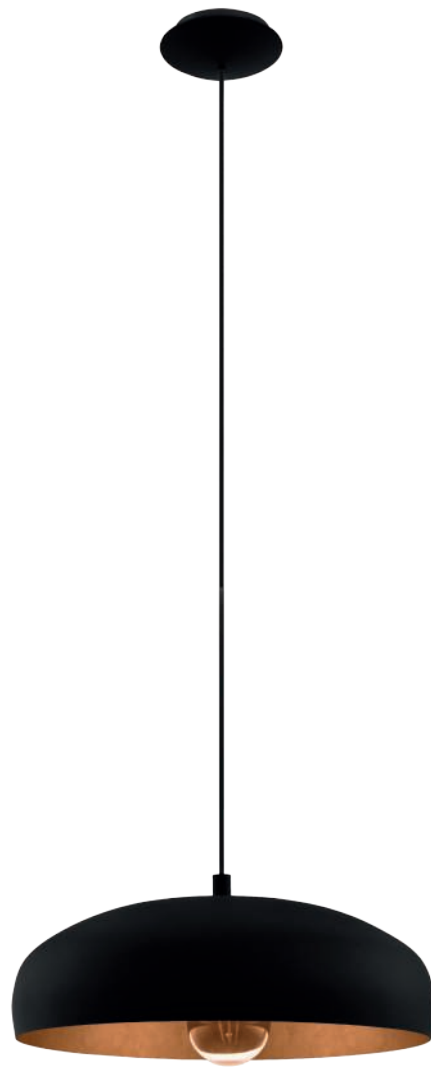

**94605**

**94938 GAETANO 1**

pendant light; steel, black, copper  
 Hängeleuchte; Stahl, schwarz, kupfer  
 luminaire en suspension; acier, noir, cuivre

H 1500, Ø 530



E27 1x 60W



9 002759 949389

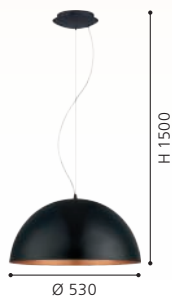

**94605 MOGANO 1**

pendant light; steel, black, copper  
 Hängeleuchte; Stahl, schwarz, kupfer  
 luminaire en suspension; acier, noir, cuivre

H 1100, Ø 400



E27 1x 60W



9 002759 946050

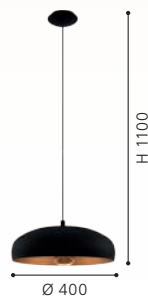

**94606 MOGANO 1**

pendant light; steel, white, copper  
 Hängeleuchte; Stahl, weiss, kupfer  
 luminaire en suspension; acier, blanc, cuivre

H 1100, Ø 400



E27 1x 60W



9 002759 946067

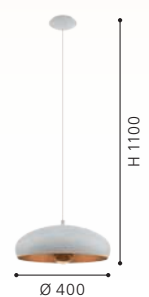





94606



98735

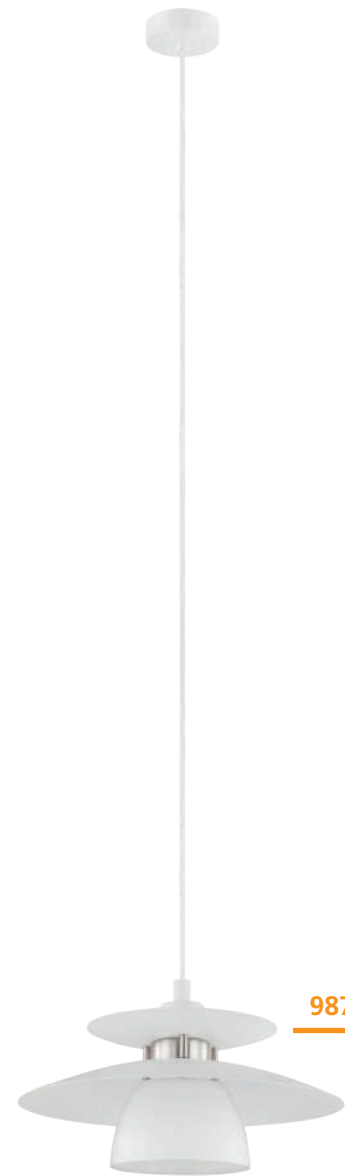

98734

### 98735 BRENDA

pendant light; steel, black, satin nickel  
 Hängeleuchte; Stahl, schwarz, nickel-matt  
 luminaire en suspension; acier, noir, nickel mat

H 1500, Ø 320



9 002759 987350



### 98734 BRENDA

pendant light; steel, white, satin nickel  
 Hängeleuchte; Stahl, weiss, nickel-matt  
 luminaire en suspension; acier, blanc, nickel mat

H 1500, Ø 320



9 002759 987343







87055



31666

### 87055 BRENDA

pendant light; plastic, steel, white, chrome / steel, white  
 Hängeleuchte; Kunststoff, Stahl, weiss, chrom / Stahl, weiss  
 luminaire en suspension; plastique, acier, blanc, chrome / acier, blanc

H 1300, Ø 430



E27 1x 60W



9 002759 870553

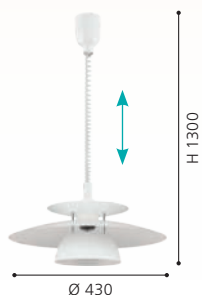

### 31666 BRENDA

pendant light; plastic, steel, black / steel, black, copper  
 Hängeleuchte; Kunststoff, Stahl, schwarz / Stahl, schwarz, kupfer  
 luminaire en suspension; plastique, acier, noir / acier, noir, cuivre

H 1100, Ø 430



E27 1x 60W



9 002759 316662

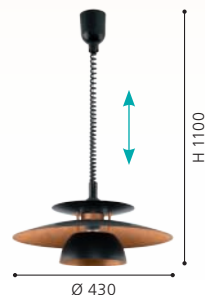

### 31666, 87055

This luminaires are flexible in height thanks to the spiral cables.

Diese Leuchten sind durch die Spiralkabel in der Höhe verstellbar.

La hauteur de ces lumières peut être ajustée à l'aide du câble en spirale.





**87054**

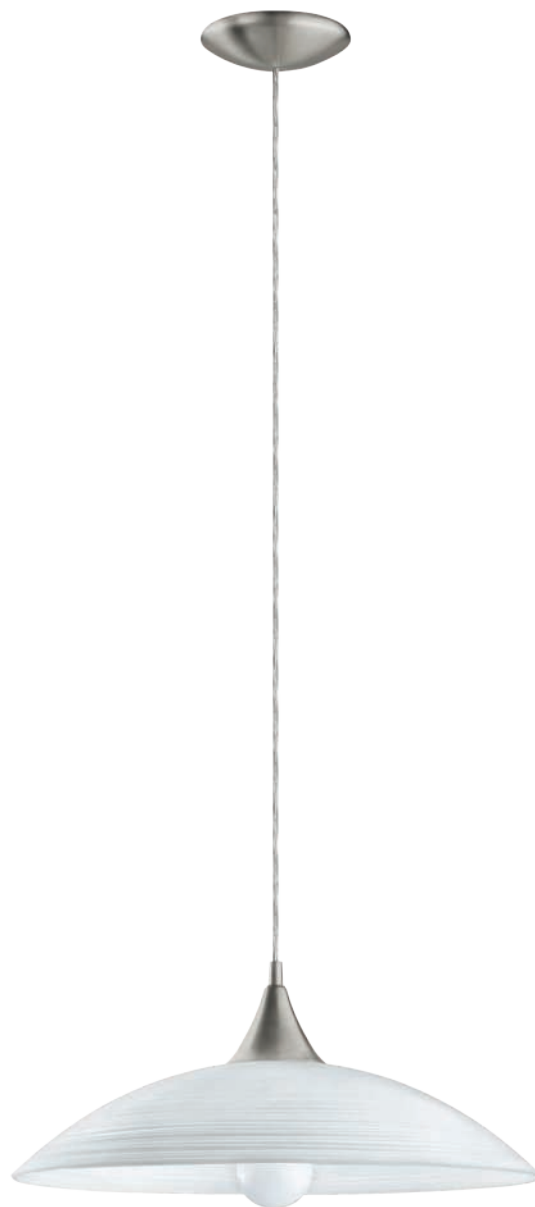

**91496**

### 87054 BRENDA

pendant light; steel, satin nickel / glass alabaster, white  
 Hängeleuchte; Stahl, nickel-matt / Glas alabaster, weiss  
 luminaire en suspension; acier, nickel mat / verre albâtre, blanc

H 1100, Ø 195



9 002759 870546



### 91496 LAZOLO

pendant light; steel, satin nickel / satin glass, white painted  
 Hängeleuchte; Stahl, nickel-matt / Glas satiniert, weiss lackiert  
 luminaire en suspension; acier, nickel mat / verre satiné, blanc laqué

H 1100, Ø 420



9 002759 914967

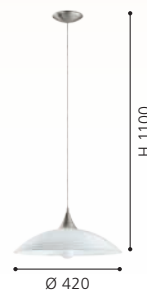

### 93468 MONTEFIO

pendant light; stainless steel, satin nickel / glass alabaster, white  
 Hängeleuchte; Edelstahl, nickel-matt / Glas alabaster, weiss  
 luminaire en suspension; acier inoxydable, nickel mat / verre albâtre, blanc

L 885, B 175, H 880 - 1300



9 002759 934682

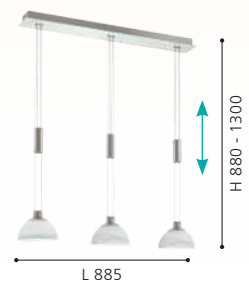



93468

LED





### 87008 LORD 2

pendant light; plastic, steel, silver, satin nickel / glass alabaster, white

Hängeleuchte; Kunststoff, Stahl, silber, nickel-matt / Glas alabaster, weiss

luminaire en suspension; plastique, acier, argent, nickel mat / verre albâtre, blanc

H 1100, Ø 360



E27 1x 60W

### 87009 LORD 2

pendant light; plastic, wood, silver, satin nickel, beech / glass alabaster, white

Hängeleuchte; Kunststoff, Holz, silber, nickel-matt, Buche / Glas alabaster, weiss

luminaire en suspension; plastique, bois, argent, nickel mat, hêtre / verre albâtre, blanc

H 1100, Ø 360



E27 1x 60W

### 3355, 87008, 87009



These luminaires are flexible in height thanks to the spiral cables.

Diese Leuchten sind durch die Spiralkabel in der Höhe verstellbar.

La hauteur de ces lumières peut être ajustée à l'aide du câble en spirale.



9 002759 870089

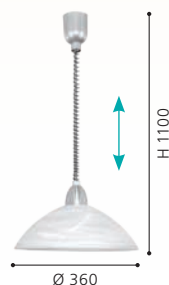

9 002759 870096

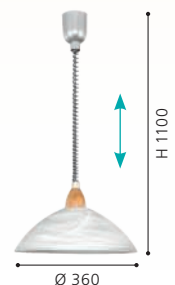





3355



90978



### 3355 ALESSANDRA

pendant light; plastic, white / glass alabaster, white  
 Hängeleuchte; Kunststoff, weiss / Glas alabaster, weiss  
 luminaire en suspension; plastique, blanc / verre albâtre, blanc

H 1100, Ø 380



E27 1x 60W



9 002759 335502

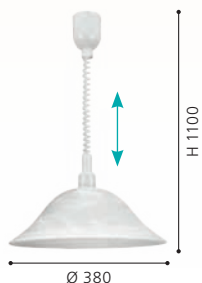

### 90978 ALBANY

pendant light; plastic, white / glass alabaster, white  
 Hängeleuchte; Kunststoff, weiss / Glas alabaster, weiss  
 luminaire en suspension; plastique, blanc / verre albâtre, blanc

H 1100, Ø 350

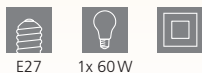

E27 1x 60W



9 002759 909789



### 3355, 87008, 87009, 90978

These luminaires come with high quality processed alabaster glass.

Diese Leuchten sind mit hochwertigem Alabasterglas ausgestattet.

Ces luminaires viennent avec un abat-jour en verre d'albâtre haut de gamme.



### 3041 VETRO

pendant light; plastic, white / satin glass, white, purple, black  
 Hängeleuchte; Kunststoff, weiss / Glas satiniert, weiss, lila, schwarz  
 luminaire en suspension; plastique, blanc / verre satiné, blanc, violet, noir

H 1100, Ø 420

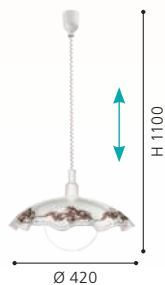

### 82786 VETRO

pendant light; plastic, white / glass, white, brown  
 Hängeleuchte; Kunststoff, weiss / Glas, weiss, braun  
 luminaire en suspension; plastique, blanc / verre, blanc, marron

H 1100, Ø 350

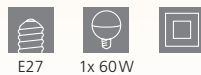

### 82785 VETRO

pendant light; plastic, white / satin glass, white  
 Hängeleuchte; Kunststoff, weiss / Glas satiniert, weiss  
 luminaire en suspension; plastique, blanc / verre satiné, blanc

H 1100, Ø 350

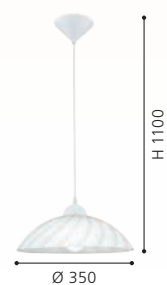



96474



96073



96072

### 3041, 96072, 96474

These luminaires are flexible in height thanks to the spiral cables.

Diese Leuchten sind durch die Spiralkabel in der Höhe verstellbar.

La hauteur de ces lumières peut être ajustée à l'aide du câble en spirale.



### 96474 ALVEZ

pendant light; plastic, white / glass with structure, white, clear  
Hängeleuchte; Kunststoff, weiss / Glas mit Struktur, weiss, klar  
luminaire en suspension; plastique, blanc / verre avec structure, blanc, transparent

H 1100, Ø 420



E27 1x 60W



9 002759 964740

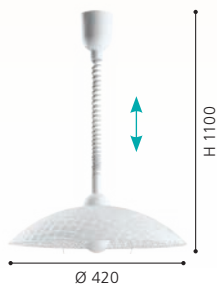

### 96073 VETRO

pendant light; plastic, white / satin glass, brilliant glass, white, clear  
Hängeleuchte; Kunststoff, weiss / Glas satiniert, Brillantglas, weiss, klar  
luminaire en suspension; plastique, blanc / verre satiné, verre brillant, blanc, transparent

H 1100, Ø 350



E27 1x 60W



9 002759 960735



### 96072 VETRO

pendant light; plastic, white / satin glass, brilliant glass, white, clear  
Hängeleuchte; Kunststoff, weiss / Glas satiniert, Brillantglas, weiss, klar  
luminaire en suspension; plastique, blanc / verre satiné, verre brillant, blanc, transparent

H 1100, Ø 415



E27 1x 60W



9 002759 960728

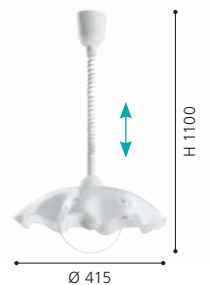

# WALL & CEILING LUMINAIRES

WAND- & DECKENLEUCHTEN  
APPLIQUES & PLAFONNIERS

## OUR ALL-ROUNDERS

The range of wall and ceiling luminaires goes from simple to unusual designs. No matter if for the entrance area, hallway or your living rooms – these luminaires give the right light.

## UNSERE ALLROUNDER

Das Sortiment an Wand- und Deckenleuchten reicht von schlichten bis hin zu ausgefallenen Designs. Egal ob für Eingangsbereich, Flur oder Ihre Wohnräume - diese Leuchten spenden das passende Licht.



## NOS PASSE-PARTOUT

La gamme d'éclairages muraux et de plafonds s'étend de designs simples à extraordinaires. Que ce soit pour l'entrée, le couloir ou vos espaces d'habitat - ces luminaires apportent la lumière appropriée.





# OVERVIEW

## WALL & CEILING LUMINAIRES

 ALTAFLOR p. 456 - 458	 MONIROTE p. 457, 459	 RUOTALE p. 460	 ULISANO p. 460	 PADULARI p. 460	 ROLIMARE p. 461	 GAFARES p. 462 - 463	 IPOLITTO p. 464
 AMONTILLADO p. 464	 SPADAFORA p. 464	 ZAMPOTE p. 465	 TIRRENARA p. 466	 MARINELLO 1 p. 466	 MARINELLO p. 467	 MIRLAS p. 468	 TAMURIA p. 470
 BORDONARA p. 472	 MARMORATA p. 473	 BOCADELLA 1 p. 474	 MUSARA p. 475	 TREMEDAL p. 475	 MESSINARO p. 476	 BELSIANA p. 476	 ENCINITOS p. 477
 BELSIANA 1 p. 477	 MONTEBALDO p. 478	 BARRANCAS p. 478	 MORDAZO p. 479	 STAITI p. 479	 SILENTINA p. 480 - 481	 MACCHIONE p. 481	 PIEDRITAS p. 482
 MOGANO p. 484 - 485	 MOGANO 2 p. 487	 VALCASOTTO p. 488, 538	 VALCASOTTO 1 p. 489	 TARRAFO p. 489	 BASURTU p. 490	 LORETO p. 491	 LORETO 1 p. 491
 MARIEL p. 493	 FILAGO p. 493	 MAROJALES p. 493	 CABO p. 494	 CONDRADE 1 p. 494	 CLEMENTE p. 496	 ACOLLA 1 p. 497	 ACOLLA p. 497
 CARDITO p. 497	 FRADELO 1 p. 498 - 499	 FRADELO p. 500 - 502	 SORRENTA 1 p. 503	 VALLEMARE p. 503	 CANICOSA 2 p. 504	 MONTENOVO p. 505	 POZONDON p. 505

							
GIRON p. 506	GIRON-S p. 507	FRANIA p. 508-509, 512-513	FRANIA-S p. 510-511, 514-515	ZAMUDILO p. 516	SILERAS p. 516-517	RUIDERA p. 517	CAPASSO 1 p. 518
							
VOLTAGO 2 p. 518	LANCIANO p. 520-521	LANCIANO 1 p. 520-521	FERENTINO p. 522-523	BATTISTONA p. 524	BENARIBA p. 525	COMPETA 1 p. 527-528	PALERMO 2 p. 529
							
CAPASSO p. 530	RENDE p. 531	NIEVES 1 p. 532	NIEVES p. 533	PESCAITO p. 534	MUSURITA p. 534-535	LAURITO p. 536	SELUCI p. 536-537
							
LUPPINERIA p. 539	PENJAMO p. 540	CALAGRANO p. 541	MENTALURGIA p. 542	REDUCTA 2 p. 543	ELLA p. 544	DURELO p. 545	PLANET p. 546
							
PLANET 1 p. 546-549	MARGITTA 1 p. 551, 554	MARS 1 p. 552-553	MARS p. 553, 558	SCALEA 1 p. 554	RAYA p. 554	GRAFIK p. 556	NEMO p. 556
							
SALOME p. 558-559	MESTRE p. 560-561	IMPERIAL p. 560	ALMERA p. 561	PASCAL 1 p. 561	CAMPANIA p. 562	GERBERA 1 p. 562	COLTI p. 562
							
SAN PERI p. 564	STAITI 1 p. 564	TAZZOLI p. 567	CIGLIE p. 567	CARTIGNANO p. 568	CIVITATE p. 569	TIMPAROSSA p. 570	GURARE p. 571

 This product is available in different colors and shapes./ Dieser Artikel ist in unterschiedlichen Farben und Formen verfügbar.  
Cet article est disponible en différentes couleurs et formes.

# OVERVIEW

## WALL & CEILING LUMINAIRES

							
ZINACUA p.571	ZUBIALDE p.572-573	ONO 2 p.573	MACCACARI p.574	FELONICHE p.575	SANIA 4 p.576-577	PASSA p.578-581	GASCUERIA p.582
							
ELIZONDO p.582	FALICETTO p.582	HAYES p.583	TANURA p.584	GUANAL p.584	MONGODIO 1 p.586	ELGVERO p.587	CADEGAL p.588-589
							
REMIDOS p.589	METRASS p.590	METRASS 2 p.591	METRASS 1 p.593	SARGINTO p.594-595			



This product is available in different colors and shapes./ Dieser Artikel ist in unterschiedlichen Farben und Formen verfügbar.  
Cet article est disponible en différentes couleurs et formes.





# FUNCTIONAL OVERVIEW

## FUNKTIONSÜBERSICHT

## PRÉSENTATION FONCTIONNELLE

The listed boxes inform you about the respective functions of our wall and ceiling luminaires. You will find them on the catalogue pages next to the product illustrations. The coloured symbol area indicates the special characteristics of the respective luminaire/luminaire family, e.g. dimming function. In the grey area below you will find detailed information on this function, e.g. dimmable from 10% - 100%.

For luminaires that come with a remote control, you can control the respective functions with the remote control. For luminaires without remote control, the functions can be switched directly on the wall switch.

Die angeführten Boxen informieren Sie über die jeweiligen Funktionen unserer Wand- und Deckenleuchten. Sie finden sie auf den Katalogseiten jeweils neben den Produktabbildungen. Der farbige Symbolbereich weist darauf hin, welche besonderen Eigenschaften die jeweilige Leuchte/Leuchtenfamilie bietet, z.B. Dimmfunktion. Im grauen Bereich darunter finden Sie detaillierte Angaben zu dieser Funktion, z.B. dimmbar von 10% - 100%.

Ist eine Fernbedienung im Lieferumfang enthalten, können Sie die jeweiligen Funktionen mit der Fernbedienung steuern. Bei Leuchten ohne Fernbedienung können die Funktionen direkt am Wandschalter geschaltet werden.

Les boîtes de dialogue présentes vous informent sur les fonctions respectives de nos appliques et plafonniers. Vous les trouverez sur les pages du catalogue à côté des illustrations des produits. La zone colorée des symboles indique les caractéristiques particulières de chaque luminaire/famille de luminaires, par ex. la fonction de gradation. Dans la zone grise ci-dessous, vous trouverez des informations détaillées sur cette fonction, par ex. graduable de 10% - 100%.

Pour les luminaires équipés d'une télécommande, vous pouvez commander les fonctions correspondantes à l'aide de la télécommande. Pour les luminaires sans télécommande, les fonctions peuvent être commutées directement sur l'interrupteur mural.



**DIMMABLE**

e.g./z.B./par ex.  
10 - 100%

The brightness of the luminaire can be steplessly controlled.

Die Helligkeit der Leuchte kann stufenlos im angegebenen Bereich gesteuert werden.

La luminosité du luminaire peut être réglée en continu.



**STEP DIMMING**

e.g./z.B./par ex.  
10%/50%/100%

The brightness of the luminaire can be controlled step by step.

Die Helligkeit der Leuchte kann schrittweise gesteuert werden.

La luminosité du luminaire peut être réglée pas à pas.



**TUNABLE WHITE**

e.g./z.B./par ex.  
2700 - 6500 K

The colour temperature can be controlled from warm to cold white LED light.

Die Farbtemperatur kann von warm- bis kaltweißem LED-Licht gesteuert werden.

La température de couleur peut être réglée de la lumière DEL blanche chaude à la lumière DEL blanche froide.



**STEP TUNABLE**

e.g./z.B./par ex.  
3000/4000/5000 K

The colour temperature of warm to cold white LED light can be changed directly on the wall switch in 3 preset steps.

Die Farbtemperatur von warm- bis kaltweißem LED-Licht kann direkt am Wandschalter in 3 voreingestellten Schritten verändert werden.

La température de couleur peut être modifiée de la lumière DEL blanche chaude à la lumière DEL blanche froide directement sur l'interrupteur mural en 3 étapes prédéfinies.



**NIGHT LIGHT FUNCTION**

Luminaires can be switched to a night light mode. With included remote control or, for luminaires without remote control, via wall switch (ambient light).

Leuchten können auf einen Nacht-Licht-Modus umgeschaltet werden. Mit inkludierter Fernbedienung oder bei Leuchten ohne Fernbedienung per Wandschalter (Ambient light).

Les luminaires peuvent être commutés en mode veilleuse. Avec télécommande incluse ou, pour les luminaires sans télécommande, via interrupteur mural (lumière ambiante).



**TIMER FUNCTION**

e.g./z.B./par ex.  
off after 30 sec.

The luminaire switches itself off after a preset time.

Die Leuchte schaltet sich nach einer voreingestellten Zeit selbst aus.

La lumière s'éteint d'elle-même après une durée prédéfinie.







99788

LED

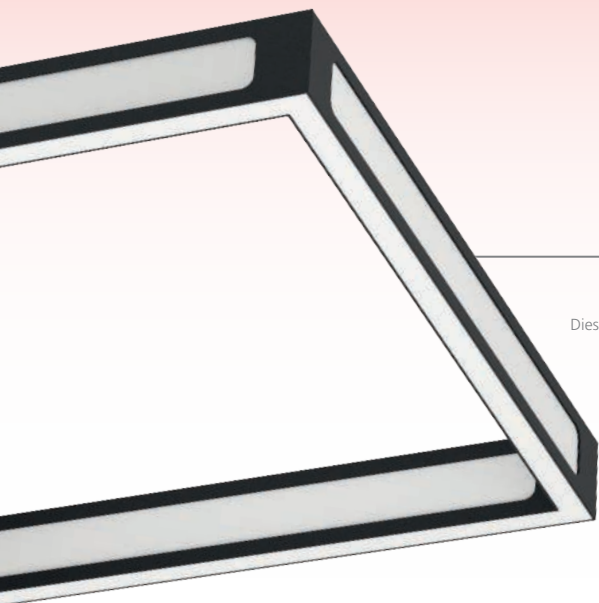

### ALTAFLOR

These luminaires have an additional glow on the inside.

Diese Leuchten haben einen zusätzlichen Lichtschein nach Innen.

Ces luminaires ont une lueur supplémentaire à l'intérieur.

### 99788 ALTAFLOR

ceiling light; steel, black / plastic, white  
Deckenleuchte; Stahl, schwarz / Kunststoff, weiss  
plafonnier; acier, noir / plastique, blanc

L 650, B 300, H 70

LED

8x 2,8W

warm  
WHITE

3040lm



9 002759 997885

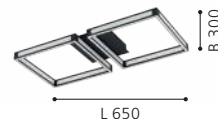



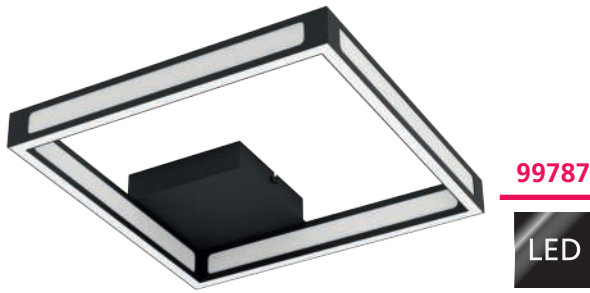

99787



99789

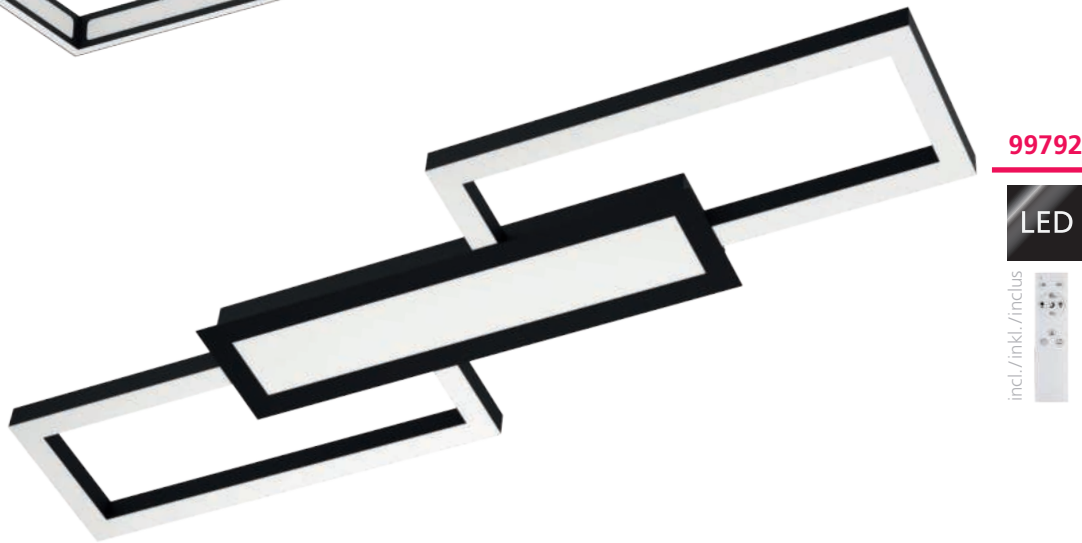

99792



### 99787 ALTAFLOR

ceiling light; steel, black / plastic, white  
Deckenleuchte; Stahl, schwarz / Kunststoff, weiss  
plafonnier; acier, noir / plastique, blanc

L 315, B 315, H 70



4x 2,8W 1520lm

### 99789 ALTAFLOR

ceiling light; steel, black / plastic, white  
Deckenleuchte; Stahl, schwarz / Kunststoff, weiss  
plafonnier; acier, noir / plastique, blanc

L 1000, B 315, H 70



12x 2,8W 4560lm

### 99792 MONIROTE

ceiling light; steel, aluminium, black / plastic, white  
Deckenleuchte; Stahl, Alu, schwarz / Kunststoff, weiss  
plafonnier; acier, aluminium, noir / plastique, blanc

L 780, H 45



37W 4450lm



9 002759 997878

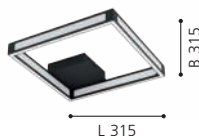

9 002759 997892

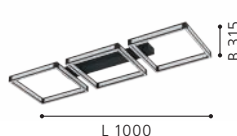

9 002759 997922

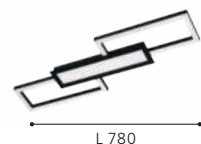



99784

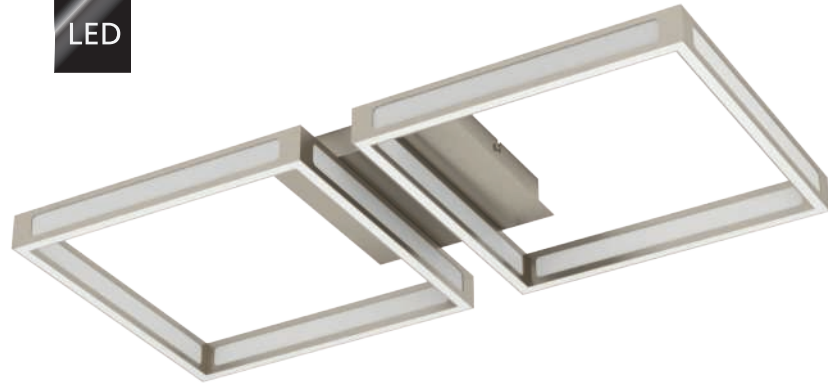

99785

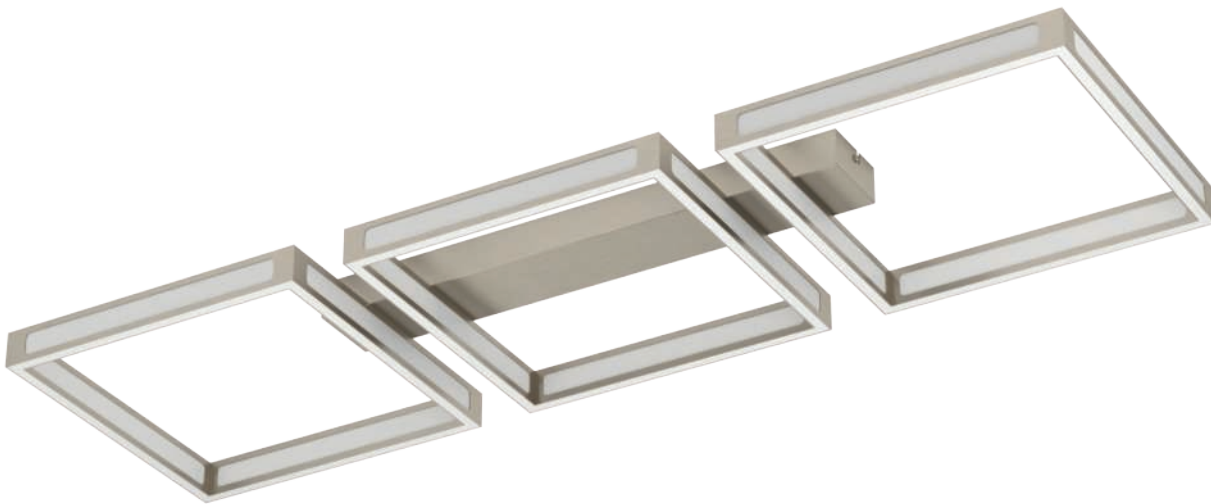

99786



### 99784 ALTAFLOR

ceiling light; steel, satin nickel / plastic, white  
Deckenleuchte; Stahl, nickel-matt / Kunststoff, weiss  
plafonnier; acier, nickel mat / plastique, blanc

L 315, B 315, H 70



4x 2,8W 1520lm

### 99785 ALTAFLOR

ceiling light; steel, satin nickel / plastic, white  
Deckenleuchte; Stahl, nickel-matt / Kunststoff, weiss  
plafonnier; acier, nickel mat / plastique, blanc

L 650, B 300, H 70



8x 2,8W 3040lm

### 99786 ALTAFLOR

ceiling light; steel, satin nickel / plastic, white  
Deckenleuchte; Stahl, nickel-matt / Kunststoff, weiss  
plafonnier; acier, nickel mat / plastique, blanc

L 1000, B 315, H 70



12x 2,8W 4560lm



9 002759 997847

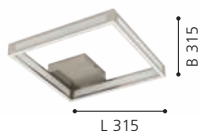

9 002759 997854

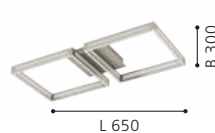

9 002759 997861

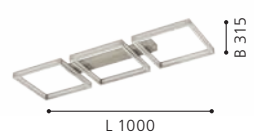



99791

LED

incl./inkl./inclus



### 99791 MONIROTE

ceiling light; steel, aluminium, satin nickel / plastic, white  
 Deckenleuchte; Stahl, Alu, nickel-matt / Kunststoff, weiss  
 plafonnier; acier, aluminium, nickel mat / plastique, blanc

L 780, B 260, H 45



37W



4450lm



Remote

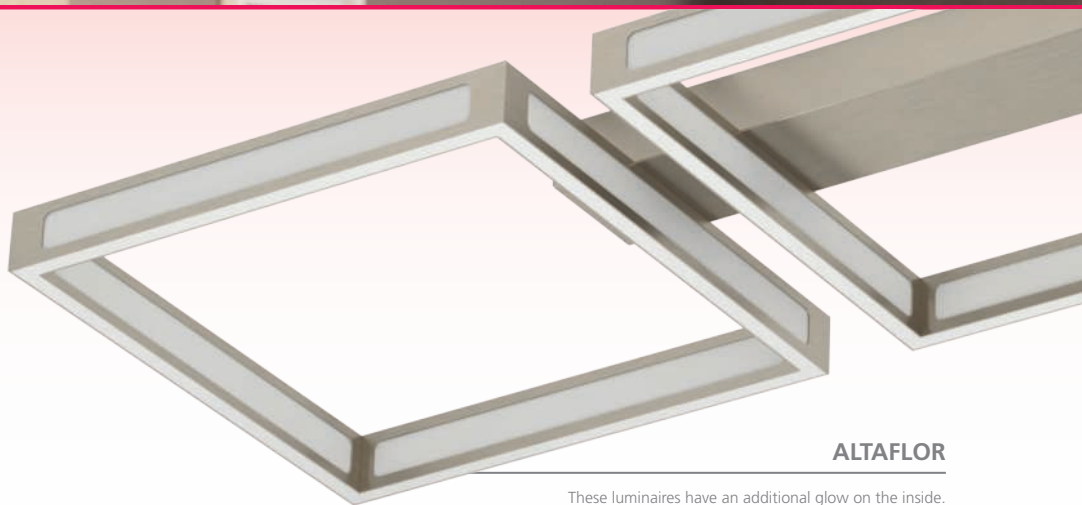

### ALTAFLOR

These luminaires have an additional glow on the inside.

Diese Leuchten haben einen zusätzlichen Lichtschein nach Innen.

Ces luminaires ont une lueur supplémentaire à l'intérieur.



9 002759 997915



L 780



900471

LED



900596

LED

incl./inkl./inclus

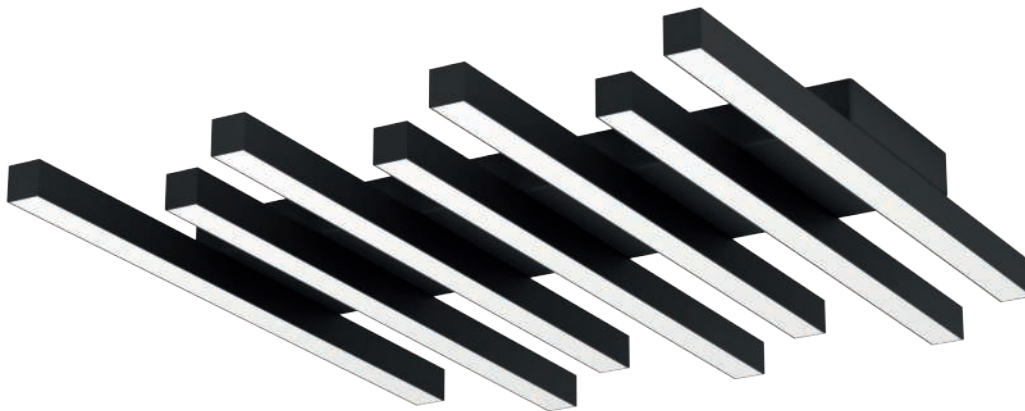

900597

LED

incl./inkl./inclus



### 900471 RUOTALE

ceiling light; aluminium, steel, black / plastic, white  
Deckenleuchte; Alu, Stahl, schwarz / Kunststoff, weiss  
plafonnier; aluminium, acier, noir / plastique, blanc

H 55, Ø 450



36W



4400lm



### 900596 ULISANO

ceiling light; aluminium, steel, black / plastic, white  
Deckenleuchte; Alu, Stahl, schwarz / Kunststoff, weiss  
plafonnier; aluminium, acier, noir / plastique, blanc

L 420, B 420, H 55



21W



3000lm



### 900597 PADULARI

ceiling light; aluminium, steel, black / plastic, white  
Deckenleuchte; Alu, Stahl, schwarz / Kunststoff, weiss  
plafonnier; aluminium, acier, noir / plastique, blanc

L 535, B 470, H 50



25,6W



3800lm



Remote



9 008606 244096



9 008606 244959



9 008606 244966







900419

LED



99395

LED



### 900419 ROLIMARE

ceiling light; aluminium, satin nickel / plastic, white  
Deckenleuchte; Alu, nickel-matt / Kunststoff, weiss  
plafonnier; aluminium, nickel mat / plastique, blanc

L 420, B 400, H 130

LED

35W

neutral  
WHITE

5500lm



### 99395 ROLIMARE

ceiling light; aluminium, black / plastic, white  
Deckenleuchte; Alu, schwarz / Kunststoff, weiss  
plafonnier; aluminium, noir / plastique, blanc

L 420, B 400, H 130

LED

35W

neutral  
WHITE

5500lm



9 008606 240999



L 420

H 130



9 002759 993955



L 420

H 130

DESIGN  
HIGHLIGHT  
DETAIL



900421



incl./inkl./inclus

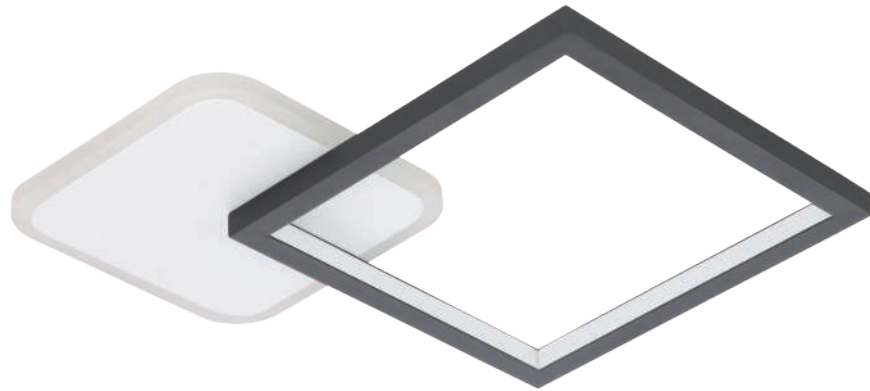

900422



incl./inkl./inclus

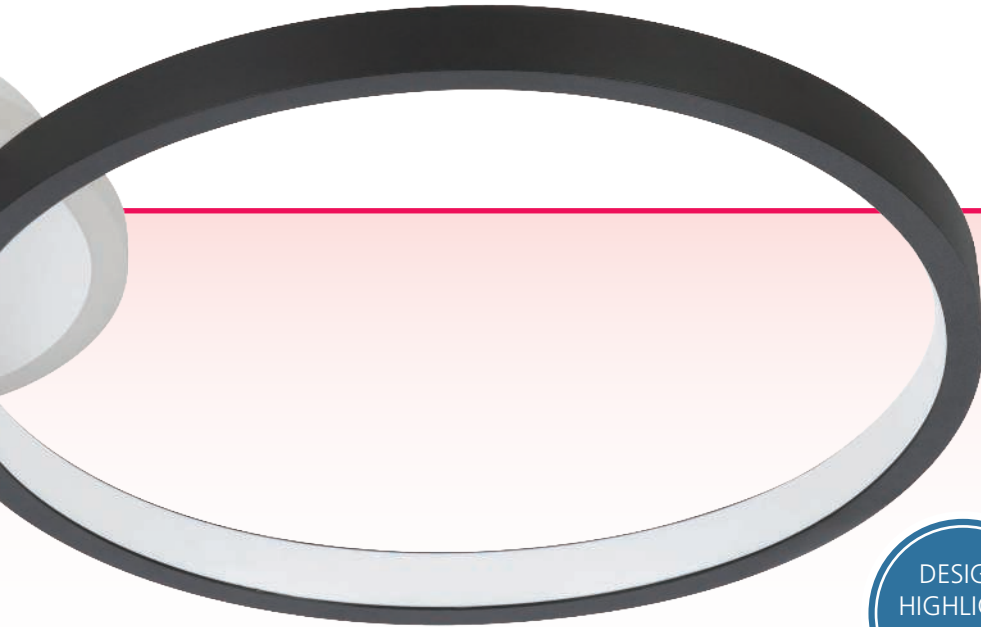

**900421 GAFARES**

ceiling light; aluminium, steel, black, white / plastic, white  
 Deckenleuchte; Alu, Stahl, schwarz, weiss / Kunststoff, weiss  
 plafonnier; aluminium, acier, noir, blanc / plastique, blanc

L 405, B 290, H 55



15W



2100lm



Remote



9 008606 241002





**900423**

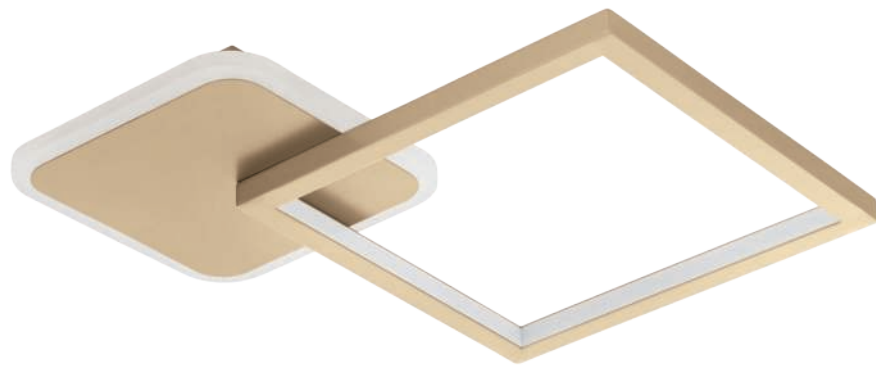

**900424**



**900422 GAFARES**

ceiling light; aluminium, steel, black, white / plastic, white  
Deckenleuchte; Alu, Stahl, schwarz, weiss / Kunststoff, weiss  
plafonnier; aluminium, acier, noir, blanc / plastique, blanc

L 330, B 330, H 50



**900423 GAFARES**

ceiling light; aluminium, steel, gold, white / plastic, white  
Deckenleuchte; Alu, Stahl, gold, weiss / Kunststoff, weiss  
plafonnier; aluminium, acier, or, blanc / plastique, blanc

L 405, B 290, H 55



**900424 GAFARES**

ceiling light; aluminium, steel, gold, white / plastic, white  
Deckenleuchte; Alu, Stahl, gold, weiss / Kunststoff, weiss  
plafonnier; aluminium, acier, or, blanc / plastique, blanc

L 330, B 330, H 50

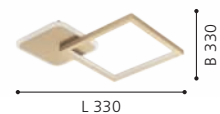
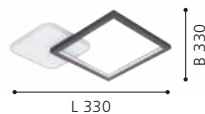



99817

LED



98491

LED



98494

LED

### 99817 IPOLITTO

ceiling light; aluminium, steel, black / plastic, white  
Deckenleuchte; Alu, Stahl, schwarz / Kunststoff, weiss  
plafonnier; aluminium, acier, noir / plastique, blanc

L 995, B 165, H 245



4x 7,5W 3600lm

### 98491 AMONTILLADO

ceiling light; aluminium, steel, black / plastic, white  
Deckenleuchte; Alu, Stahl, schwarz / Kunststoff, weiss  
plafonnier; aluminium, acier, noir / plastique, blanc

L 1125, B 8



2x 13,5W 3500lm

### 98494 SPADAFORA

ceiling light; aluminium, steel, black / plastic, clear, white  
Deckenleuchte; Alu, Stahl, schwarz / Kunststoff, klar, weiss  
plafonnier; aluminium, acier, noir / plastique, transparent, blanc

L 1160, B 80, H 100



21,5W 2500lm



9 002759 998172

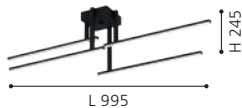

L 995



9 002759 984915



L 1125



9 002759 984946



L 1160





900328

LED



900329

LED



### 900328 ZAMPOTE

ceiling light; aluminium, steel, white, black / plastic, white  
Deckenleuchte; Alu, Stahl, weiss, schwarz / Kunststoff, weiss  
plafonnier; aluminium, acier, blanc, noir / plastique, blanc

H 50, Ø 420



25W 3400lm

### 900329 ZAMPOTE

ceiling light; aluminium, steel, white, black / plastic, white  
Deckenleuchte; Alu, Stahl, weiss, schwarz / Kunststoff, weiss  
plafonnier; aluminium, acier, blanc, noir / plastique, blanc

L 380, B 380, H 50



25W 3300lm



9 008606 238095



9 008606 238101

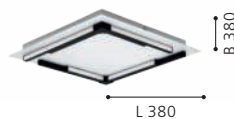



900603

LED



incl./inkl./inclus

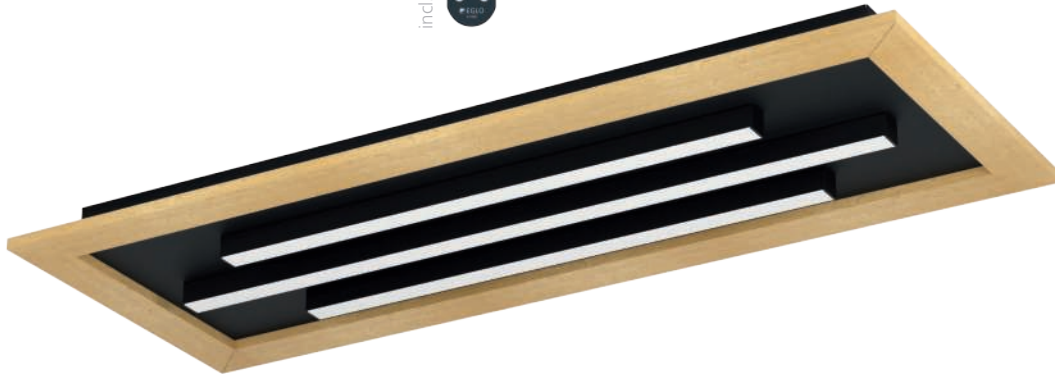

900604

LED



incl./inkl./inclus



99793

LED

### 900603 TIRRENARA

ceiling light; steel, wood, black, brown / plastic, white  
Deckenleuchte; Stahl, Holz, schwarz, braun / Kunststoff, weiss  
plafonnier; acier, bois, noir, marron / plastique, blanc

L 370, B 370, H 55



4x 5,4W 2600lm

Remote

### 900604 TIRRENARA

ceiling light; steel, wood, black, brown / plastic, white  
Deckenleuchte; Stahl, Holz, schwarz, braun / Kunststoff, weiss  
plafonnier; acier, bois, noir, marron / plastique, blanc

L 780, B 305, H 55



2x 9,2W 3960lm 1x 13,7W

Remote

### 99793 MARINELLO 1

ceiling light; aluminium, steel, wood, black, brown / plastic, white  
Deckenleuchte; Alu, Stahl, Holz, schwarz, braun / Kunststoff, weiss  
plafonnier; aluminium, acier, bois, noir, marron / plastique, blanc

L 500, B 500, H 90



4x 5,3W 2800lm



9 008606 245017

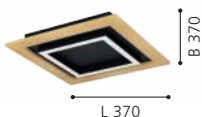

9 008606 245024

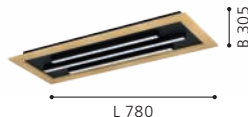

9 002759 997939

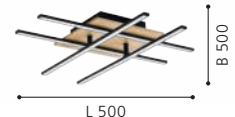



99659

LED

incl./inkl./inclus



## 99659 MARINELLO

ceiling light; aluminium, steel, wood, black, brown / plastic, white

Deckenleuchte; Alu, Stahl, Holz, schwarz, braun / Kunststoff, weiss

plafonnier; aluminium, acier, bois, noir, marron / plastique, blanc

L 485, B 485, H 55



2x 17W



3800lm



4,2W



550lm



Remote



9 002759 996598

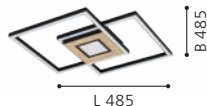



98861



MIRLAS



98862



### 98861 MIRLAS

ceiling light; wood, steel, brown / plastic, white  
Deckenleuchte; Holz, Stahl, braun / Kunststoff, weiss  
plafonnier; bois, acier, marron / plastique, blanc

L 360, B 210, H 90



E27



2x 9W



9 002759 988616



### 98862 MIRLAS

ceiling light; wood, steel, brown / plastic, white  
Deckenleuchte; Holz, Stahl, braun / Kunststoff, weiss  
plafonnier; bois, acier, marron / plastique, blanc

L 690, B 270, H 90



E27



4x 9W



9 002759 988623

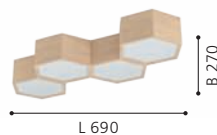

### 98863 MIRLAS

ceiling light; wood, steel, brown / plastic, white  
Deckenleuchte; Holz, Stahl, braun / Kunststoff, weiss  
plafonnier; bois, acier, marron / plastique, blanc

L 540, B 520, H 90



E27



6x 9W



9 002759 988630

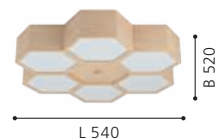





98863



99656

LED



### TAMURIA

This luminaires have rotatable panels in wood look and black.

Diese Artikel verfügen über Platten in Holzoptik und schwarz zum Wechseln.

Ces luminaires a des panneaux en bois optique et noir à changer.

#### 99656 TAMURIA

ceiling light; steel, wood, black, brown / plastic, white  
Deckenleuchte; Stahl, Holz, schwarz, braun / Kunststoff, weiss  
plafonnier; acier, bois, noir, marron / plastique, blanc

L 435, B 435, H 70



21W 2700lm

#### 99655 TAMURIA

ceiling light; steel, wood, black, brown / plastic, white  
Deckenleuchte; Stahl, Holz, schwarz, braun / Kunststoff, weiss  
plafonnier; acier, bois, noir, marron / plastique, blanc

L 285, B 285, H 60



10,8W 1300lm



9 002759 996567



9 002759 996550





99655

LED



900571

LED

incl./inkl./inclus



900572

LED

incl./inkl./inclus



900573

LED

incl./inkl./inclus



### 900571 BORDONARA

ceiling light; aluminium, steel, black, white / plastic, white  
Deckenleuchte; Alu, Stahl, schwarz, weiss / Kunststoff, weiss  
plafonnier; aluminium, acier, noir, blanc / plastique, blanc

L 450, B 450

LED

21,5W

RGB+TW

2800lm



### 900572 BORDONARA

ceiling light; aluminium, steel, black, white / plastic, white  
Deckenleuchte; Alu, Stahl, schwarz, weiss / Kunststoff, weiss  
plafonnier; aluminium, acier, noir, blanc / plastique, blanc

L 595, B 595

LED

36W

RGB+TW

4900lm



### 900573 BORDONARA

ceiling light; aluminium, steel, black, white / plastic, white  
Deckenleuchte; Alu, Stahl, schwarz, weiss / Kunststoff, weiss  
plafonnier; aluminium, acier, noir, blanc / plastique, blanc

L 1195, B 295

LED

35W

RGB+TW

5400lm



9 008606 244720

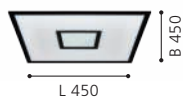

9 008606 244737



9 008606 244744







900558



900559



900561



### 900558 MARMORATA

ceiling light; aluminium, steel, black, white / plastic, white  
Deckenleuchte; Alu, Stahl, schwarz, weiss / Kunststoff, weiss  
plafonnier; aluminium, acier, noir, blanc / plastique, blanc

H 70, Ø 450



18W 2300lm 9W 1100lm



9 008606 244614



### 900559 MARMORATA

ceiling light; aluminium, steel, black, white / plastic, white  
Deckenleuchte; Alu, Stahl, schwarz, weiss / Kunststoff, weiss  
plafonnier; aluminium, acier, noir, blanc / plastique, blanc

L 445, B 445



19W 2400lm 9W 1200lm



9 008606 244621



### 900561 MARMORATA

ceiling light; aluminium, steel, black, white / plastic, white  
Deckenleuchte; Alu, Stahl, schwarz, weiss / Kunststoff, weiss  
plafonnier; aluminium, acier, noir, blanc / plastique, blanc

L 595, B 295



17W 2400lm 9W 1100lm



9 008606 244638

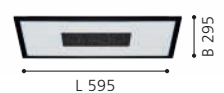



**98319**



**98317**



**98318**

**98319 BOCADELLA 1**

ceiling light; steel, black  
Deckenleuchte; Stahl, schwarz  
plafonnier; acier, noir

H 360, Ø 920



E27 12x 60W

**98317 BOCADELLA 1**

ceiling light; steel, black  
Deckenleuchte; Stahl, schwarz  
plafonnier; acier, noir

H 215, Ø 345



E27 3x 60W

**98318 BOCADELLA 1**

ceiling light; steel, black  
Deckenleuchte; Stahl, schwarz  
plafonnier; acier, noir

H 365, Ø 640



E27 9x 60W



9 002759 983192

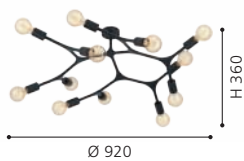

9 002759 983178

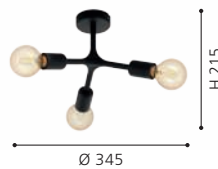

9 002759 983185

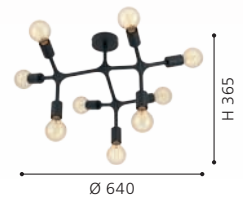



98679



98507

### 98679 MUSARA

ceiling light; steel, black  
Deckenleuchte; Stahl, schwarz  
plafonnier; acier, noir

H 850, Ø 790

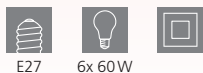

E27 6x 60W



9 002759 986797

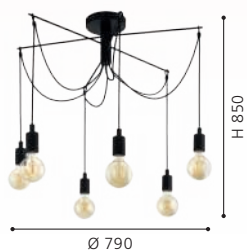

### 98507 TREMEDAL

ceiling light; steel, black  
Deckenleuchte; Stahl, schwarz  
plafonnier; acier, noir

H 215, Ø 560



E27 1x 28W



9 002759 985073

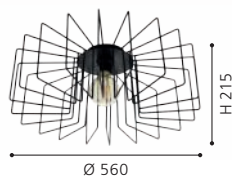



**900367**



**98034**



**98035**

### 900367 MESSINARO

ceiling light; steel, black, brushed brass  
Deckenleuchte; Stahl, schwarz, messing-gebürstet  
plafonnier; acier, noir, laiton brossé

L 720, B 280, H 115



E27 3x 40W

### 98034 BELSIANA

ceiling light; steel, black  
Deckenleuchte; Stahl, schwarz  
plafonnier; acier, noir

L 890, B 510, H 350



E27 6x 40W

### 98035 BELSIANA

ceiling light; steel, black  
Deckenleuchte; Stahl, schwarz  
plafonnier; acier, noir

L 1180, B 510, H 350



E27 8x 40W



9 008606 243525

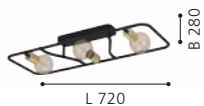

9 002759 980344

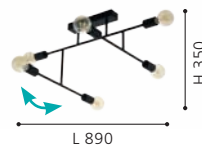

9 002759 980351

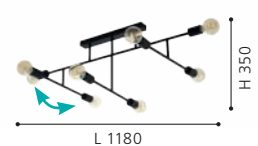





99664



98882

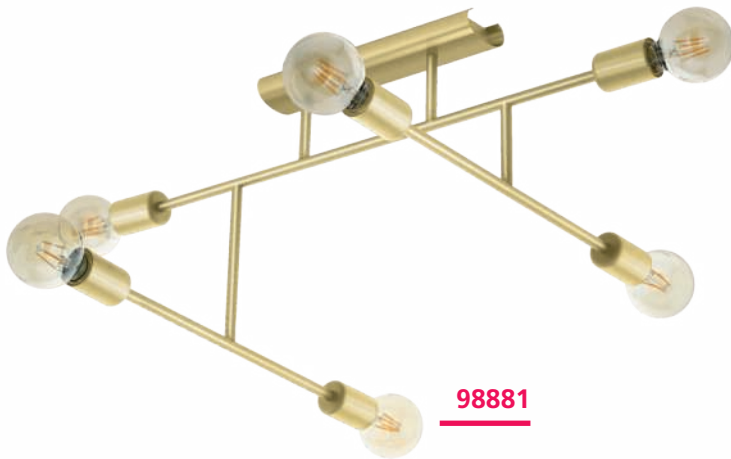

98881



### 99664 ENCINITOS

ceiling light; steel, black, gold  
Deckenleuchte; Stahl, schwarz, gold  
plafonnier; acier, noir, or

H 260, Ø 450



E27 1x 40W

### 98881 BELSIANA 1

ceiling light; steel, brushed brass  
Deckenleuchte; Stahl, messing-gebürstet  
plafonnier; acier, laiton brossé

L 1155, B 495, H 455



E27 6x 40W

### 98882 BELSIANA 1

ceiling light; steel, brushed brass  
Deckenleuchte; Stahl, messing-gebürstet  
plafonnier; acier, laiton brossé

L 1180, B 380, H 350



E27 8x 40W



9 002759 996642

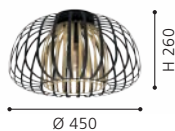

9 002759 988814

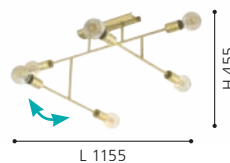

9 002759 988821

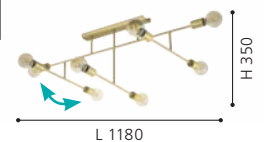



97731

LED



900302



### 97731 MONTEBALDO

ceiling light; steel, black, gold  
Deckenleuchte; Stahl, schwarz, gold  
plafonnier; acier, noir, or

L 380, B 380, H 170



GU10



4x 4,5W



warm  
WHITE

4x

345lm

### 900302 BARRANCAS

ceiling light; steel, black, gold / brilliant glass, clear  
Deckenleuchte; Stahl, schwarz, gold / Brillantglas, klar  
plafonnier; acier, noir, or / verre brillant, transparent

L 380, B 380, H 180



E14



4x 40W

DESIGN  
HIGHLIGHT  
DETAIL



9 002759 977313

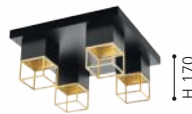

L 380

H 170



9 008606 242764



L 380

H 180



**900524**



**97904**



**97895**

### 900524 MORDAZO

ceiling light; steel, black / fabric, wood, anthracite-brown, white  
 Deckenleuchte; Stahl, schwarz / Textil, Holz, anthrazit-braun, weiss  
 plafonnier; acier, noir / textile, bois, marron anthracite, blanc

L 510, B 510, H 175



E27 4x 28W

### 97904 STAITI

ceiling light; steel, black  
 Deckenleuchte; Stahl, schwarz  
 plafonnier; acier, noir

H 140, Ø 760



E27 7x 60W

### 97895 STAITI

ceiling light; steel, black / fabric, black, gold  
 Deckenleuchte; Stahl, schwarz / Textil, schwarz, gold  
 plafonnier; acier, noir / tissu, noir, or

H 235, Ø 840



E27 7x 40W



9 008606 244522

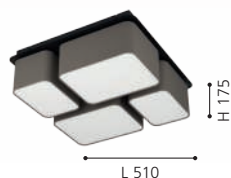

L 510

H 175



9 002759 979041

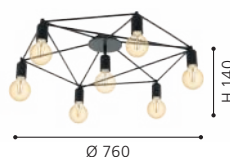

Ø 760

H 140



9 002759 978952



Ø 840

H 235





**98333**



**98331**



**98332**

**98333 SILENTINA**

ceiling light; steel, black  
Deckenleuchte; Stahl, schwarz  
plafonnier; acier, noir

L 540, B 180, H 205



E27



3x 40W



9 002759 983338

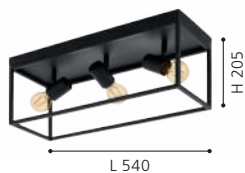

**98331 SILENTINA**

ceiling light; steel, black  
Deckenleuchte; Stahl, schwarz  
plafonnier; acier, noir

L 180, B 180, H 205



E27



1x 40W



9 002759 983314

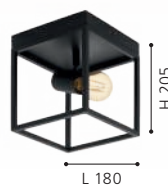

**98332 SILENTINA**

ceiling light; steel, black  
Deckenleuchte; Stahl, schwarz  
plafonnier; acier, noir

L 360, B 180, H 205



E27



2x 40W



9 002759 983321







98334



900509

### 98334 SILENTINA

ceiling light; steel, black  
Deckenleuchte; Stahl, schwarz  
plafonnier; acier, noir

L 360, B 360, H 205



9 002759 983345

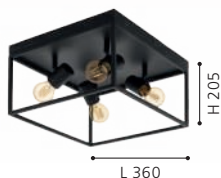

### 900509 MACCHIONE

wall light; steel, black, brass  
Wandleuchte; Stahl, schwarz, messing  
applique; acier, noir, laiton

L 500, H 110, A 85



9 008606 244393

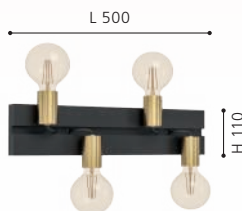

### MACCHIONE

Frames can be individually aligned for the customer using a magnet. The luminaire works both as a wall luminaire and as a ceiling luminaire.

Fassungen sind mithilfe eines Magnets für den Kunden individuell ausrichtbar. Die Leuchte funktioniert sowohl als Wandleuchte, als auch als Deckenleuchte.

Les cadres peuvent être alignés individuellement pour le client à l'aide d'un aimant. La luminaire fonctionne à la fois comme applique murale et comme plafonnier.





### 900357 PIEDRITAS

ceiling light; steel, black  
Deckenleuchte; Stahl, schwarz  
plafonnier; acier, noir

L 730, B 180, H 205



### 900356 PIEDRITAS

ceiling light; steel, black  
Deckenleuchte; Stahl, schwarz  
plafonnier; acier, noir

L 515, B 180, H 205



### 900355 PIEDRITAS

ceiling light; steel, black  
Deckenleuchte; Stahl, schwarz  
plafonnier; acier, noir

L 180, B 180, H 205

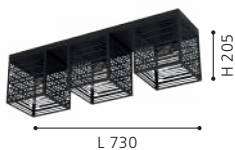



900355





**94547**



**94548**



**900359**

**94547 MOGANO**

ceiling light; steel, black, copper  
Deckenleuchte; Stahl, schwarz, kupfer  
plafonnier; acier, noir, cuivre

H 170, Ø 400

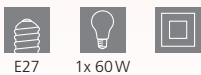

**94548 MOGANO**

ceiling light; steel, white, silver  
Deckenleuchte; Stahl, weiss, silber  
plafonnier; acier, blanc, argent

H 170, Ø 400



**900359 MOGANO**

ceiling light; steel, Mokka colour  
Deckenleuchte; Stahl, Mokkafarben  
plafonnier; acier, café

H 175, Ø 400



9 002759 945473

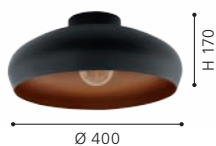

9 002759 945480



9 008606 235315

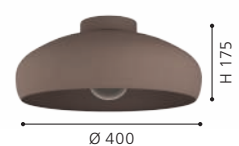





**43637**

**43637 MOGANO**

ceiling light; steel, black  
Deckenleuchte; Stahl, schwarz  
plafonnier; acier, noir

H 170, Ø 400



E27



1x 60W



9 002759 436377

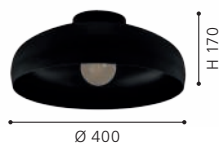



900553



**900554**



**900555**

**900553 MOGANO 2**

ceiling light; steel, black  
Deckenleuchte; Stahl, schwarz  
plafonnier; acier, noir

H 175, Ø 280



E27 1x 40W

**900554 MOGANO 2**

ceiling light; steel, black, gold  
Deckenleuchte; Stahl, schwarz, gold  
plafonnier; acier, noir, or

H 175, Ø 280



E27 1x 40W

**900555 MOGANO 2**

ceiling light; steel, black, copper  
Deckenleuchte; Stahl, schwarz, kupfer  
plafonnier; acier, noir, cuivre

H 175, Ø 280



E27 1x 40W



9 008606 244584



9 008606 244591



9 008606 244607

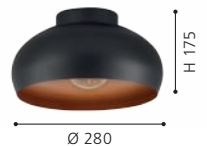



99515

LED



99514

LED



99516

LED

### 99514 VALCASOTTO

ceiling light; steel, black  
Deckenleuchte; Stahl, schwarz  
plafonnier; acier, noir

L 110, B 110, H 100



GU10



1x 4,5W



1x  
warm  
WHITE  
345lm

### 99515 VALCASOTTO

ceiling light; steel, black  
Deckenleuchte; Stahl, schwarz  
plafonnier; acier, noir

L 570, B 100, H 100



GU10



4x 4,5W



4x  
warm  
WHITE  
345lm

### 99516 VALCASOTTO

ceiling light; steel, black  
Deckenleuchte; Stahl, schwarz  
plafonnier; acier, noir

L 320, B 320, H 100



GU10



4x 4,5W



4x  
warm  
WHITE  
345lm



9 002759 995140



L 110



9 002759 995157



L 570



9 002759 995164



L 320





900435



900443



### 900435 VALCASOTTO 1

ceiling light; steel, wood, black, brown  
 Deckenleuchte; Stahl, Holz, schwarz, braun  
 plafonnier; acier, bois, noir, marron

L 370, B 370, H 100



GU10



4x 4,5W



4x  
 warm  
 WHITE  
 345 lm

### 900443 TARRAFO

ceiling light; steel, wood, black, brown  
 Deckenleuchte; Stahl, Holz, schwarz, braun  
 plafonnier; acier, bois, noir, marron

L 640, B 150, H 155



E27



3x 40W

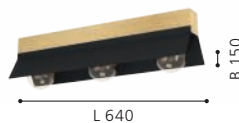
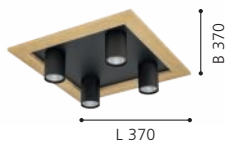



**99667**



**900188**



DESIGN  
HIGHLIGHT  
DETAIL

**99667 BASURTU**

ceiling light; steel, black  
Deckenleuchte; Stahl, schwarz  
plafonnier; acier, noir

H 270, Ø 1050



E27



5x 40W



9 002759 996673

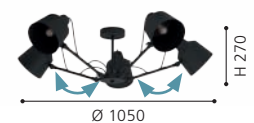



900157



900614

### 900188 LORETO

ceiling light; steel, black, white  
Deckenleuchte; Stahl, schwarz, weiss  
plafonnier; acier, noir, blanc

H 355, Ø 1145



E27 3x 25W



9 008606 235629

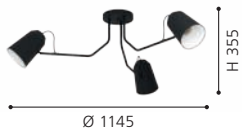

### 900157 LORETO

wall light; steel, black, white  
Wandleuchte; Stahl, schwarz, weiss  
applique; acier, noir, blanc

L 670, B 140, H 365



E27 1x 40W



9 008606 235766



### 900614 LORETO 1

wall light; steel, black, white  
Wandleuchte; Stahl, schwarz, weiss  
applique; acier, noir, blanc

L 140, H 350, A 1030



E27 1x 28W



9 008606 245116

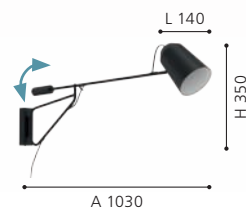



900361







900185



98514



98514

### 900361 MARIEL

ceiling light; steel, wood, light grey, brown  
Deckenleuchte; Stahl, Holz, hellgrau, braun  
plafonnier; acier, bois, gris clair, marron

L 910, B 190, H 255



E27



3x 40W

### 900185 FILAGO

ceiling light; steel, wood, black, brown / glass, black-grey-transparent  
Deckenleuchte; Stahl, Holz, schwarz, braun / Glas, schwarz-grau-transparent  
plafonnier; acier, bois, noir, marron / verre, noir-gris-transparent

L 880, B 145, H 250



E27



4x 40W

### 98514 MAROJALES

ceiling light; steel, black / glass vaporized, black-transparent  
Deckenleuchte; Stahl, schwarz / Glas bedampft, schwarz-transparent  
plafonnier; acier, noir / verre vaporisé, noir transparent

L 555, B 180, H 280



E27



2x 28W



9 008606 239108



L 910



9 008606 235322

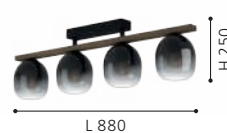

L 880



9 002759 985141



L 555



30933

LED



30931

LED

### 30933 CABO

ceiling light; stainless steel, chrome / satin glass, white, clear  
Deckenleuchte; Edelstahl, chrom / Glas satiniert, weiss, klar  
plafonnier; acier inoxydable, chrome / verre satiné, blanc, transparent

H 70, Ø 350



GU10



5x 2,8W



5x  
warm  
WHITE  
250lm



9 002759 309336



### 30931 CABO

ceiling light; stainless steel, chrome / satin glass, white, clear  
Deckenleuchte; Edelstahl, chrom / Glas satiniert, weiss, klar  
plafonnier; acier inoxydable, chrome / verre satiné, blanc, transparent

L 290, B 290, H 70



GU10



4x 2,8W



4x  
warm  
WHITE  
250lm



9 002759 309312



### 92727 CONDRA 1

ceiling light; steel, chrome / satin glass, white  
Deckenleuchte; Stahl, chrom / Glas satiniert, weiss  
plafonnier; acier, chrome / verre satiné, blanc

L 470, B 470, H 300



G9



8x 18W



9 002759 927271

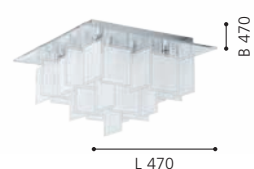



92727





**95285**



**95284**



CLEMENTE

**95285 CLEMENTE**

ceiling light; steel, chrome / brilliant glass, clear  
 Deckenleuchte; Stahl, chrom / Brillantglas, klar  
 plafonnier; acier, chrome / verre brillant, transparent

H 205, Ø 450



**95284 CLEMENTE**

ceiling light; steel, chrome / brilliant glass, clear  
 Deckenleuchte; Stahl, chrom / Brillantglas, klar  
 plafonnier; acier, chrome / verre brillant, transparent

H 200, Ø 350

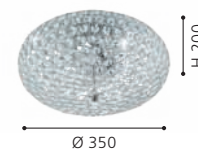
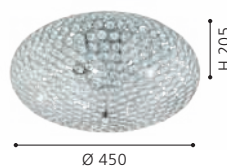





95639

LED



99356

LED



32025

LED

### 99356 ACOLLA 1

wall / ceiling light; steel, black / glass with brilliant glass, white, clear

Wand- / Deckenleuchte; Stahl, schwarz / Glas mit Brillantglas, weiss, klar

Applique/Plafonnier; acier, noir / verre avec verre brillant, blanc, transparent

H 85, Ø 290



11W 1300lm

### 95639 ACOLLA

wall / ceiling light; steel, chrome / glass with brilliant glass, white, clear

Wand- / Deckenleuchte; Stahl, chrom / Glas mit Brillantglas, weiss, klar

Applique/Plafonnier; acier, chrome / verre avec verre brillant, blanc, transparent

H 85, Ø 290



3x 11W 3x 950lm

### 32025 CARDITO

ceiling light; steel, chrome / glass, brilliant glass, clear

Deckenleuchte; Stahl, chrom / Glas, Brillantglas, klar

plafonnier; acier, chrome / verre, verre brillant, transparent

L 320, B 320, H 55



16W 2500lm



9 002759 993566



9 002759 956394



9 002759 320256

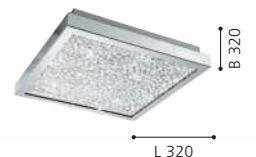



99324



99325



99328



### 99324 FRADELO 1

wall / ceiling light; steel, black / plastic, brilliant glass, black, clear

Wand- / Deckenleuchte; Stahl, schwarz / Kunststoff, Brillantglas, schwarz, klar

Applique/Plafonnier; acier, noir / plastique, verre brillant, noir, transparent

L 140, B 140, H 60



1x 3,2W 400lm

### 99325 FRADELO 1

wall / ceiling light; steel, black / plastic, brilliant glass, black, clear

Wand- / Deckenleuchte; Stahl, schwarz / Kunststoff, Brillantglas, schwarz, klar

Applique/Plafonnier; acier, noir / plastique, verre brillant, noir, transparent

L 460, B 140, H 60



3x 3,5W 1200lm

### 99328 FRADELO 1

ceiling light; steel, black / plastic, brilliant glass, black, clear

Deckenleuchte; Stahl, schwarz / Kunststoff, Brillantglas, schwarz, klar

plafonnier; acier, noir / plastique, verre brillant, noir, transparent

L 520, B 520, H 95



46,5W 5500lm



9 002759 993245

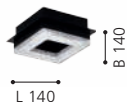

9 002759 993252

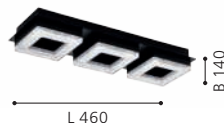

9 002759 993283





99327

LED

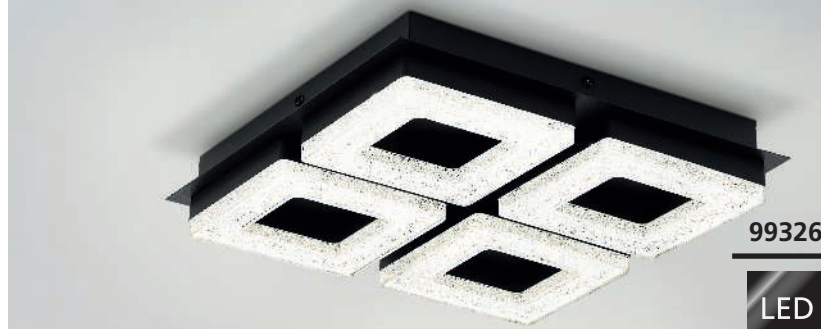

99326

LED



### 99327 FRADELO 1

ceiling light; steel, black / plastic, brilliant glass, black, clear  
 Deckenleuchte; Stahl, schwarz / Kunststoff, Brillantglas, schwarz, klar  
 plafonnier; acier, noir / plastique, verre brillant, noir, transparent

L 260, B 260, H 85



4x 2W 920lm 1x 3,5W 400lm



9 002759 993276

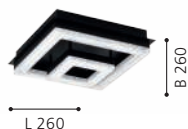

### 99326 FRADELO 1

wall / ceiling light; steel, black / plastic, brilliant glass, black, clear  
 Wand- / Deckenleuchte; Stahl, schwarz / Kunststoff, Brillantglas, schwarz, klar  
 Applique/Plafonnier; acier, noir / plastique, verre brillant, noir, transparent

L 280, B 280, H 60



4x 3,5W 1600lm



9 002759 993269

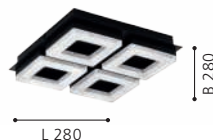

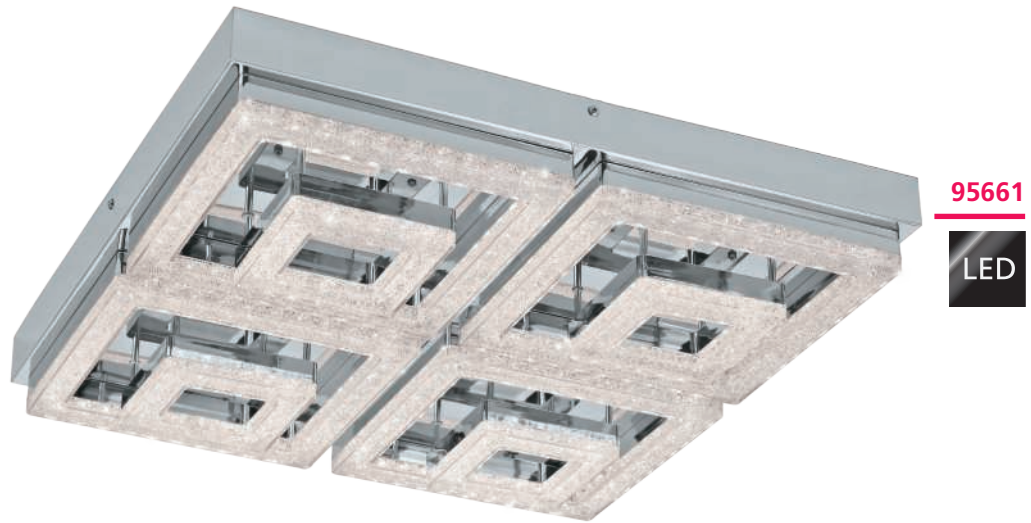
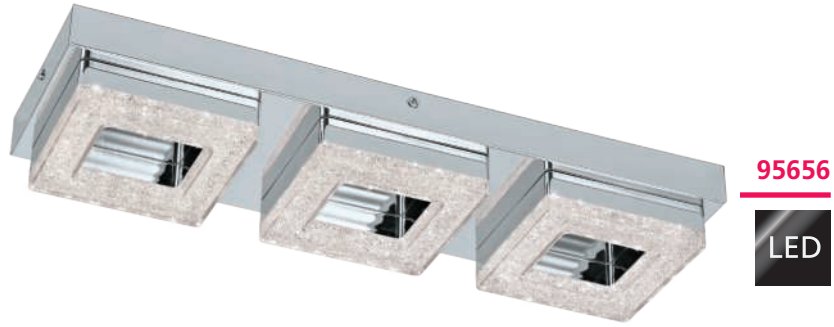

### 95655 FRADELO

wall / ceiling light; steel, chrome / plastic, brilliant glass, chrome, clear

Wand- / Deckenleuchte; Stahl, chrom / Kunststoff, Brillantglas, chrom, klar

Applique/Plafonnier; acier, chrome / plastique, verre brillant, chrome, transparent

L 140, B 140, H 60



1x 3,2W 400lm

### 95656 FRADELO

wall / ceiling light; steel, chrome / plastic, brilliant glass, chrome, clear

Wand- / Deckenleuchte; Stahl, chrom / Kunststoff, Brillantglas, chrom, klar

Applique/Plafonnier; acier, chrome / plastique, verre brillant, chrome, transparent

L 460, B 140, H 60



3x 3,5W 1200lm

### 95661 FRADELO

ceiling light; steel, chrome / plastic, brilliant glass, chrome, clear

Deckenleuchte; Stahl, chrom / Kunststoff, Brillantglas, chrom, klar

plafonnier; acier, chrome / plastique, verre brillant, chrome, transparent

L 520, B 520, H 95



46,5W 5500lm



9 002759 956554

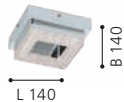

9 002759 956561

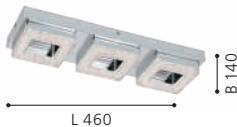

9 002759 956615







95657

LED

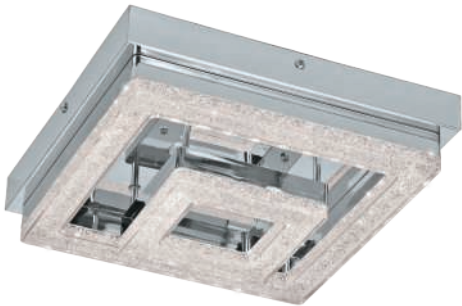

95659

LED



95658

LED



### 95657 FRADELO

wall / ceiling light; steel, chrome / plastic, brilliant glass, chrome, clear

Wand- / Deckenleuchte; Stahl, chrom / Kunststoff, Brillantglas, chrom, klar

Applique/Plafonnier; acier, chrome / plastique, verre brillant, chrome, transparent

L 280, B 280, H 60



4x 3,5W 1600lm

### 95659 FRADELO

ceiling light; steel, chrome / plastic, brilliant glass, chrome, clear

Deckenleuchte; Stahl, chrom / Kunststoff, Brillantglas, chrom, klar

plafonnier; acier, chrome / plastique, verre brillant, chrome, transparent

L 260, B 260, H 85



4x 2W 920lm 1x 3,5W 400lm



### 95658 FRADELO

wall / ceiling light; steel, chrome / plastic, brilliant glass, chrome, clear

Wand- / Deckenleuchte; Stahl, chrom / Kunststoff, Brillantglas, chrom, klar

Applique/Plafonnier; acier, chrome / plastique, verre brillant, chrome, transparent

L 440, B 440, H 70



9x 3,8W 3780lm



9 002759 956578

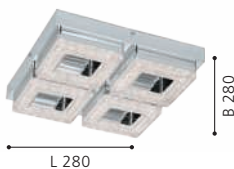

9 002759 956592

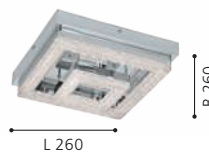

9 002759 956585





95664

LED



95662

LED



DESIGN  
HIGHLIGHT  
DETAIL

### 95664 FRADELO

wall / ceiling light; steel, chrome / plastic, brilliant glass, chrome, clear

Wand- / Deckenleuchte; Stahl, chrom / Kunststoff, Brillantglas, chrom, klar

Applique/Plafonnier; acier, chrome / plastique, verre brillant, chrome, transparent

L 280, B 280, H 60

LED

warm  
WHITE



4x 3,5W 1600lm

### 95662 FRADELO

wall / ceiling light; steel, chrome / plastic, brilliant glass, chrome, clear

Wand- / Deckenleuchte; Stahl, chrom / Kunststoff, Brillantglas, chrom, klar

Applique/Plafonnier; acier, chrome / plastique, verre brillant, chrome, transparent

L 140, B 140, H 60

LED

warm  
WHITE



1x 3,2W 400lm



9 002759 956646

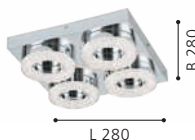

9 002759 956622





95689



### VALLEMARE

These luminaires come with high quality brilliant glass.

Diese Leuchten sind mit hochwertigem Brillantglas ausgestattet.

Ces lumières sont fabriquées avec une haute qualité Equipé de verre brillant.

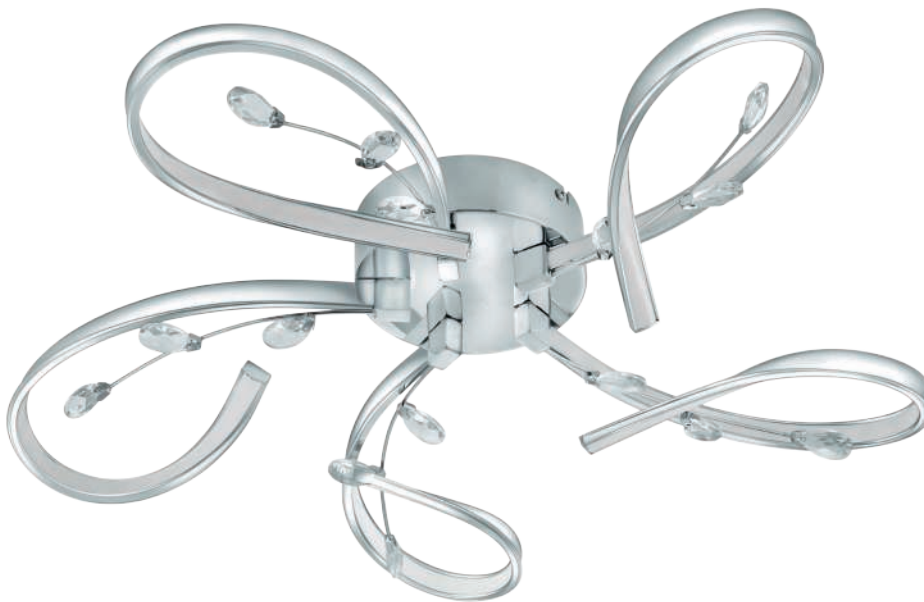

97487



### 95689 SORRENTA 1

wall / ceiling light; steel, white / glass with brilliant glass, white, clear

Wand- / Deckenleuchte; Stahl, weiss / Glas mit Brillantglas, weiss, klar

Applique/Plafonnier; acier, blanc / verre avec verre brillant, blanc, transparent

H 95, Ø 315



3x 3,8W 1170lm

### 97487 VALLEMARE

wall / ceiling light; aluminium, steel, chrome / plastic, brilliant glass, white, clear

Wand- / Deckenleuchte; Alu, Stahl, chrom / Kunststoff, Brillantglas, weiss, klar

Applique/Plafonnier; aluminium, acier, chrome / plastique, verre brillant, blanc, transparent

H 125, Ø 650



5x 6,6W 4500lm



### SORRENTA 1

These luminaires come with high quality brilliant glass.

Diese Leuchten sind mit hochwertigem Brillantglas ausgestattet.

Ces lumières sont fabriquées avec une haute qualité Equipé de verre brillant.



9 002759 956899

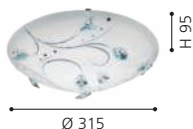

9 002759 974879

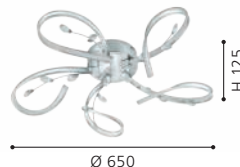



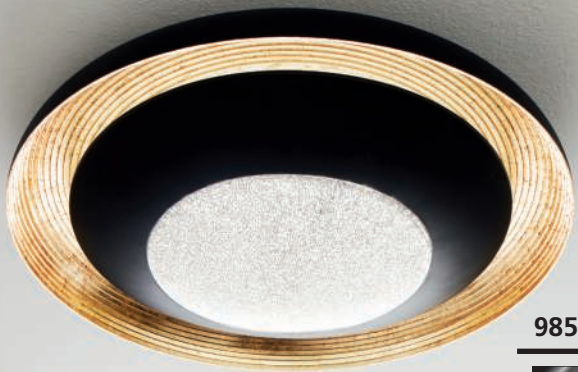

98527

LED

incl./inkl./inclus



 <b>TUNABLE WHITE</b>	 <b>STEP DIMMING</b>	 <b>NIGHT LIGHT FUNCTION</b>	<b>98527</b> <hr/> <b>98685</b>
1. warmwhite (2700K/100%) 2. neutralwhite 3850K (2700K/50% + 5000K/50%) 3. coldwhite (5000K/100%)			



98685

LED

incl./inkl./inclus



**98527 CANICOSA 2**

wall / ceiling light; plastic, steel, black, gold / plastic with granille, transparent

Wand- / Deckenleuchte; Kunststoff, Stahl, schwarz, gold / Kunststoff mit Granille, transparent

applique / plafonnier; plastique, acier, noir, or / plastique granité, transparent

H 90, Ø 495

				
24,5W	3200lm		Remote	

**98685 CANICOSA 2**

wall / ceiling light; plastic, steel, black, gold / plastic with granille, transparent

Wand- / Deckenleuchte; Kunststoff, Stahl, schwarz, gold / Kunststoff mit Granille, transparent

applique / plafonnier; plastique, acier, noir, or / plastique granité, transparent

H 145, Ø 765

				
4x 4,5W	2120lm		Remote	



9 002759 985271

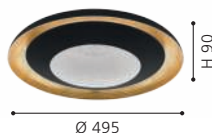

9 002759 986858

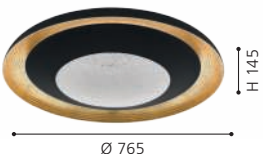





98487

LED



98023

LED



98488

LED

### 98023 MONTENOVO

wall / ceiling light; steel, white / glass, white, gold  
Wand- / Deckenleuchte; Stahl, weiss / Glas, weiss, gold  
applique / plafonnier; acier, blanc / verre, blanc, or

H 100, Ø 395



3x 7,3W 2220lm

### 98487 POZONDON

ceiling light; steel, gold-coloured / plastic, white  
Deckenleuchte; Stahl, goldfarben / Kunststoff, weiss  
plafonnier; acier, or / plastique, blanc

H 100, Ø 380



18W 2300lm

### 98488 POZONDON

ceiling light; steel, gold-coloured / plastic, white  
Deckenleuchte; Stahl, goldfarben / Kunststoff, weiss  
plafonnier; acier, or / plastique, blanc

H 120, Ø 520



22,5W 3100lm



9 002759 980238



9 002759 984878

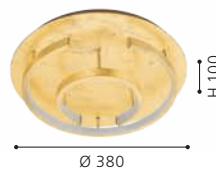

9 002759 984885

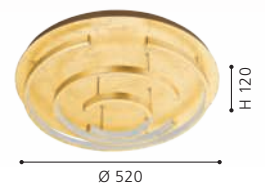



97526



incl./inkl./inclus



97527



incl./inkl./inclus



97528



incl./inkl./inclus



				<u>97526</u>	<u>97541</u>
<b>TUNABLE WHITE</b>	<b>DIMMABLE</b>	<b>TIMER FUNCTION</b>	<b>NIGHT LIGHT FUNCTION</b>	<u>97527</u>	<u>97542</u>
3000 - 5000 K	10 - 100 %	off after 30sec.		<u>97528</u>	<u>97543</u>

### 97526 GIRON

ceiling light; steel, white / plastic, white  
Deckenleuchte; Stahl, weiss / Kunststoff, weiss  
plafonnier; acier, blanc / plastique, blanc

H 75, Ø 570



36W



4300lm



Remote

### 97527 GIRON

ceiling light; steel, white / plastic, white  
Deckenleuchte; Stahl, weiss / Kunststoff, weiss  
plafonnier; acier, blanc / plastique, blanc

H 85, Ø 760



54,5W



6500lm



Remote

### 97528 GIRON

ceiling light; steel, white / plastic, white  
Deckenleuchte; Stahl, weiss / Kunststoff, weiss  
plafonnier; acier, blanc / plastique, blanc

H 120, Ø 1000



73W



9800lm



Remote



9 002759 975265

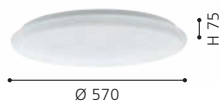

9 002759 975272

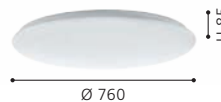

9 002759 975289

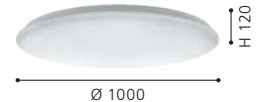



97541



incl./inkl./inclus



97542



incl./inkl./inclus



97543



incl./inkl./inclus



### 97541 GIRON-S

ceiling light; steel, white / plastic with crystal effect, white  
Deckenleuchte; Stahl, weiss / Kunststoff m.Kristalleffekt, weiss  
plafonnier; acier, blanc / plastique avec effet cristal, blanc

H 75, Ø 570



36W



4300lm



Remote



9 002759 975418

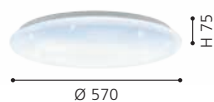

Ø 570

### 97542 GIRON-S

ceiling light; steel, white / plastic with crystal effect, white  
Deckenleuchte; Stahl, weiss / Kunststoff m.Kristalleffekt, weiss  
plafonnier; acier, blanc / plastique avec effet cristal, blanc

H 85, Ø 760



54,5W



6500lm



Remote



9 002759 975425

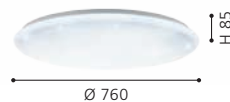

Ø 760

### 97543 GIRON-S

ceiling light; steel, white / plastic with crystal effect, white  
Deckenleuchte; Stahl, weiss / Kunststoff m.Kristalleffekt, weiss  
plafonnier; acier, blanc / plastique avec effet cristal, blanc

H 120, Ø 1000



73W



9800lm



Remote



9 002759 975432

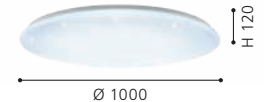

Ø 1000



97871

LED



97872

LED



97873

LED

### 97871 FRANIA

wall / ceiling light; steel, white / plastic, white  
Wand- / Deckenleuchte; Stahl, weiss / Kunststoff, weiss  
applique / plafonnier; acier, blanc / plastique, blanc

H 70, Ø 280

LED

10W

warm  
WHITE

1100lm



### 97872 FRANIA

wall / ceiling light; steel, white / plastic, white  
Wand- / Deckenleuchte; Stahl, weiss / Kunststoff, weiss  
applique / plafonnier; acier, blanc / plastique, blanc

H 70, Ø 330

LED

14,6W

warm  
WHITE

1600lm



### 97873 FRANIA

wall / ceiling light; steel, white / plastic, white  
Wand- / Deckenleuchte; Stahl, weiss / Kunststoff, weiss  
applique / plafonnier; acier, blanc / plastique, blanc

H 70, Ø 430

LED

6x 5,5W

warm  
WHITE

3600lm



9 002759 978716

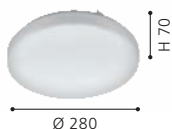

9 002759 978723



9 002759 978730







98446



### 98446 FRANIA

wall / ceiling light; steel, white / plastic, white  
Wand- / Deckenleuchte; Stahl, weiss / Kunststoff, weiss  
applique / plafonnier; acier, blanc / plastique, blanc

H 70, Ø 550



50W 5900lm





97877



97878



97879



### 97877 FRANIA-S

wall / ceiling light; steel, white / plastic with crystal effect, white  
Wand- / Deckenleuchte; Stahl, weiss / Kunststoff m.Kristalleffekt, weiss  
applique / plafonnier; acier, blanc / plastique avec effet cristal, blanc

H 70, Ø 280



10W



1100lm



### 97878 FRANIA-S

wall / ceiling light; steel, white / plastic with crystal effect, white  
Wand- / Deckenleuchte; Stahl, weiss / Kunststoff m.Kristalleffekt, weiss  
applique / plafonnier; acier, blanc / plastique avec effet cristal, blanc

H 70, Ø 330



14,6W



1600lm



### 97879 FRANIA-S

wall / ceiling light; steel, white / plastic with crystal effect, white  
Wand- / Deckenleuchte; Stahl, weiss / Kunststoff m.Kristalleffekt, weiss  
applique / plafonnier; acier, blanc / plastique avec effet cristal, blanc

H 70, Ø 430



6x 5,5W



3600lm



9 002759 978778

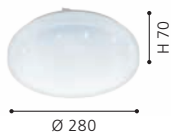

9 002759 978785



9 002759 978792





98448



### 98448 FRANIA-S

wall / ceiling light; steel, white / plastic with crystal effect, white  
Wand- / Deckenleuchte; Stahl, weiss / Kunststoff m. Kristalleffekt, weiss  
applique / plafonnier; acier, blanc / plastique avec effet cristal, blanc

H 70, Ø 550



50W 5900lm

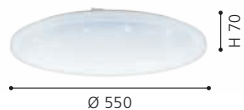



97874



97875



97876



### 97874 FRANIA

wall / ceiling light; steel, white / plastic, white  
Wand- / Deckenleuchte; Stahl, weiss / Kunststoff, weiss  
applique / plafonnier; acier, blanc / plastique, blanc

L 280, B 280, H 70



10W



1100lm



9 002759 978747

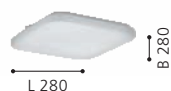

### 97875 FRANIA

wall / ceiling light; steel, white / plastic, white  
Wand- / Deckenleuchte; Stahl, weiss / Kunststoff, weiss  
applique / plafonnier; acier, blanc / plastique, blanc

L 330, B 330, H 70



14,6W



1600lm



9 002759 978754

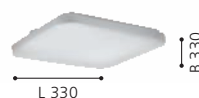

### 97876 FRANIA

wall / ceiling light; steel, white / plastic, white  
Wand- / Deckenleuchte; Stahl, weiss / Kunststoff, weiss  
applique / plafonnier; acier, blanc / plastique, blanc

L 430, B 430, H 70



6x 5,5W



3600lm



9 002759 978761

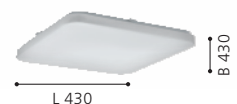





98447

LED

### 98447 FRANIA

wall / ceiling light; steel, white / plastic, white  
Wand- / Deckenleuchte; Stahl, weiss / Kunststoff, weiss  
applique / plafonnier; acier, blanc / plastique, blanc

L 530, B 530, H 70

LED

50W

warm  
WHITE

5900lm





97881



97882



97883



### 97881 FRANIA-S

wall / ceiling light; steel, white / plastic with crystal effect, white  
Wand- / Deckenleuchte; Stahl, weiss / Kunststoff m.Kristalleffekt, weiss  
applique / plafonnier; acier, blanc / plastique avec effet cristal, blanc

L 280, B 280, H 70



10W



1100lm



### 97882 FRANIA-S

wall / ceiling light; steel, white / plastic with crystal effect, white  
Wand- / Deckenleuchte; Stahl, weiss / Kunststoff m.Kristalleffekt, weiss  
applique / plafonnier; acier, blanc / plastique avec effet cristal, blanc

L 330, B 330, H 70



14,6W



1600lm



### 97883 FRANIA-S

wall / ceiling light; steel, white / plastic with crystal effect, white  
Wand- / Deckenleuchte; Stahl, weiss / Kunststoff m.Kristalleffekt, weiss  
applique / plafonnier; acier, blanc / plastique avec effet cristal, blanc

L 430, B 430, H 70



6x 5,5W



3600lm



9 002759 978815

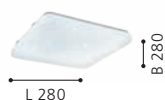

9 002759 978822

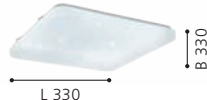

9 002759 978839

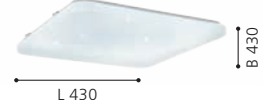



98449

LED

### 98449 FRANIA-S

wall / ceiling light; steel, white / plastic with crystal effect, white

Wand- / Deckenleuchte; Stahl, weiss / Kunststoff m. Kristalleffekt, weiss

applique / plafonnier; acier, blanc / plastique avec effet cristal, blanc

L 530, B 530, H 70

LED

50W

warm  
WHITE

5900lm

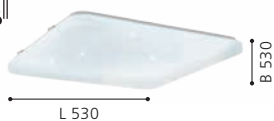



99341

LED

incl./inkl./inclus



99342

LED

incl./inkl./inclus



97577

LED

incl./inkl./inclus



**TUNABLE WHITE**  
2700 - 6500 K

**STEP DIMMING**  
10/25/50/100 %

97577

97578



### 99341 ZAMUDILO

ceiling light; steel, white / plastic with crystal effect, white, silver  
Deckenleuchte; Stahl, weiss / Kunststoff m. Kristalleffekt, weiss, silber  
plafonnier; acier, blanc / plastique avec effet cristal, blanc, argent

H 90, Ø 400



16,5W



1850lm



Remote

### 99342 ZAMUDILO

ceiling light; steel, white / plastic with crystal effect, white, silver  
Deckenleuchte; Stahl, weiss / Kunststoff m. Kristalleffekt, weiss, silber  
plafonnier; acier, blanc / plastique avec effet cristal, blanc, argent

H 90, Ø 500



21,6W



2450lm



Remote

### 97577 SILERAS

wall / ceiling light; steel, white / plastic with crystal effect, white  
Wand- / Deckenleuchte; Stahl, weiss / Kunststoff m. Kristalleffekt, weiss  
applique / plafonnier; acier, blanc / plastique avec effet cristal, blanc

H 85, Ø 450



22,5W



2800lm



Remote



9 002759 993412

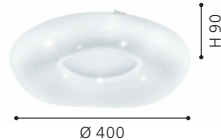

9 002759 993429



9 002759 975777







97578



incl./inkl./inclus



99108



99109



### 97578 SILERAS

wall / ceiling light; steel, white / plastic with crystal effect, white  
Wand- / Deckenleuchte; Stahl, weiss / Kunststoff m. Kristalleffekt, weiss  
applique / plafonnier; acier, blanc / plastique avec effet cristal, blanc

H 85, Ø 600



35W

4400lm

Remote

### 99108 RUIDERA

ceiling light; steel, white / plastic, white, silver  
Deckenleuchte; Stahl, weiss / Kunststoff, weiss, silber  
plafonnier; acier, blanc / plastique, blanc, argent

H 90, Ø 480



22W

2500lm

### 99109 RUIDERA

ceiling light; steel, white / plastic, white, silver  
Deckenleuchte; Stahl, weiss / Kunststoff, weiss, silber  
plafonnier; acier, blanc / plastique, blanc, argent

L 480, B 480, H 90



22W

2500lm



9 002759 975784



9 002759 991081

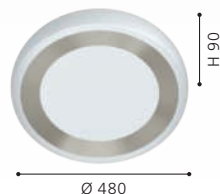

9 002759 991098

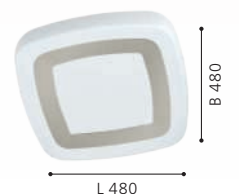



2700 K  
4500 K  
6500 K

95972

95973



96026

LED



**VOLTAGO 2**

These luminaires come with an interesting glitter-effect.

Diese Leuchten sind mit einem interessanten Glitzer-Effekt ausgestattet.

Ces luminaires viennent avec un effet scintillant intéressant.



95972

LED

incl./inkl./inclus



**96026 CAPASSO 1**

wall / ceiling light; steel, white / plastic, white, chrome  
Wand- / Deckenleuchte; Stahl, weiss / Kunststoff, weiss, chrom  
applique / plafonnier; acier, blanc / plastique, blanc, chrome

H 70, Ø 400



20W



2400lm



**95972 VOLTAGO 2**

wall / ceiling light; steel, white / plastic with crystal effect, white  
Wand- / Deckenleuchte; Stahl, weiss / Kunststoff m. Kristalleffekt, weiss  
applique / plafonnier; acier, blanc / plastique avec effet cristal, blanc

H 105, Ø 380



4x 4,8W



1920lm



Remote



**95973 VOLTAGO 2**

wall / ceiling light; steel, white / plastic with crystal effect, white  
Wand- / Deckenleuchte; Stahl, weiss / Kunststoff m. Kristalleffekt, weiss  
applique / plafonnier; acier, blanc / plastique avec effet cristal, blanc

H 125, Ø 580



4x 8,2W



3800lm



Remote



9 002759 960261



9 002759 959722



9 002759 959739





95973

LED

incl./inkl./inclus





97738

LED

incl./inkl./inclus



98323

LED

incl./inkl./inclus



98324

LED

incl./inkl./inclus



TUNABLE  
WHITE



DIMMABLE

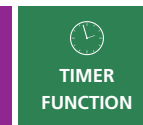

TIMER  
FUNCTION

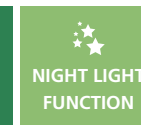

NIGHT LIGHT  
FUNCTION

10 - 100 %

off after 30sec.

98323

98324

97737

97738

### 97738 LANCIANO

ceiling light; steel, white, transparent / plastic with crystal effect, white, silver

Deckenleuchte; Stahl, weiss, transparent / Kunststoff m.Kristalleffekt, weiss, silber

plafonnier; acier, blanc, transparent / plastique avec effet cristal, blanc, argent

H 105, Ø 860



56W



6800lm



Remote

### 98323 LANCIANO 1

wall / ceiling light; steel, white, transparent / plastic with crystal effect, white, chrome

Wand- / Deckenleuchte; Stahl, weiss, transparent / Kunststoff m.Kristalleffekt, weiss, chrom

applique / plafonnier; acier, blanc, transparent / plastique avec effet cristal, blanc, chrome

H 75, Ø 400



24W



1900lm



Remote

### 98324 LANCIANO 1

wall / ceiling light; steel, white, transparent / plastic with crystal effect, white, chrome

Wand- / Deckenleuchte; Stahl, weiss, transparent / Kunststoff m.Kristalleffekt, weiss, chrom

applique / plafonnier; acier, blanc, transparent / plastique avec effet cristal, blanc, chrome

H 80, Ø 560



33W



4000lm



Remote



9 002759 977382

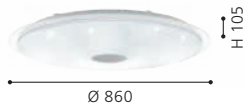

9 002759 983239

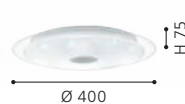

9 002759 983246







97737



incl./inkl./inclus



900598



incl./inkl./inclus



900599



incl./inkl./inclus



### 97737 LANCIANO

ceiling light; steel, plastic, white, transparent / plastic with crystal effect, white, silver  
 Deckenleuchte; Stahl, Kunststoff, weiss, transparent / Kunststoff m. Kristalleffekt, weiss, silber  
 plafonnier; acier, plastique, blanc, transparent / plastique avec effet cristal, blanc, argent  
 H 100, Ø 660



36W

4300lm

Remote

### 900598 LANCIANO 1

ceiling light; steel, wood, white, brown / plastic, white  
 Deckenleuchte; Stahl, Holz, weiss, braun / Kunststoff, weiss  
 plafonnier; acier, bois, blanc, marron / plastique, blanc

H 70, Ø 380



24W

2600lm

### 900599 LANCIANO 1

ceiling light; steel, wood, white, brown / plastic, white  
 Deckenleuchte; Stahl, Holz, weiss, braun / Kunststoff, weiss  
 plafonnier; acier, bois, blanc, marron / plastique, blanc

H 80, Ø 480



35W

4000lm



9 002759 977375



9 008606 244973

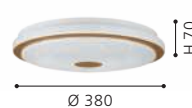

9 008606 244980

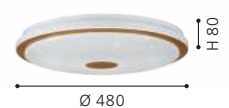



900608

LED



900607

LED

### 900608 FERENTINO

ceiling light; steel, white / plastic, white  
Deckenleuchte; Stahl, weiss / Kunststoff, weiss  
plafonnier; acier, blanc / plastique, blanc

H 60, Ø 380



19,5W 2300lm

### 900607 FERENTINO

ceiling light; steel, white / plastic, white  
Deckenleuchte; Stahl, weiss / Kunststoff, weiss  
plafonnier; acier, blanc / plastique, blanc

H 60, Ø 280



10W 1100lm



9 008606 245062

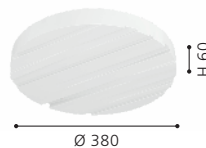

9 008606 245055

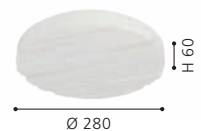



900609



900611



### 900609 FERENTINO

ceiling light; steel, white / plastic, white  
Deckenleuchte; Stahl, weiss / Kunststoff, weiss  
plafonnier; acier, blanc / plastique, blanc

L 280, B 280, H 60



10W 1100lm



9 008606 245079

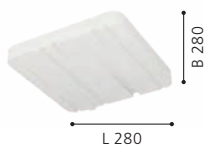

### 900611 FERENTINO

ceiling light; steel, white / plastic, white  
Deckenleuchte; Stahl, weiss / Kunststoff, weiss  
plafonnier; acier, blanc / plastique, blanc

L 330, B 330, H 60



14,6W 1600lm



9 008606 245086





900605

LED

incl./inkl./inclus



900606

LED

incl./inkl./inclus



**900605 BATTISTONA**

ceiling light; steel, white / plastic, white  
 Deckenleuchte; Stahl, weiss / Kunststoff, weiss  
 plafonnier; acier, blanc / plastique, blanc

H 85, Ø 380



**900606 BATTISTONA**

ceiling light; steel, white / plastic, white  
 Deckenleuchte; Stahl, weiss / Kunststoff, weiss  
 plafonnier; acier, blanc / plastique, blanc

H 100, Ø 480



9 008606 245031

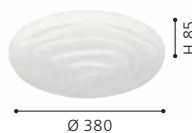

9 008606 245048

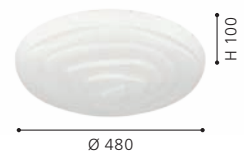





99343

LED



99465

LED



99344

LED

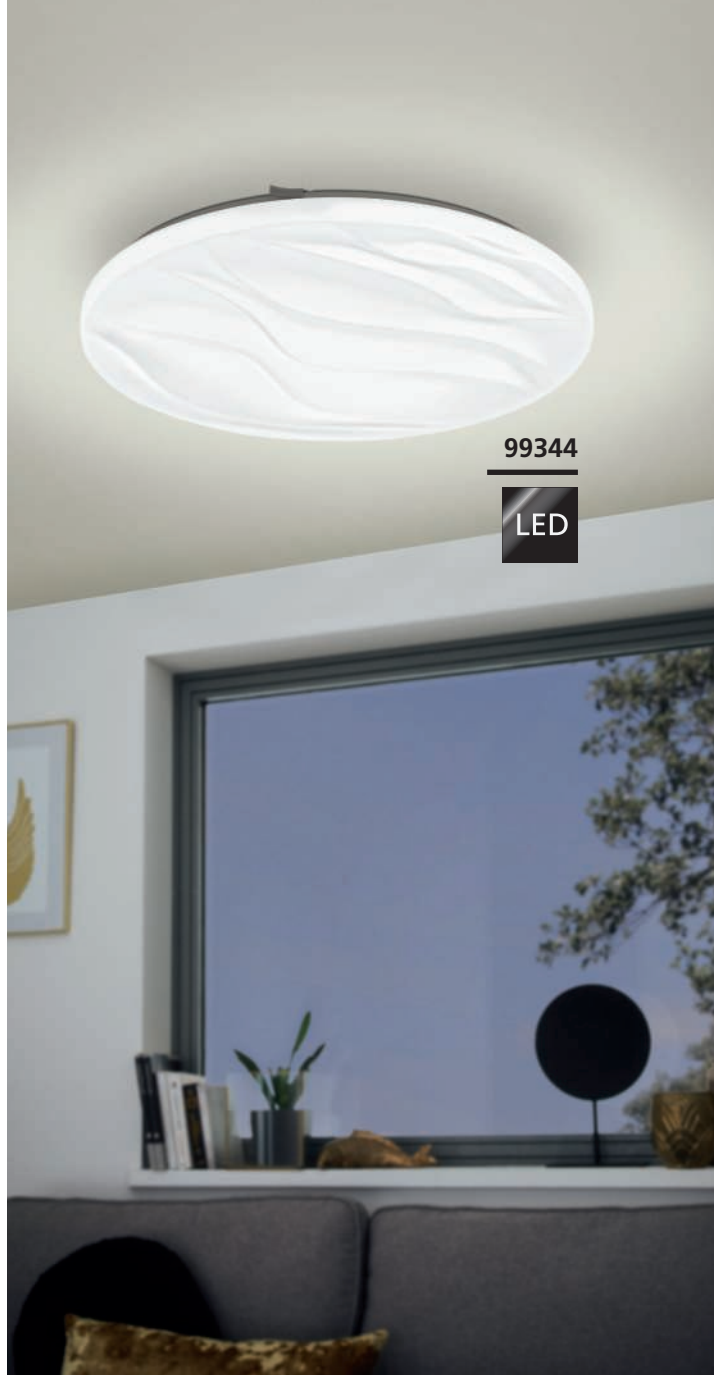

### 99343 BENARIBA

wall / ceiling light; steel, white / plastic, white  
Wand- / Deckenleuchte; Stahl, weiss / Kunststoff, weiss  
applique / plafonnier; acier, blanc / plastique, blanc

H 65, Ø 330



14,6W 1600lm

### 99465 BENARIBA

wall / ceiling light; steel, white / plastic, white  
Wand- / Deckenleuchte; Stahl, weiss / Kunststoff, weiss  
applique / plafonnier; acier, blanc / plastique, blanc

H 70, Ø 550



8x 4,4W 4240lm

### 99344 BENARIBA

wall / ceiling light; steel, white / plastic, white  
Wand- / Deckenleuchte; Stahl, weiss / Kunststoff, weiss  
applique / plafonnier; acier, blanc / plastique, blanc

H 70, Ø 440



22W 2500lm



9 002759 993436



9 002759 994655

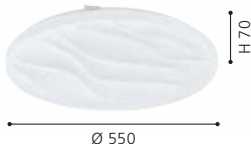

9 002759 993443





95677

LED





95679



### 95677 COMPETA 1

wall / ceiling light; steel, white / plastic, white, silver, clear  
 Wand- / Deckenleuchte; Stahl, weiss / Kunststoff, weiss, silber, klar  
 applique / plafonnier; acier, blanc / plastique, blanc, argent, transparent

H 75, Ø 335



15,6W 1900lm

### 95679 COMPETA 1

wall / ceiling light; steel, white / plastic, white, silver, clear  
 Wand- / Deckenleuchte; Stahl, weiss / Kunststoff, weiss, silber, klar  
 applique / plafonnier; acier, blanc / plastique, blanc, argent, transparent

L 340, B 340, H 80



21W 2400lm



9 002759 956776



9 002759 956790

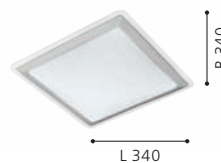



96032



96033



96034



### 96032 COMPETA 1

wall / ceiling light; steel, white / plastic, white, satined nickel  
Wand- / Deckenleuchte; Stahl, weiss / Kunststoff, weiss, nickel-  
matt  
applique / plafonnier; acier, blanc / plastique, blanc, nickel mat

H 55, Ø 245



15,6W 1900lm

### 96033 COMPETA 1

wall / ceiling light; steel, white / plastic, white, satined nickel  
Wand- / Deckenleuchte; Stahl, weiss / Kunststoff, weiss, nickel-  
matt  
applique / plafonnier; acier, blanc / plastique, blanc, nickel mat

H 55, Ø 325



18W 2200lm

### 96034 COMPETA 1

wall / ceiling light; steel, white / plastic, white, satined nickel  
Wand- / Deckenleuchte; Stahl, weiss / Kunststoff, weiss, nickel-  
matt  
applique / plafonnier; acier, blanc / plastique, blanc, nickel mat

H 55, Ø 430



20W 2400lm



9 002759 960322



9 002759 960339



9 002759 960346







95682



95684



### 95682 PALERMO 2

wall / ceiling light; steel, white / plastic, white, chrome  
 Wand- / Deckenleuchte; Stahl, weiss / Kunststoff, weiss, chrom  
 applique / plafonnier; acier, blanc / plastique, blanc, chrome

H 70, Ø 280



15,6W 1900lm

### 95684 PALERMO 2

wall / ceiling light; steel, white / plastic, white, chrome  
 Wand- / Deckenleuchte; Stahl, weiss / Kunststoff, weiss, chrom  
 applique / plafonnier; acier, blanc / plastique, blanc, chrome

H 60, Ø 410



20W 2400lm



9 002759 956820



9 002759 956844





96023



900149



900335



### 96023 CAPASSO

wall / ceiling light; steel, white / plastic, white, chrome  
Wand- / Deckenleuchte; Stahl, weiss / Kunststoff, weiss, chrom  
applique / plafonnier; acier, blanc / plastique, blanc, chrome

H 65, Ø 340

LED

warm  
WHITE  
2200lm



9 002759 960230



### 900149 CAPASSO

wall / ceiling light; steel, white / plastic, white, black  
Wand- / Deckenleuchte; Stahl, weiss / Kunststoff, weiss, schwarz  
applique / plafonnier; acier, blanc / plastique, blanc, noir

H 60, Ø 340

LED

warm  
WHITE  
1600lm



9 008606 243471

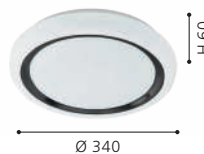

### 900335 CAPASSO

wall / ceiling light; steel, white / plastic, white, black  
Wand- / Deckenleuchte; Stahl, weiss / Kunststoff, weiss, schwarz  
applique / plafonnier; acier, blanc / plastique, blanc, noir

H 60, Ø 480

LED

warm  
WHITE  
2200lm



9 008606 243488

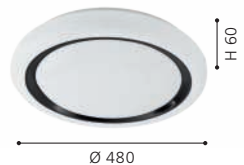



900612



900613



### 900612 RENDE

ceiling light; steel, white / plastic, white, gold  
Deckenleuchte; Stahl, weiss / Kunststoff, weiss, gold  
plafonnier; acier, blanc / plastique, blanc, or

H 60, Ø 380



19,5W 2300lm

### 900613 RENDE

ceiling light; steel, white / plastic, white, silver  
Deckenleuchte; Stahl, weiss / Kunststoff, weiss, silber  
plafonnier; acier, blanc / plastique, blanc, argent

L 380, B 380, H 60



19,5W 2300lm



9 008606 245093



9 008606 245109





900498

LED



900499

LED



900501

LED



### 900498 NIEVES 1

wall / ceiling light; steel, white / plastic, white, gold  
Wand- / Deckenleuchte; Stahl, weiss / Kunststoff, weiss, gold  
applique / plafonnier; acier, blanc / plastique, blanc, or

H 60, Ø 310

LED

warm  
WHITE  
1100lm



10W

1100lm

### 900499 NIEVES 1

wall / ceiling light; steel, white / plastic, white, gold  
Wand- / Deckenleuchte; Stahl, weiss / Kunststoff, weiss, gold  
applique / plafonnier; acier, blanc / plastique, blanc, or

H 65, Ø 410

LED

warm  
WHITE  
2300lm



19,5W

2300lm

### 900501 NIEVES 1

wall / ceiling light; steel, white / plastic, white, gold  
Wand- / Deckenleuchte; Stahl, weiss / Kunststoff, weiss, gold  
applique / plafonnier; acier, blanc / plastique, blanc, or

H 70, Ø 510

LED

warm  
WHITE  
3710lm



7x 4,4W

3710lm



9 008606 239634

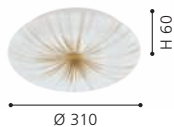

9 008606 239641



9 008606 239658







99699

LED



98325

LED



98326

LED

### 99699 NIEVES

wall / ceiling light; steel, white / plastic, white, silver  
Wand- / Deckenleuchte; Stahl, weiss / Kunststoff, weiss, silber  
applique / plafonnier; acier, blanc / plastique, blanc, argent

H 60, Ø 310



10W 1100lm

### 98325 NIEVES

wall / ceiling light; steel, white / plastic, white, silver  
Wand- / Deckenleuchte; Stahl, weiss / Kunststoff, weiss, silber  
applique / plafonnier; acier, blanc / plastique, blanc, argent

H 65, Ø 410



19,5W 2300lm

### 98326 NIEVES

wall / ceiling light; steel, white / plastic, white, silver  
Wand- / Deckenleuchte; Stahl, weiss / Kunststoff, weiss, silber  
applique / plafonnier; acier, blanc / plastique, blanc, argent

H 70, Ø 510



7x 4,4W 3710lm



9 002759 996994

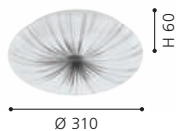

9 002759 983253

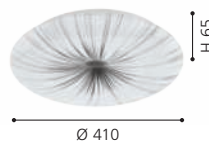

9 002759 983260

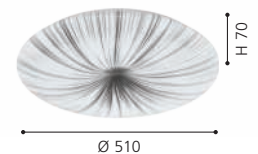



99406



99407



98603



### 99406 PESCAITO

wall / ceiling light; steel, black / plastic, white, gold  
Wand- / Deckenleuchte; Stahl, schwarz / Kunststoff, weiss, gold  
applique / plafonnier; acier, noir / plastique, blanc, or

H 65, Ø 280



10W 1100lm



9 002759 994068

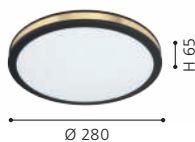

### 99407 PESCAITO

wall / ceiling light; steel, black / plastic, white, gold  
Wand- / Deckenleuchte; Stahl, schwarz / Kunststoff, weiss, gold  
applique / plafonnier; acier, noir / plastique, blanc, or

H 65, Ø 380



19,5W 2300lm



9 002759 994075

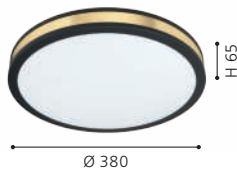

### 98603 MUSURITA

ceiling light; plastic, steel, black / plastic, white  
Deckenleuchte; Kunststoff, Stahl, schwarz / Kunststoff, weiss  
plafonnier; plastique, acier, noir / plastique, blanc

H 60, Ø 340



14,6W 1600lm



9 002759 986032





98604



98602



98601

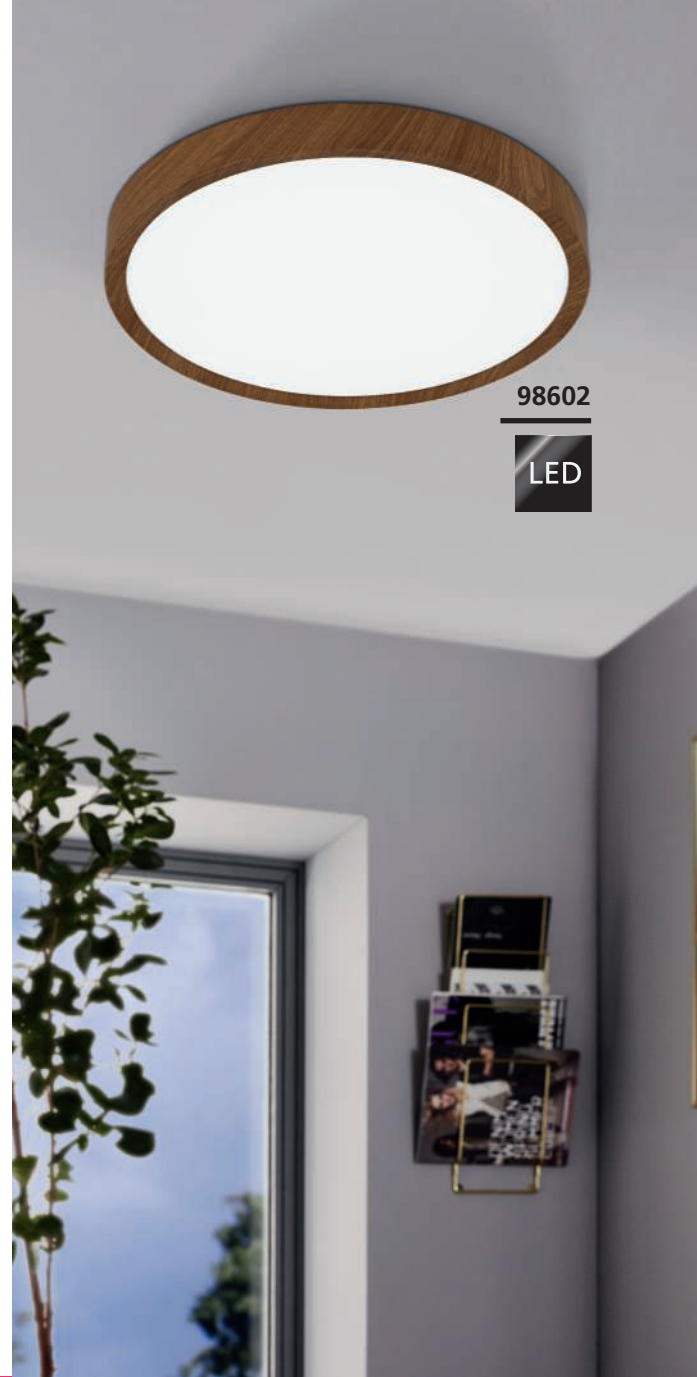

### 98604 MUSURITA

ceiling light; plastic, steel, black / plastic, white  
Deckenleuchte; Kunststoff, Stahl, schwarz / Kunststoff, weiss  
plafonnier; plastique, acier, noir / plastique, blanc

H 75, Ø 440



6x 5,5 W 3600 lm

### 98601 MUSURITA

ceiling light; plastic, steel, natural wood look / plastic, white  
Deckenleuchte; Kunststoff, Stahl, Holzoptik natur / Kunststoff, weiss  
plafonnier; plastique, acier, aspect bois naturel / plastique, blanc

H 60, Ø 340



14,6 W 1600 lm

### 98602 MUSURITA

ceiling light; plastic, steel, natural wood look / plastic, white  
Deckenleuchte; Kunststoff, Stahl, Holzoptik natur / Kunststoff, weiss  
plafonnier; plastique, acier, aspect bois naturel / plastique, blanc

H 75, Ø 440



6x 5,5 W 3600 lm



9 002759 986049

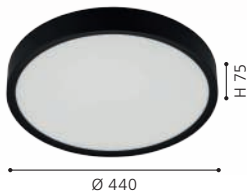

9 002759 986018



9 002759 986025





99782

LED

incl./inkl./inclus



99783

LED

incl./inkl./inclus



99779

LED

incl./inkl./inclus



### 99782 LAURITO

ceiling light; steel, white / plastic, grey, white  
Deckenleuchte; Stahl, weiss / Kunststoff, grau, weiss  
plafonnier; acier, blanc / plastique, gris, blanc

H 70, Ø 490

LED

24W

tunable  
WHITE

2600lm



CONTROL  
UNIT

Remote

### 99783 LAURITO

ceiling light; steel, white / plastic, black, white  
Deckenleuchte; Stahl, weiss / Kunststoff, schwarz, weiss  
plafonnier; acier, blanc / plastique, noir, blanc

H 70, Ø 490

LED

24W

tunable  
WHITE

2600lm



CONTROL  
UNIT

Remote

### 99779 SELUCI

ceiling light; steel, white / plastic, white, clear  
Deckenleuchte; Stahl, weiss / Kunststoff, weiss, klar  
plafonnier; acier, blanc / plastique, blanc, transparent

H 80, Ø 490

LED

4x 10W

tunable  
WHITE

4600lm



CONTROL  
UNIT

Remote



9 002759 997823



9 002759 997830



9 002759 997793







99781

LED

incl./inkl./inclus



### 99781 SELUCI

ceiling light; steel, black / plastic, white, clear  
Deckenleuchte; Stahl, schwarz / Kunststoff, weiss, klar  
plafonnier; acier, noir / plastique, blanc, transparent

H 80, Ø 490

LED

4x 10W

tunable  
WHITE

4600lm



CONTROL  
UNIT

Remote



9 002759 997816



### SELUCI

Convenient light effect due to the indirect illumination.

Angenehmer Lichteffect durch indirekte Beleuchtung.

Effet de lumière pratique en raison de l'éclairage indirect.



99623

LED



99621

LED



99622

LED

### 99623 VALCASOTTO

ceiling light; steel, Mokka colour / plastic, white  
 Deckenleuchte; Stahl, Mokkafarben / Kunststoff, weiss  
 plafonnier; acier, café / plastique, blanc

H 75, Ø 370

LED

warm  
WHITE  
2500lm



24W

2500lm



### 99621 VALCASOTTO

ceiling light; steel, black / plastic, white  
 Deckenleuchte; Stahl, schwarz / Kunststoff, weiss  
 plafonnier; acier, noir / plastique, blanc

H 75, Ø 370

LED

warm  
WHITE  
2500lm



21,6W

2500lm

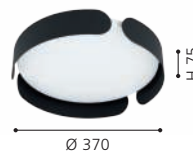

### 99622 VALCASOTTO

ceiling light; steel, brown / plastic, white  
 Deckenleuchte; Stahl, braun / Kunststoff, weiss  
 plafonnier; acier, marron / plastique, blanc

H 75, Ø 370

LED

warm  
WHITE  
2500lm



24W

2500lm





900463



900464



### 900463 LUPPINERIA

ceiling light; steel, plastic, sandy, white / wood, brown  
Deckenleuchte; Stahl, Kunststoff, sandfarben, weiss / Holz, braun  
plafonnier; acier, plastique, couleur sable, blanc / bois, marron

H 80, Ø 380



24W 2500lm



9 008606 244027



### 900464 LUPPINERIA

ceiling light; plastic, steel, white / wood, brown  
Deckenleuchte; Kunststoff, Stahl, weiss / Holz, braun  
plafonnier; plastique, acier, blanc / bois, marron

H 80, Ø 380



24W 2500lm



9 008606 244034

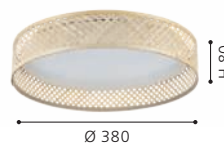





99703



99704



**99703 PENJAMO**

ceiling light; steel, black / plastic with crystal effect, white  
 Deckenleuchte; Stahl, schwarz / Kunststoff m. Kristalleffekt, weiss  
 plafonnier; acier, noir / plastique avec effet cristal, blanc

H 60, Ø 465



3x 7,3W 2010lm

**99704 PENJAMO**

ceiling light; steel, Mokka colour / plastic with crystal effect, white  
 Deckenleuchte; Stahl, Mokkafarben / Kunststoff m. Kristalleffekt, weiss  
 plafonnier; acier, café / plastique avec effet cristal, blanc

H 60, Ø 465



3x 7,3W 2010lm



9 002759 997038



9 002759 997045







900601



900602



### 900601 CALAGRANO

ceiling light; steel, black / plastic, white  
Deckenleuchte; Stahl, schwarz / Kunststoff, weiss  
plafonnier; acier, noir / plastique, blanc

H 60, Ø 380



9 008606 244997



### 900602 CALAGRANO

ceiling light; steel, black / plastic, white  
Deckenleuchte; Stahl, schwarz / Kunststoff, weiss  
plafonnier; acier, noir / plastique, blanc

L 375, B 375, H 60



9 008606 245000

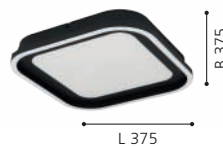



99397



99397

The wall switch controls the luminaire's light colour.

Über den Wandschalter kann die Lichtfarbe der Leuchte gesteuert werden.

La couleur de lumière du luminaire peut être commandée par l'interrupteur mural.



99398



99398

The wall switch controls the luminaire's light colour.

Über den Wandschalter kann die Lichtfarbe der Leuchte gesteuert werden.

La couleur de lumière du luminaire peut être commandée par l'interrupteur mural.

### 99397 MENTALURGIA

wall / ceiling light; steel, white, chrome / plastic, white  
Wand- / Deckenleuchte; Stahl, weiss, chrom / Kunststoff, weiss  
applique / plafonnier; acier, blanc, chrome / plastique, blanc

L 495, B 465, H 65



9 002759 993979



### 99398 MENTALURGIA

wall / ceiling light; steel, white, chrome / plastic, white  
Wand- / Deckenleuchte; Stahl, weiss, chrom / Kunststoff, weiss  
applique / plafonnier; acier, blanc, chrome / plastique, blanc

L 490, B 490, H 65



9 002759 993986

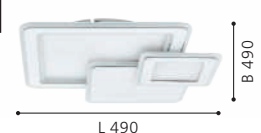

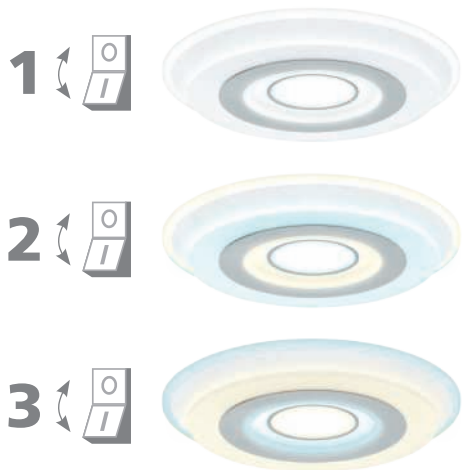

99399



### 99399

The wall switch controls the luminaire's light colour.

Über den Wandschalter kann die Lichtfarbe der Leuchte gesteuert werden.

La couleur de lumière du luminaire peut être commandée par l'interrupteur mural.

### 99399 REDUCTA 2

wall / ceiling light; plastic, white  
Wand- / Deckenleuchte; Kunststoff, weiss  
applique / plafonnier; plastique, blanc

H 45, Ø 490

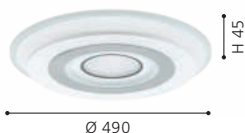



**81635**



**83404**



**81636**

### 81635 ELLA

wall / ceiling light; steel, white / glass opal-matt, white  
Wand- / Deckenleuchte; Stahl, weiss / Glas opal-matt, weiss  
applique / plafonnier; acier, blanc / verre opale mat, blanc

H 92, Ø 200



E27



1x 60W

### 81636 ELLA

wall / ceiling light; steel, white / glass opal-matt, white  
Wand- / Deckenleuchte; Stahl, weiss / Glas opal-matt, weiss  
applique / plafonnier; acier, blanc / verre opale mat, blanc

H 117, Ø 280



E27



1x 60W

### 83404 ELLA

wall / ceiling light; steel, white / glass opal-matt, white  
Wand- / Deckenleuchte; Stahl, weiss / Glas opal-matt, weiss  
applique / plafonnier; acier, blanc / verre opale mat, blanc

H 127, Ø 350



E27



2x 60W



9 002759 816353

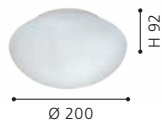

9 002759 816360



9 002759 834043







94973

### 94973 DURELO

ceiling light; plastic, white / glass, white  
Deckenleuchte; Kunststoff, weiss / Glas, weiss  
plafonnier; plastique, blanc / verre, blanc

H 195, Ø 160



E27



1x 28W



9 002759 949730





**82942**



**83155**

**82942 PLANET**

wall / ceiling light; steel, satin nickel / satin glass, white, clear  
Wand- / Deckenleuchte; Stahl, nickel-matt / Glas satiniert, weiss, klar  
applique / plafonnier; acier, nickel mat / verre satiné, blanc, transparent

H 85, Ø 290



E27



1x 25W

**83155 PLANET 1**

wall / ceiling light; steel, chrome / glass painted, white, clear  
Wand- / Deckenleuchte; Stahl, chrom / Glas lackiert, weiss, klar  
applique / plafonnier; acier, chrome / verre laqué, blanc, transparent

H 85, Ø 290



E27



1x 25W



9 002759 829421



Ø 290



9 002759 831554



Ø 290



**83156**



**83154**



**83153**

### 83156 PLANET 1

wall light; steel, chrome / glass painted, white, clear  
Wandleuchte; Stahl, chrom / Glas lackiert, weiss, klar  
applique; acier, chrome / verre laqué, blanc, transparent

L 290, H 145, A 85



E27 1x 60W



9 002759 831561



### 83153 PLANET 1

wall / ceiling light; steel, white / glass painted, white, clear  
Wand- / Deckenleuchte; Stahl, weiss / Glas lackiert, weiss, klar  
applique / plafonnier; acier, blanc / verre laqué, blanc, transparent

H 85, Ø 290



E27 1x 25W



9 002759 831530



### 83154 PLANET 1

wall light; steel, white / glass painted, white, clear  
Wandleuchte; Stahl, weiss / Glas lackiert, weiss, klar  
applique; acier, blanc / verre laqué, blanc, transparent

L 290, H 145, A 85



E27 1x 60W



9 002759 831547





**83157**



**83159**

### 83157 PLANET 1

wall / ceiling light; steel, brass / glass painted, white, clear  
Wand- / Deckenleuchte; Stahl, messing / Glas lackiert, weiss, klar  
applique / plafonnier; acier, laiton / verre laqué, blanc, transparent

H 85, Ø 290



E27



1x 25W



9 002759 831578



Ø 290

### 83159 PLANET 1

wall / ceiling light; steel, black / glass painted, white, clear  
Wand- / Deckenleuchte; Stahl, schwarz / Glas lackiert, weiss, klar  
applique / plafonnier; acier, noir / verre laqué, blanc, transparent

H 85, Ø 290



E27



1x 25W



9 002759 831592



Ø 290

### 83162 PLANET 1

wall / ceiling light; steel, satin nickel / glass painted, white, clear  
Wand- / Deckenleuchte; Stahl, nickel-matt / Glas lackiert, weiss, klar  
applique / plafonnier; acier, nickel mat / verre laqué, blanc, transparent

H 85, Ø 290



E27



1x 25W



9 002759 831622



Ø 290





**83162**



**83163**

### 83163 PLANET 1

wall light; steel, satin nickel / glass painted, white, clear  
Wandleuchte; Stahl, nickel-matt / Glas lackiert, weiss, klar  
applique; acier, nickel mat / verre laqué, blanc, transparent

L 290, H 145, A 85



E27



1x 60W



9 002759 831639





96117

LED





96111

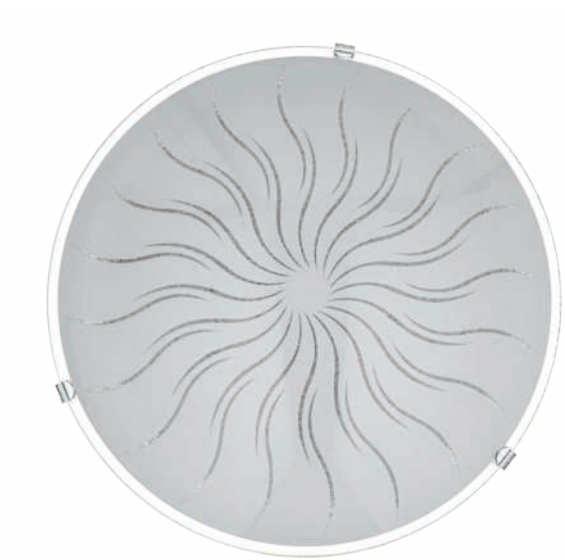

96089



### 96117 MARGITTA 1

wall / ceiling light; steel, white / glass, white, black, clear  
Wand- / Deckenleuchte; Stahl, weiss / Glas, weiss, schwarz, klar  
applique / plafonnier; acier, blanc / verre, blanc, noir, transparent

H 95, Ø 315



3x 11 W  
3x  
950lm



9 002759 961176



Ø 315

### 96089 MARGITTA 1

wall / ceiling light; steel, white / glass, granille white, clear  
Wand- / Deckenleuchte; Stahl, weiss / Glas, granille weiss, klar  
applique / plafonnier; acier, blanc / verre, blanc granille, transparent

H 70, Ø 250



3x 11 W  
3x  
950lm



9 002759 960896



Ø 250

### 96111 MARGITTA 1

wall / ceiling light; steel, white / glass, granille white, clear  
Wand- / Deckenleuchte; Stahl, weiss / Glas, granille weiss, klar  
applique / plafonnier; acier, blanc / verre, blanc granille, transparent

H 95, Ø 315



3x 11 W  
3x  
950lm



9 002759 961114



Ø 315





**89248**



**89239**

### 89248 MARS 1

wall / ceiling light; steel, white / satin glass, white, silver  
 Wand- / Deckenleuchte; Stahl, weiss / Glas satiniert, weiss, silber  
 applique / plafonnier; acier, blanc / verre satiné, blanc, argent

H 70, Ø 250



E27



1x 25W



9 002759 892487



Ø 250

### 89239 MARS 1

wall / ceiling light; steel, white / satin glass, design "beams"  
 Wand- / Deckenleuchte; Stahl, weiss / Glas satiniert, Motiv  
 Strahlen  
 applique / plafonnier; acier, blanc / verre satiné, motif «rayons»

H 70, Ø 250



E27



1x 25W



9 002759 892395

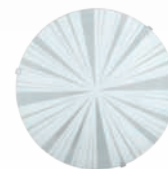

Ø 250





**80263**



**80264**



**89238**

### 80264 MARS

wall / ceiling light; steel, white / satin glass, design "leaves"  
 Wand- / Deckenleuchte; Stahl, weiss / Glas satiniert, Motiv Blätter  
 applique / plafonnier; acier, blanc / verre satiné, motif «feuilles»

H 70, Ø 250



9 002759 802646



Ø 250

### 80263 MARS

wall / ceiling light; steel, white / satin glass, design "triangles"  
 Wand- / Deckenleuchte; Stahl, weiss / Glas satiniert, Motiv Dreiecke  
 applique / plafonnier; acier, blanc / verre satiné, motif «triangles»

H 70, Ø 250



9 002759 802639



Ø 250

### 89238 MARS 1

wall / ceiling light; steel, white / satin glass, design "rose"  
 Wand- / Deckenleuchte; Stahl, weiss / Glas satiniert, Motiv Rose  
 applique / plafonnier; acier, blanc / verre satiné, motif «rose»

H 70, Ø 250



9 002759 892388



Ø 250



DESIGN  
HIGHLIGHT  
DETAIL



95672

LED



90043

### 95672 MAGITTA 1

wall / ceiling light; steel, white / glass, white, clear  
Wand- / Deckenleuchte; Stahl, weiss / Glas, weiss, klar  
applique / plafonnier; acier, blanc / verre, blanc, transparent

H 80, Ø 250

LED

warm  
WHITE



3x 11 W

3x  
950 lm

### 90043 SCALEA 1

wall / ceiling light; steel, white / satin glass, white with decor  
Wand- / Deckenleuchte; Stahl, weiss / Glas satiniert, weiss  
m.Dekor  
applique / plafonnier; acier, blanc / verre satiné, blanc avec décor

H 100, Ø 315



E27

1x 25 W

### 89758 RAYA

wall / ceiling light; steel, white, chrome / satin glass, white, silver  
Wand- / Deckenleuchte; Stahl, weiss, chrom / Glas satiniert,  
weiss, silber  
applique / plafonnier; acier, blanc, chrome / verre satiné, blanc,  
argent

H 100, Ø 315



E27

1x 25 W



9 002759 956721



Ø 250



9 002759 900434



Ø 315



9 002759 897581



Ø 315

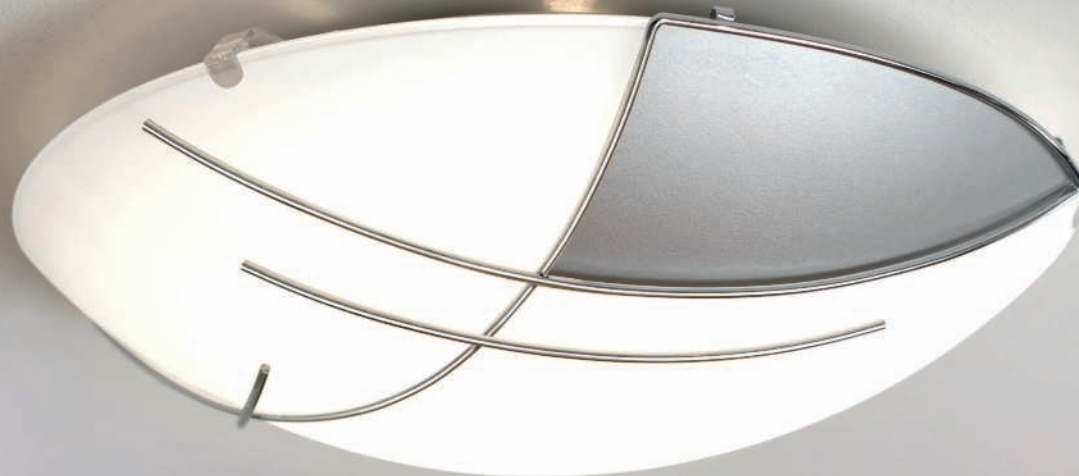

89758





**83132**



**84028**

### 83132 GRAFIK

wall / ceiling light; steel / satin glass, design "lines"  
Wand- / Deckenleuchte; Stahl / Glas satiniert, Motiv Linien  
applique / plafonnier; acier / verre satiné, motif «lignes»

L 180, H 210, A 85



E27



1x 60W



9 002759 831325

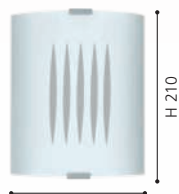

L 180

H 210

### 84028 GRAFIK

wall / ceiling light; steel, silver / satin glass, white  
Wand- / Deckenleuchte; Stahl, silber / Glas satiniert, weiss  
applique / plafonnier; acier, argent / verre satiné, blanc

L 180, H 210, A 85



E27



1x 60W



9 002759 840280

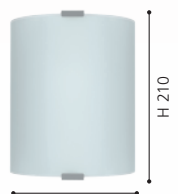

L 180

H 210

### 83119 NEMO

wall light; steel, satin nickel / glass opal-matt, white  
Wandleuchte; Stahl, nickel-matt / Glas opal-matt, weiss  
applique; acier, nickel mat / verre opale mat, blanc

L 150, H 320, A 95



E27



1x 25W



9 002759 831196



L 150

H 320





83119



**80265**



**7186**



**7184**

### 80265 MARS

wall / ceiling light; steel, white / satin glass, white  
Wand- / Deckenleuchte; Stahl, weiss / Glas satiniert, weiss  
applique / plafonnier; acier, blanc / verre satiné, blanc

H 70, Ø 250



E27



1x 25W



9 002759 802653



Ø 250

### 7186 SALOME

wall / ceiling light; steel, chrome / glass alabaster, white  
Wand- / Deckenleuchte; Stahl, chrom / Glas alabaster, weiss  
applique / plafonnier; acier, chrome / verre albâtre, blanc

H 90, Ø 300



E27



1x 25W



9 002759 718602



Ø 300

### 7184 SALOME

wall / ceiling light; steel, chrome / glass alabaster, white  
Wand- / Deckenleuchte; Stahl, chrom / Glas alabaster, weiss  
applique / plafonnier; acier, chrome / verre albâtre, blanc

H 110, Ø 400



E27



2x 25W



9 002759 718404



Ø 400



7188

### 7188 SALOME

wall light; steel, chrome / glass alabaster, white  
Wandleuchte; Stahl, chrom / Glas alabaster, weiss  
applique; acier, chrome / verre albâtre, blanc

L 300, H 150, A 90



E27



1x 60W



9 002759 718800



### SALOME

These luminaires have a beautiful alabaster glass.

Diese Leuchten besitzen ein wunderschönes Alabasterglas.

Ces luminaires ont un beau verre d'albâtre.





DESIGN  
HIGHLIGHT  
DETAIL



82741



86712

### 86712 MESTRE

wall / ceiling light; steel, antique-brown, gold / glass chalked, beige  
Wand- / Deckenleuchte; Stahl, antik-braun, gold / Glas gekalkt, beige  
applique / plafonnier; acier, marron antique, or / verre chaulé, beige  
H 133, Ø 395



E27 2x 60W

### 82741 IMPERIAL

wall / ceiling light; cast metal, bronzed / satin glass, white  
Wand- / Deckenleuchte; Metallguss, brüniert / Glas satiniert, weiss  
applique / plafonnier; fonte métallique, brun / verre satiné, blanc

H 140, Ø 310



E27 2x 25W



9 002759 867126



9 002759 827410







**89115**



**86715**



**87793**

### 89115 ALMERA

wall light; steel, antique-brown / glass, champagne  
Wandleuchte; Stahl, antik-braun / Glas, champagner  
applique; acier, marron antique / verre, champagne

L 180, H 250, A 75



### 86715 MESTRE

wall light; steel, antique-brown, gold / glass chalked, beige  
Wandleuchte; Stahl, antik-braun, gold / Glas gekalkt, beige  
applique; acier, marron antique, or / verre chaulé, beige

L 300, H 335, A 160



### 87793 PASCAL 1

wall light; steel, antique-brown / glass chalked, beige  
Wandleuchte; Stahl, antik-braun / Glas gekalkt, beige  
applique; acier, marron antique / verre chaulé, beige

L 180, H 480, A 120





**90737**

**90737, 90697**

Rustic luminaire series with appealing leaf decor

Rustikale Leuchtenserie mit ansprechendem Blätterdekor

Série de luminaires rustique avec un décor de feuille plaisant



**90697**

### 90737 CAMPANIA

ceiling light; steel, antique-brown, gold / glass chalked, white  
Deckenleuchte; Stahl, antik-braun, gold / Glas gekalkt, weiss  
plafonnier; acier, marron antique, or / verre chaulé, blanc

H 115, Ø 775



G4 15x 10W

### 90697 GERBERA 1

ceiling light; steel, antique-brown, gold / satin glass, white  
Deckenleuchte; Stahl, antik-braun, gold / Glas satiniert, weiss  
plafonnier; acier, marron antique, or / verre satiné, blanc

H 90, Ø 780



G9 6x 33W

### 92143 COLTI

ceiling light; steel, antique-brown / satin glass, white painted  
Deckenleuchte; Stahl, antik-braun / Glas satiniert, weiss lackiert  
plafonnier; acier, marron antique / verre satiné, blanc laqué

H 95, Ø 350



E27 2x 25W



9 002759 907372



9 002759 906979

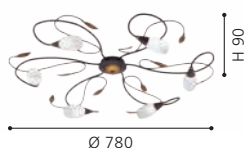

9 002759 921439

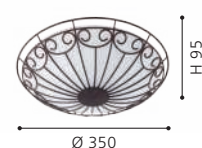





92143





97886



99348

Matching fabric luminaires  
can be found from page 114.

Passende Stoffleuchten finden  
Sie ab Seite 114.

Vous trouverez les luminaires à textile  
assorties à partir de la page 114.

### 97886 SAN PERI

wall light; steel, black  
Wandleuchte; Stahl, schwarz  
applique; acier, noir

L 130, B 300, H 210



E27 1x 10W



9 002759 978860



### 99348 STAITI 1

wall light; steel, black / fabric, black  
Wandleuchte; Stahl, schwarz / Textil, schwarz  
applique; acier, noir / tissu, noir

L 160, H 240, A 500



E27 1x 40W



9 002759 993481







99348



96567

LED



## TAZZOLI

These luminaires have a USB-connection.

Diese Leuchten verfügen über einen USB-Anschluss.

Ces luminaires disposent d'une connexion USB.



### 96567 TAZZOLI

wall light; steel, plastic, satin nickel, black  
Wandleuchte; Stahl, Kunststoff, nickel-matt, schwarz  
applique; acier, plastique, nickel mat, noir

L 65, H 300, A 160



3,8W 320lm



9 002759 965679



### 96566 TAZZOLI

wall light; steel, plastic, white  
Wandleuchte; Stahl, Kunststoff, weiss  
applique; acier, plastique, blanc

L 65, H 300, A 160



3,8W 320lm



9 002759 965662



### 98263 CIGLIE

wall light; aluminium, steel, black  
Wandleuchte; Alu, Stahl, schwarz  
applique; aluminium, acier, noir

L 180, H 180, A 210

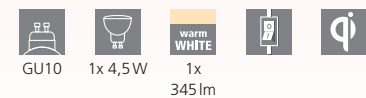

1x 4,5W 1x 345lm



9 002759 982638



INCL.

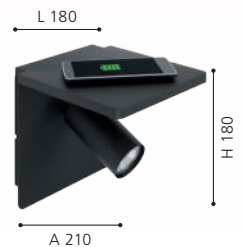





99595

LED



### CARTIGNANO

This sleek, modern luminaire is multifunctional, providing illumination and a handy coat rack feature. It can be mounted directly on a wall outlet, and a cord with switch is included in your deliver.

Diese schlichte, moderne Leuchte dient nicht nur als Lichtquelle, sondern auch als Garderobe. Sie kann direkt im Wandauslass montiert werden, ein Kabel mit Schalter wird automatisch mitgeliefert.

Ce luminaire sobre et moderne peuvent non seulement servir de source de lumière, mais aussi de porte-manteau. Les deux lampes peuvent être directement montées sur une prise murale. Le câble avec interrupteur est inclus dans la livraison.

### 99595 CARTIGNANO

wall light; steel, black / plastic, white  
Wandleuchte; Stahl, schwarz / Kunststoff, weiss  
applique; acier, noir / plastique, blanc

L 780, H 180, A 35

LED

7,8W

warm  
WHITE

900lm



9 002759 995959







99596



## 99596 CIVITATE

wall light; steel, wood, black, brown  
Wandleuchte; Stahl, Holz, schwarz, braun  
applique; acier, bois, noir, marron

L 760, B 100, H 85



18W



1900lm



9 002759 995966



## CIVITATE

The CIVITATE LED wall luminaire features a rectangular, black metal body with rounded corners. Five brown, rubber-wood brackets provide space and support for coats and jackets, making this the ideal illuminated coat rack. The CIVITATE emits a warm, comfortable light, providing indirect illumination in your entrance area or foyer. The minimalist design complements a modern interior, and can easily be turned on and off with a switch on the cord.

Die LED Wandleuchte CIVITATE besteht aus einem rechteckigen, schwarzen Metall-Körper mit abgerundeten Ecken. Dank der fünf Halterungen aus braunem Gummibaumholz bietet die Wandlampe genügend Platz für Jacken sowie Mäntel und kann so optimal als beleuchtete Garderobe genutzt werden. Die Leuchte spendet angenehmes warmweißes Licht und schafft so eine indirekte Beleuchtung im Eingangsbereich. Die minimalistische Leuchte rundet moderne Einrichtungsstile ab und ist bequem über einen Schalter am Kabel ein- und ausschaltbar.

L'applique murale LED CIVITATE est composée d'un boîtier rectangulaire en métal noir avec des angles arrondis. Les cinq supports en bois d'hévéa brun permettent d'accrocher des vestes et des manteaux, ce qui permet à l'applique de servir également de porte-manteau. L'applique diffuse une lumière blanc chaud agréable, et ainsi un éclairage indirect pour les entrées. Minimaliste, elle complète des styles intérieurs modernes et peut être facilement actionnée grâce à l'interrupteur situé sur le câble.

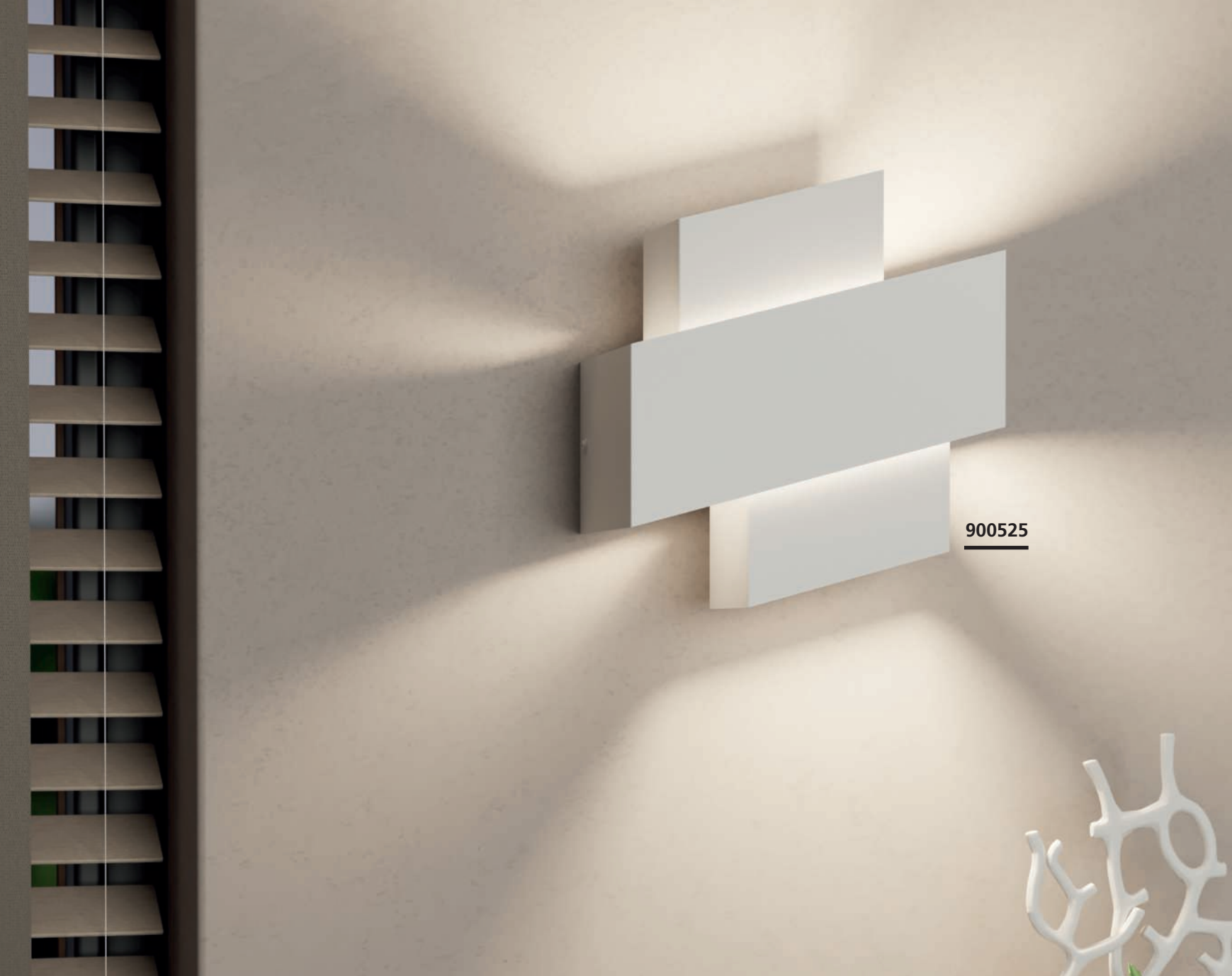

**900525**

**900525 TIMPAROSSA**

wall light; steel, white  
 Wandleuchte; Stahl, weiss  
 applique; acier, blanc

L 255, H 220, A 105



E27



1x 40W

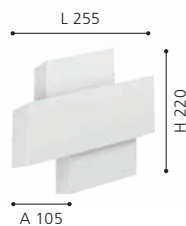

**900526 TIMPAROSSA**

wall light; steel, gold-coloured  
 Wandleuchte; Stahl, goldfarben  
 applique; acier, or

L 255, H 220, A 105



E27



1x 40W

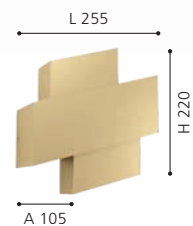

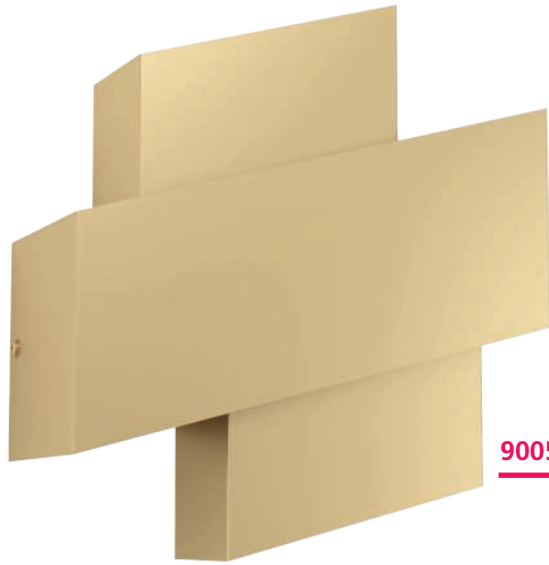

**900526**

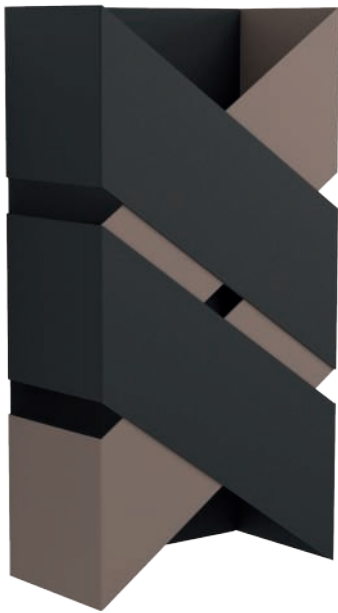

**99689**

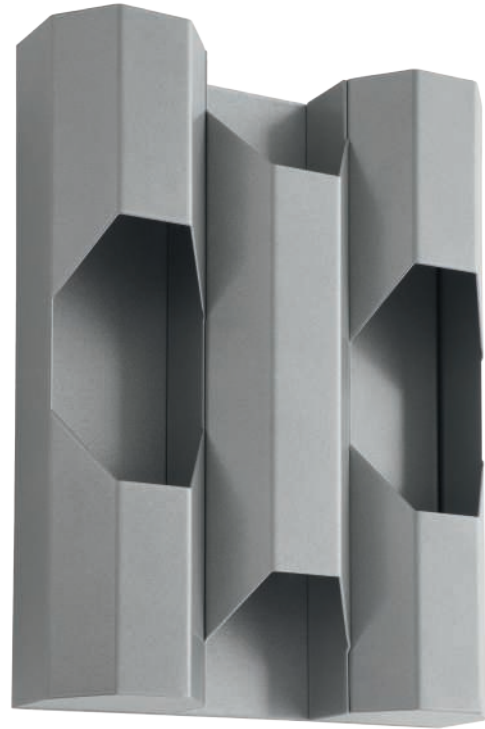

**98841**



**99689 GURARE**

wall light; steel, black, mocha-coloured  
Wandleuchte; Stahl, schwarz, mokkafarben  
applique; acier, noir, café

L 125, H 240, A 85

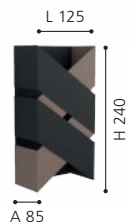
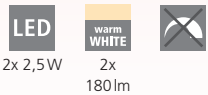

**98841 ZINACUA**

wall light; steel, silver  
Wandleuchte; Stahl, silber  
applique; acier, argent

L 225, H 310, A 85

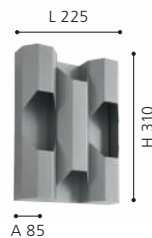
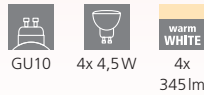



99087

LED

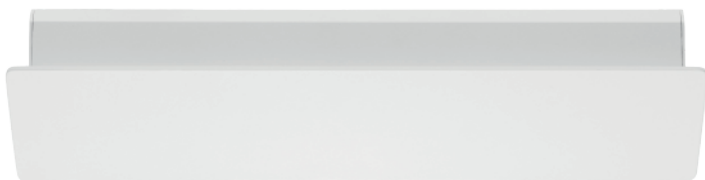

99086

LED



990325

LED

### 99087 ZUBIALDE

wall light; aluminium, steel, black, white  
Wandleuchte; Alu, Stahl, schwarz, weiss  
applique; aluminium, acier, noir, blanc

### 99086 ZUBIALDE

wall light; aluminium, steel, white  
Wandleuchte; Alu, Stahl, weiss  
applique; aluminium, acier, blanc

#### ZUBIALDE

The front plate of the luminaire can be swiveled. The light can be adjusted individually.

Die Frontplatte der Leuchte ist schwenkbar. Somit kann das Lichtbild individuell eingestellt werden.

La plaque frontale du luminaire peut être pivotée. La lumière peut être réglée individuellement.

L 360, H 80, A 50

LED

12W

warm WHITE

1550lm



9 002759 990879



L 360, H 80, A 50

LED

12W

warm WHITE

1550lm



9 002759 990862

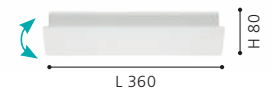





96049



96048



### 900325 ZUBIALDE

wall light; steel, wood, black, brown  
Wandleuchte; Stahl, Holz, schwarz, braun  
applique; acier, bois, noir, marron

L 360, H 80, A 50



12W

### 96049 ONO 2

wall light; aluminium, anthracite / plastic, clear  
Wandleuchte; Alu, anthrazit / Kunststoff, klar  
applique; aluminium, gris anthracite / plastique, transparent

L 90, H 80, A 130



2x 2,5W 500lm

### 96048 ONO 2

wall light; aluminium, white / plastic, clear  
Wandleuchte; Alu, weiss / Kunststoff, klar  
applique; aluminium, blanc / plastique, transparent

L 90, H 80, A 130



2x 2,5W 500lm



9 008606 235360



9 002759 960490



9 002759 960483





98542



98541



98543



### 98541 MACCARI

wall light; aluminium, steel, white / plastic, transparent  
Wandleuchte; Alu, Stahl, weiss / Kunststoff, transparent  
applique; aluminium, acier, blanc / plastique, transparent

L 270, H 75, A 130



### 98542 MACCARI

wall light; aluminium, steel, black, gold / plastic, transparent  
Wandleuchte; Alu, Stahl, schwarz, gold / Kunststoff, transparent  
applique; aluminium, acier, noir, or / plastique, transparent

L 270, H 75, A 130

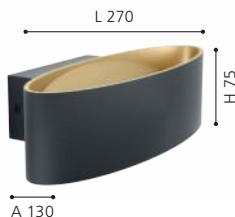

### 98543 MACCARI

wall light; aluminium, steel, white, satin nickel / plastic, transparent  
Wandleuchte; Alu, Stahl, weiss, nickel-matt / Kunststoff, transparent  
applique; aluminium, acier, blanc, nickel mat / plastique, transparent

L 270, H 75, A 130

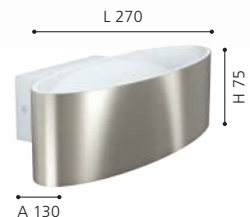



98544

LED



98545

LED

### 98544 FELONICHE

wall light; aluminium, white / plastic, transparent  
 Wandleuchte; Alu, weiss / Kunststoff, transparent  
 applique; aluminium, blanc / plastique, transparent

L 220, H 100, A 75



10W 1300lm



9 002759 985448

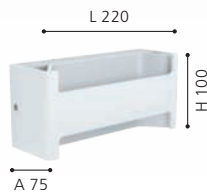

### 98545 FELONICHE

wall light; aluminium, black, gold / plastic, transparent  
 Wandleuchte; Alu, schwarz, gold / Kunststoff, transparent  
 applique; aluminium, noir, or / plastique, transparent

L 220, H 100, A 75



10W 1300lm



9 002759 985455

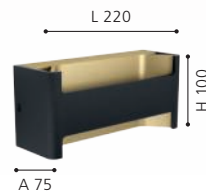



98421



98422



98423



**98421 SANIA 4**

wall light; aluminium, white  
Wandleuchte; Alu, weiss  
applique; aluminium, blanc

L 130, H 80, A 90

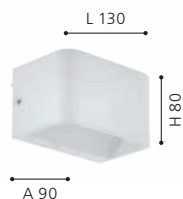

**98422 SANIA 4**

wall light; aluminium, white  
Wandleuchte; Alu, weiss  
applique; aluminium, blanc

L 200, H 80, A 90

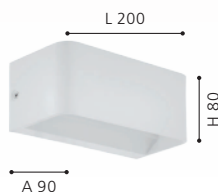

**98423 SANIA 4**

wall light; aluminium, white  
Wandleuchte; Alu, weiss  
applique; aluminium, blanc

L 365, H 80, A 90

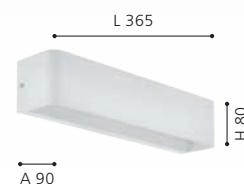





98424



98425



98426



### 98424 SANIA 4

wall light; aluminium, satin nickel  
Wandleuchte; Alu, nickel-matt  
applique; aluminium, nickel mat

L 130, H 80, A 90



6W 670lm



9 002759 984243

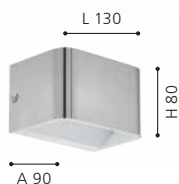

### 98425 SANIA 4

wall light; aluminium, satin nickel  
Wandleuchte; Alu, nickel-matt  
applique; aluminium, nickel mat

L 200, H 80, A 90



10W 1300lm



9 002759 984250

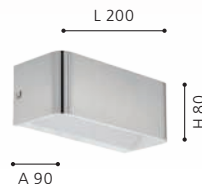

### 98426 SANIA 4

wall light; aluminium, satin nickel  
Wandleuchte; Alu, nickel-matt  
applique; aluminium, nickel mat

L 365, H 80, A 90



12W 1400lm



9 002759 984267

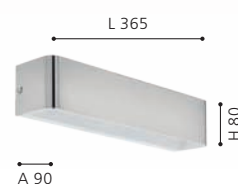



96261

LED



### 96261 PASSA

wall light; steel, satin nickel, chrome  
Wandleuchte; Stahl, nickel-matt, chrom  
applique; acier, nickel mat, chrome

L 60, H 170, A 85



GU10



2x 3W



warm  
WHITE

2x

250lm



INCL.





96264

LED



95368

LED



95377

LED

### 96264 PASSA

wall light; steel, satin nickel, chrome  
Wandleuchte; Stahl, nickel-matt, chrom  
applique; acier, nickel mat, chrome

L 55, H 170, A 85



GU10



2x 3W



2x  
warm  
WHITE  
250lm



9 002759 962647



### 95368 PASSA

wall light; steel, chrome, white  
Wandleuchte; Stahl, chrom, weiss  
applique; acier, chrome, blanc

L 60, H 170, A 85



GU10



2x 3W



2x  
warm  
WHITE  
250lm



9 002759 953683



### 95377 PASSA

wall light; steel, chrome, white  
Wandleuchte; Stahl, chrom, weiss  
applique; acier, chrome, blanc

L 55, H 170, A 85



GU10



2x 3W



2x  
warm  
WHITE  
250lm



9 002759 953775





95371

LED



95379

LED

### 95371 PASSA

wall light; steel, brown, copper  
Wandleuchte; Stahl, braun, kupfer  
applique; acier, marron, cuivre

L 60, H 170, A 85

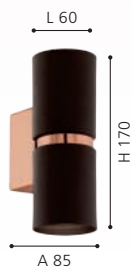
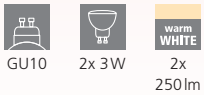

### 95379 PASSA

wall light; steel, brown, copper  
Wandleuchte; Stahl, braun, kupfer  
applique; acier, marron, cuivre

L 55, H 170, A 85

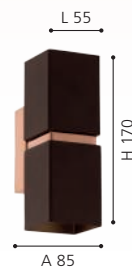
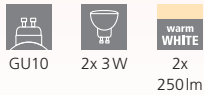

### 95364 PASSA

wall light; steel, black, gold  
Wandleuchte; Stahl, schwarz, gold  
applique; acier, noir, or

L 60, H 170, A 85

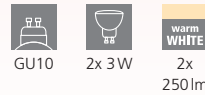





95364

LED



95373

LED

### 95373 PASSA

wall light; steel, black, gold  
Wandleuchte; Stahl, schwarz, gold  
applique; acier, noir, or

L 55, H 170, A 85



GU10



2x 3W



warm  
WHITE  
2x  
250lm



9 002759 953737



INCL.

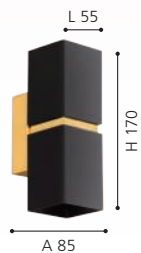



**98379**



**98755**



**98759**

### 98379 GASCUERIA

wall light; plastic, steel, gold, black  
Wandleuchte; Kunststoff, Stahl, gold, schwarz  
applique; plastique, acier, or, noir

L 290, H 330, A 130



E27

1x 60W

L 290



H 330

A 130



9 002759 983796

### 98755 ELIZONDO

wall light; steel, black, gold  
Wandleuchte; Stahl, schwarz, gold  
applique; acier, noir, or

L 80, H 270, A 115



E14

1x 40W

L 80



H 270

A 115



9 002759 987558

### 98759 FALICETTO

wall light; steel, black, gold  
Wandleuchte; Stahl, schwarz, gold  
applique; acier, noir, or

L 160, H 250, A 115



E27

1x 40W

L 160



H 250

A 115



9 002759 987596



**900375**

**900375 HAYES**

wall light; steel, black, gold  
Wandleuchte; Stahl, schwarz, gold  
applique; acier, noir, or

L 120, H 225, A 120



E27



1x 40W



9 008606 240555



**HAYES**

The golden element of the luminaire can be rotated. This allows the light to be individually adjusted.

Das goldene Element der Leuchte ist drehbar. Dadurch lässt sich der Lichtschein individuell anpassen.

L'élément doré du luminaire peut être tourné. Cela permet de régler la lumière individuellement.





**900343**



**900518**

### 900343 TANURA

wall light; steel, black  
Wandleuchte; Stahl, schwarz  
applique; acier, noir

L 245, H 110, A 105



E27



1x 25W



9 008606 243495

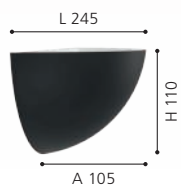

### 900518 GUANAL

wall light; aluminium, steel, chrome  
Wandleuchte; Alu, Stahl, chrom  
applique; aluminium, acier, chrome

L 600, B 50, H 60



E27



4x 40W



9 008606 244478

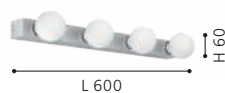

### 900517 GUANAL

wall light; aluminium, steel, black  
Wandleuchte; Alu, Stahl, schwarz  
applique; aluminium, acier, noir

L 600, B 50, H 60



E27



4x 40W



9 008606 244461







900517



98656



98657



**98656 MONGODIO 1**

wall / ceiling light; steel, white / plastic, white  
 Wand- / Deckenleuchte; Stahl, weiss / Kunststoff, weiss  
 applique / plafonnier; acier, blanc / plastique, blanc

H 35, Ø 200



8,6W 950lm



9 002759 986568



**98657 MONGODIO 1**

wall / ceiling light; steel, white / plastic, white  
 Wand- / Deckenleuchte; Stahl, weiss / Kunststoff, weiss  
 applique / plafonnier; acier, blanc / plastique, blanc

H 35, Ø 250



11,4W 1300lm



9 002759 986575





98676

LED

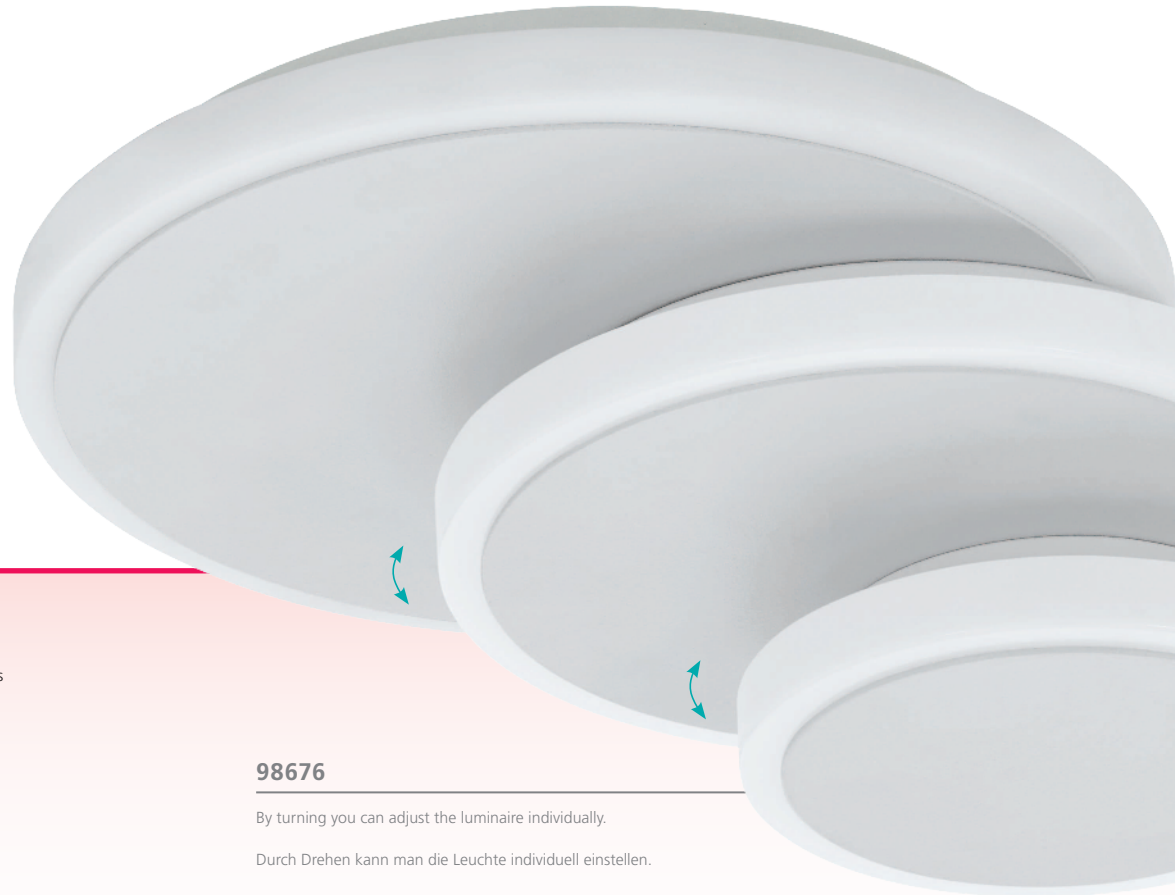

### 98676 ELGVERO

wall / ceiling light; steel, white / plastic, white  
 Wand- / Deckenleuchte; Stahl, weiss / Kunststoff, weiss  
 applique / plafonnier; acier, blanc / plastique, blanc

H 100, Ø 250

LED	warm WHITE	LED	warm WHITE	LED
6,5W	750lm	8,6W	950lm	13W

warm WHITE		
1500lm		



### 98676

By turning you can adjust the luminaire individually.

Durch Drehen kann man die Leuchte individuell einstellen.

En tournant, vous pouvez régler la lampe individuellement.



30658

LED



30659

LED



33941

LED

### 30658 CADEGAL

ceiling light; steel, black / plastic, white  
Deckenleuchte; Stahl, schwarz / Kunststoff, weiss  
plafonnier; acier, noir / plastique, blanc

L 200, B 200, H 50

LED

neutral  
WHITE



7,8W

1200lm

### 30659 CADEGAL

ceiling light; steel, black / plastic, white  
Deckenleuchte; Stahl, schwarz / Kunststoff, weiss  
plafonnier; acier, noir / plastique, blanc

H 50, Ø 200

LED

neutral  
WHITE



7,8W

1100lm

### 33941 CADEGAL

ceiling light; steel, white / plastic, white  
Deckenleuchte; Stahl, weiss / Kunststoff, weiss  
plafonnier; acier, blanc / plastique, blanc

L 200, B 200, H 50

LED

neutral  
WHITE



7,8W

1200lm



9 002759 306588

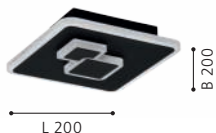

9 002759 306595

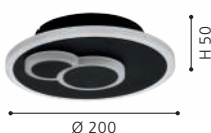

9 002759 339418

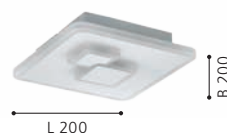



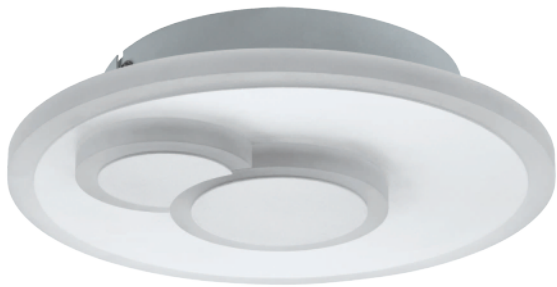

33942

LED



33964

LED

### 33942 CADEGAL

ceiling light; steel, white / plastic, white  
Deckenleuchte; Stahl, weiss / Kunststoff, weiss  
plafonnier; acier, blanc / plastique, blanc

H 50, Ø 200



7,8W 1100lm

### 33964 REMIDOS

ceiling light; steel, white / plastic, white  
Deckenleuchte; Stahl, weiss / Kunststoff, weiss  
plafonnier; acier, blanc / plastique, blanc

H 90, Ø 400



18,5W 2600lm





98888



96037



96038



### 98888 METRASS

wall light; aluminium, black / plastic, satined  
Wandleuchte; Alu, schwarz / Kunststoff, satiniert  
applique; aluminium, noir / plastique, satiné

L 200, H 105, A 60



1x 5,6W 680lm

### 96037 METRASS

wall light; aluminium, white / plastic, satined  
Wandleuchte; Alu, weiss / Kunststoff, satiniert  
applique; aluminium, blanc / plastique, satiné

L 200, H 105, A 60



1x 5,6W 680lm

### 96038 METRASS

wall light; aluminium, satin nickel / plastic, satined  
Wandleuchte; Alu, nickel-matt / Kunststoff, satiniert  
applique; aluminium, nickel mat / plastique, satiné

L 200, H 105, A 60



1x 5,6W 680lm



9 002759 988883

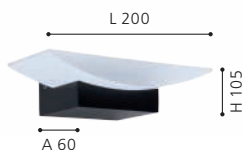

9 002759 960377

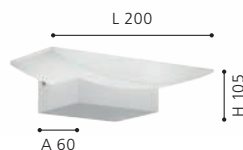

9 002759 960384

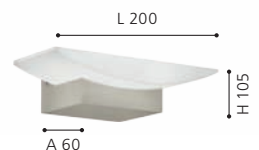



96042



96043



### 96042 METRASS 2

wall / ceiling light; aluminium, white / plastic, satined  
Wand- / Deckenleuchte; Alu, weiss / Kunststoff, satiniert  
applique / plafonnier; aluminium, blanc / plastique, satiné

L 170, H 200, A 55



2x 4,5W 960lm



9 002759 960421

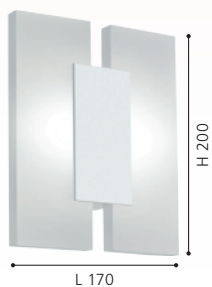

### 96043 METRASS 2

wall / ceiling light; aluminium, satin nickel / plastic, satined  
Wand- / Deckenleuchte; Alu, nickel-matt / Kunststoff, satiniert  
applique / plafonnier; aluminium, nickel mat / plastique, satiné

L 170, H 200, A 55



2x 4,5W 960lm



9 002759 960438





96039

LED





96041



### 96039 METRASS 1

wall light; aluminium, white / plastic, satined  
Wandleuchte; Alu, weiss / Kunststoff, satiniert  
applique; aluminium, blanc / plastique, satiné

L 130, H 130, A 50



1x 4,5W 480lm



9 002759 960391



### 96041 METRASS 1

wall light; aluminium, satin nickel / plastic, satined  
Wandleuchte; Alu, nickel-matt / Kunststoff, satiniert  
applique; aluminium, nickel mat / plastique, satiné

L 130, H 130, A 50



1x 4,5W 480lm



9 002759 960414





99606

LED



99607

LED



99609

LED

**99606 SARGINTO**

wall / ceiling light; steel, white / plastic, white  
Wand- / Deckenleuchte; Stahl, weiss / Kunststoff, weiss  
applique / plafonnier; acier, blanc / plastique, blanc

L 590, B 140, H 45

LED 6,3W warm WHITE 950lm LED 5,4W warm WHITE 570lm



9 002759 996062

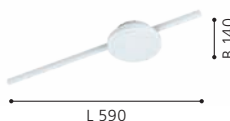

**99607 SARGINTO**

wall / ceiling light; steel, white / plastic, white  
Wand- / Deckenleuchte; Stahl, weiss / Kunststoff, weiss  
applique / plafonnier; acier, blanc / plastique, blanc

L 590, B 130, H 45

LED 6,3W warm WHITE 950lm LED 5,4W warm WHITE 570lm



9 002759 996079





99608

LED

### 99609 SARGINTO

wall / ceiling light; steel, black / plastic, white  
Wand- / Deckenleuchte; Stahl, schwarz / Kunststoff, weiss  
applique / plafonnier; acier, noir / plastique, blanc

L 590, B 130, H 45



### 99608 SARGINTO

wall / ceiling light; steel, black / plastic, white  
Wand- / Deckenleuchte; Stahl, schwarz / Kunststoff, weiss  
applique / plafonnier; acier, noir / plastique, blanc

L 590, B 140, H 45

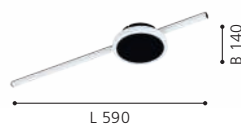

# BATH & MIRROR LUMINAIRES

BAD- & SPIEGELLEUCHTEN

LUMINAIRES DE BAIN & MIROIR

## PURE RELAXATION

Turn your bathroom into your personal wellness oasis. Trendy bathroom and mirror luminaires give a pleasant light and ensure relaxation and comfort.

## ENTSPANNUNG PUR

Verwandeln Sie Ihr Badezimmer in eine persönliche Wohlfühloase. Trendige Bad- und Spiegelleuchten spenden ein angenehmes Licht und sorgen für Entspannung und Ihr Wohlbefinden.



## DE LA PURE DÉTENTE

Transformez votre salle de bains en un îlot personnel de bien-être. Des éclairages à la mode de miroirs et de bain confèrent une lumière agréable et vous assurent de la détente et du bien-être.





# OVERVIEW

## BATH & MIRROR LUMINAIRES

 AMEZOLA p. 600	 SAN PERI 1 p. 601	 TAMARA 1 p. 602-603	 ALMONTE p. 604	 TOLORICO p. 606	 PALMITAL p. 608-609	 MOSIANO p. 609	 WASAO 1 p. 609
 BARI-M p. 610	 FRANIA p. 610, 612	 FRANIA-S p. 611	 MANILVA 1 p. 612	 PINETTO p. 614-615	 LED PALERMO p. 615	 LED CARPI p. 616-617	 FUEVA 5 p. 618-626
 ROMENDO 1 p. 628-629	 SIDERNO p. 630	 SANIA 5 p. 630-631	 GEMILIANA p. 632	 VERDELLO p. 632-633	 ALCUDIA p. 633	 CABUS p. 634-635	 CALNOVA p. 635
 TORRETTA p. 635	 TRAGACETE 1 p. 636-637	 GITA 2 p. 638	 TABIANO p. 641	 VADUMI p. 642	 PANDELLA 1 p. 644-647	 PANDELLA 2 p. 644, 648	 VINCHIO p. 648
 PALMERA p. 650	 ZOLA p. 650	 BARI 1 p. 651	 STICKER p. 651	 BUENAVISTA p. 652	 BUENAVISTA 1 p. 654	 BUENAVISTA 2 p. 654-655	
 TABIANO-Z p. 49	 JUAREZA-Z p. 49	 FUEVA-Z p. 68-79					

You can also find bathroom and mirror lights in EGLO connect.Z.  
 Bad und Spiegelleuchten finden sie auch in EGLO connect.Z.  
 Vous pouvez également trouver des lampes de salle de bain et de miroir dans EGLO connect.Z.



This product is available in different colors and shapes./ Dieser Artikel ist in unterschiedlichen Farben und Formen verfügbar.  
 Cet article est disponible en différentes couleurs et formes.

# COLOUR RENDERING INDEX

FARBWIEDERGABE-INDEX

L'INDICE DE RESTITUTION DE COULEURS

## QUALITY CRITERION COLOUR RENDERING

The colour rendering index Ra describes the colour rendering quality of lamps. The higher the Ra value, the less will the artificial light change the colour of an object. The maximum Ra value (e.g. the Ra value of the sun) is 100.

Therefore, lamps with an Ra above 90 will make you look better.

Lamps with an Ra value above 90 are marked with this button: 

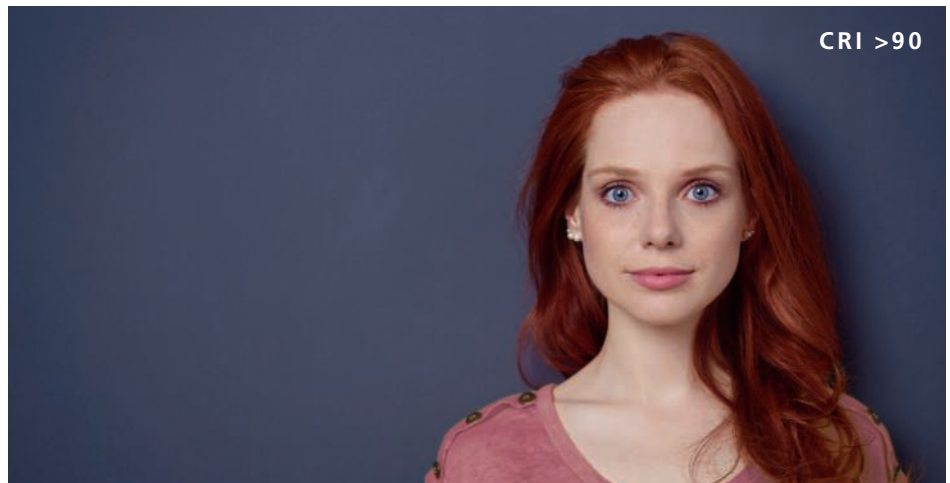

## QUALITÄTSKRITERIUM FARBWIEDERGABE

Mit dem Farbwiedergabe-Index Ra wird die Qualität der Farbwiedergabe von Leuchten beschrieben. Je höher der Ra-Wert ist, desto weniger verfälscht das künstliche Licht die Farbe von Objekten. Der maximale Ra-Wert (z.B. der Ra-Wert der Sonne) ist 100.

Leuchten mit Ra >90 lassen Sie somit besser aussehen.

Leuchten die einen Ra-Wert von >90 haben, sind mit diesem Button gekennzeichnet: 

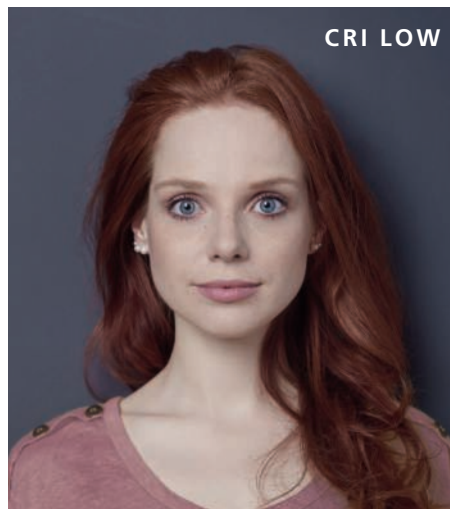

## CRITÈRE DE QUALITÉ INDIQUANT LA RESTITUTION DES COULEURS

L'indice de restitution de couleurs Ra décrit la qualité de restitution des éclairages. Plus la valeur Ra est élevée, moins la lumière artificielle falsifie la couleur des objets. La valeur Ra maximale (par ex. la valeur Ra du soleil) est 100.

Ainsi, favorisez des lampes avec une valeur Ra > 90.

Les lampes ayant une valeur Ra > 90 sont identifiées par ce bouton: 



AMEZOLA



99124



99123



99122

### 99123 AMEZOLA

wall light; steel, black / glass, clear  
Wandleuchte; Stahl, schwarz / Glas, klar  
applique; acier, noir / verre, transparent

L 110, H 260, A 100



E27

1x 60W

IP44



9 002759 991234



A 100

### 99124 AMEZOLA

wall light; steel, black / glass, clear  
Wandleuchte; Stahl, schwarz / Glas, klar  
applique; acier, noir / verre, transparent

L 110, H 380, A 100



E27

2x 60W

IP44



9 002759 991241



A 100

### 99122 AMEZOLA

wall / ceiling light; steel, black / glass, clear  
Wand- / Deckenleuchte; Stahl, schwarz / Glas, klar  
applique / plafonnier; acier, noir / verre, transparent

L 290, H 290, A 130



E27

2x 40W

IP44



9 002759 991227



L 290





900428

LED

### 900428 SAN PERI 1

wall light; steel, black, white  
Wandleuchte; Stahl, schwarz, weiss  
applique; acier, noir, blanc

L 130, H 180, A 160



GU10



1x 3W



1x  
warm  
WHITE



IP44



9 008606 243877



INCL.





95994

LED



95993

LED



95995

LED

### 95993 TAMARA 1

spot; steel, glass, white, chrome  
Spot; Stahl, Glas, weiss, chrom  
spot; acier, verre, blanc, chrome

L 120, B 120



### 95994 TAMARA 1

spot; steel, glass, white, chrome  
Spot; Stahl, Glas, weiss, chrom  
spot; acier, verre, blanc, chrome

L 460, B 70

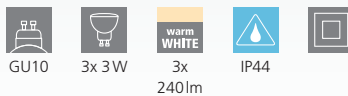

### 95995 TAMARA 1

spot; steel, glass, white, chrome  
Spot; Stahl, Glas, weiss, chrom  
spot; acier, verre, blanc, chrome

L 240, B 260

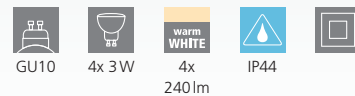

9 002759 959937



L 120



9 002759 959944



L 460



9 002759 959951



L 240



33677

LED



33678

LED

### 33677 TAMARA 1

spot; steel, black, chrome / glass, clear  
 Spot; Stahl, schwarz, chrom / Glas, klar  
 spot; acier, noir, chrome / verre, transparent

L 120, B 120

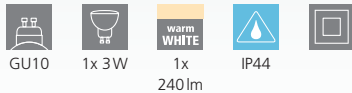

GU10 1x 3W 1x warm WHITE IP44 240lm



9 002759 336776



### 33678 TAMARA 1

spot; steel, black, chrome / glass, clear  
 Spot; Stahl, schwarz, chrom / Glas, klar  
 spot; acier, noir, chrome / verre, transparent

L 240, B 260

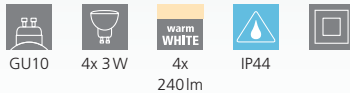

GU10 4x 3W 4x warm WHITE IP44 240lm



9 002759 336783

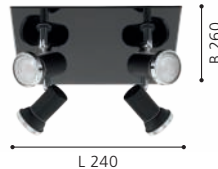

DESIGN  
HIGHLIGHT  
DETAIL



94879

LED



97699

LED

### 94879 ALMONTE

wall light; steel, chrome / brilliant glass, clear  
Wandleuchte; Stahl, chrom / Brillantglas, klar  
Applique; acier, chrome / verre brillant, transparent

L 110, H 230, A 170



9 002759 948795



### 97699 ALMONTE

ceiling light; steel, chrome / brilliant glass, clear  
Deckenleuchte; Stahl, chrom / Brillantglas, klar  
plafonnier; acier, chrome / verre brillant, transparent

H 300, Ø 500



9 002759 976996



### 94878 ALMONTE

ceiling light; steel, chrome / brilliant glass, clear  
Deckenleuchte; Stahl, chrom / Brillantglas, klar  
plafonnier; acier, chrome / verre brillant, transparent

H 230, Ø 350



9 002759 948788







94878

LED







## TOLORICO

These luminaires come with high quality brilliant glass.

Diese Leuchten sind mit hochwertigem Brillantglas ausgestattet.

Ces lumières sont fabriquées avec une haute qualité  
Equipé de verre brillant.



97054

LED



97055

LED

### 97054 TOLORICO

wall / ceiling light; stainless steel, chrome / plastic, brilliant glass, clear

Wand- / Deckenleuchte; Edelstahl, chrom / Kunststoff, Brillantglas, klar

Applique/Plafonnier; acier inoxydable, chrome / plastique, verre brillant, transparent  
L 350, B 100, H 70



8W



1000lm



IP44



### 97055 TOLORICO

wall / ceiling light; stainless steel, chrome / plastic, brilliant glass, clear

Wand- / Deckenleuchte; Edelstahl, chrom / Kunststoff, Brillantglas, klar

Applique/Plafonnier; acier inoxydable, chrome / plastique, verre brillant, transparent  
L 570, B 100, H 75



20,5W



2700lm



IP44



### 97056 TOLORICO

wall / ceiling light; stainless steel, chrome / plastic, brilliant glass, clear

Wand- / Deckenleuchte; Edelstahl, chrom / Kunststoff, Brillantglas, klar

Applique/Plafonnier; acier inoxydable, chrome / plastique, verre brillant, transparent  
L 350, B 350, H 75



22W



3000lm



IP44



9 002759 970543



9 002759 970550



9 002759 970567





97056

LED



97965

LED

### 97965 PALMITAL

wall / ceiling light; aluminium, steel, chrome / plastic, clear  
Wand- / Deckenleuchte; Alu, Stahl, chrom / Kunststoff, klar  
applique / plafonnier; aluminium, acier, chrome / plastique,  
transparent

L 880, B 100, H 90

LED

2x 11 W

warm  
WHITE

2700 lm



IP44



9 002759 979652

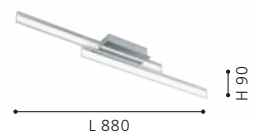





97966

LED



94626

LED



94884

LED

### 97966 PALMITAL

wall light; aluminium, steel, chrome / plastic, clear  
Wandleuchte; Alu, Stahl, chrom / Kunststoff, klar  
applique; aluminium, acier, chrome / plastique, transparent

L 595, H 80, A 65



1x 11 W 1350 lm

### 94626 MOSIANO

wall / ceiling light; stainless steel, chrome / glass opal-matt, white  
Wand- / Deckenleuchte; Edelstahl, chrom / Glas opal-matt, weiss  
applique / plafonnier; acier inoxydable, chrome / verre opale mat, blanc

H 115, Ø 110



1x 3,3 W 340 lm

### 94884 WASAO 1

wall / ceiling light; stainless steel, chrome / glass painted, white  
Wand- / Deckenleuchte; Edelstahl, chrom / Glas lackiert, weiss  
applique / plafonnier; acier inoxydable, chrome / verre laqué, blanc

L 320, B 320, H 60



4x 5,4 W 2040 lm



9 002759 979669



9 002759 946265



9 002759 948849

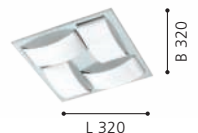



97531



97531



97884

LED

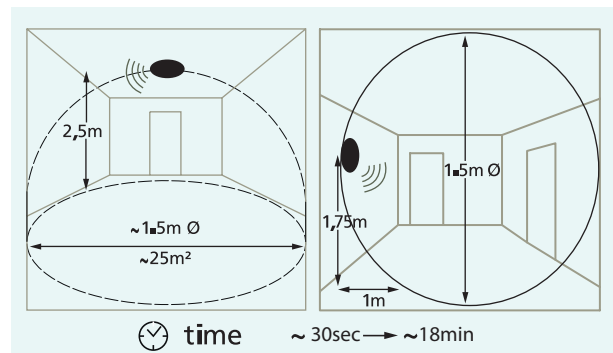

97531

This luminaire comes with an integrated motion sensor.  
The sensor is mounted invisibly behind the glass.

Diese Leuchte ist mit einem integrierten Bewegungssensor ausgestattet.  
Der Sensor ist unsichtbar hinter dem Glas befestigt.

Ce luminaire vient avec un capteur de mouvement intégré.  
Le capteur est attaché invisiblement derrière le verre.

### 97531 BARI-M

ceiling light; plastic, white / glass, white  
Deckenleuchte; Kunststoff, weiss / Glas, weiss  
plafonnier; plastique, blanc / verre, blanc

H 110, Ø 275



E27



1x 20W



IP44



### 97884 FRANIA

wall / ceiling light; steel, white / plastic, white  
Wand- / Deckenleuchte; Stahl, weiss / Kunststoff, weiss  
applique / plafonnier; acier, blanc / plastique, blanc

H 70, Ø 330



14,6 W



1600 lm



IP44



9 002759 975319



Ø 275



9 002759 978846



Ø 330



900619



900364



900363



### 900619 FRANIA-S

wall / ceiling light; steel, white / plastic with crystal effect, white  
Wand- / Deckenleuchte; Stahl, weiss / Kunststoff m.Kristalleffekt, weiss  
applique / plafonnier; acier, blanc / plastique avec effet cristal, blanc

H 55, Ø 310



18W 1850lm

### 900363 FRANIA-S

wall / ceiling light; steel, white / plastic with crystal effect, white  
Wand- / Deckenleuchte; Stahl, weiss / Kunststoff m.Kristalleffekt, weiss  
applique / plafonnier; acier, blanc / plastique avec effet cristal, blanc

H 55, Ø 310



18W 1850lm

### 900364 FRANIA-S

wall / ceiling light; steel, white / plastic with crystal effect, white  
Wand- / Deckenleuchte; Stahl, weiss / Kunststoff m.Kristalleffekt, weiss  
applique / plafonnier; acier, blanc / plastique avec effet cristal, blanc

L 330, B 330, H 70



14,6W 1600lm



9 008606 245161



9 008606 234455

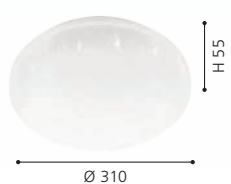

9 008606 234462





97885

LED



96231

LED

### 97885 FRANIA

wall / ceiling light; steel, white / plastic, white  
Wand- / Deckenleuchte; Stahl, weiss / Kunststoff, weiss  
applique / plafonnier; acier, blanc / plastique, blanc

L 330, B 330, H 70



14,6W 1600lm

### 96231 MANILVA 1

wall light; steel, satin nickel / plastic, white  
Wandleuchte; Stahl, nickel-matt / Kunststoff, weiss  
applique; acier, nickel mat / plastique, blanc

L 290, B 290, H 70



4x 3,6W 1480lm

### 96229 MANILVA 1

wall light; steel, chrome / plastic, white  
Wandleuchte; Stahl, chrom / Kunststoff, weiss  
applique; acier, chrome / plastique, blanc

L 290, B 290, H 70



4x 3,6W 1480lm



9 002759 978853



9 002759 962319



9 002759 962296







96229

LED



900366

LED



### 900366 PINETTO

wall / ceiling light; steel, white / plastic, white, black  
Wand- / Deckenleuchte; Stahl, weiss / Kunststoff, weiss, schwarz  
applique / plafonnier; acier, blanc / plastique, blanc, noir

H 65, Ø 340

LED

18W

neutral  
WHITE

1850lm



IP44



9 008606 235971





900365

LED



94998

LED



94999

LED

### 900365 PINETTO

wall / ceiling light; steel, white / plastic, white, chrome  
Wand- / Deckenleuchte; Stahl, weiss / Kunststoff, weiss, chrom  
applique / plafonnier; acier, blanc / plastique, blanc, chrome

H 65, Ø 340



18W 1850lm

### 94998 LED PALERMO

wall / ceiling light; steel, chrome / satin glass, white painted  
Wand- / Deckenleuchte; Stahl, chrom / Glas satiniert, weiss  
lackiert  
applique / plafonnier; acier, chrome / verre satiné, blanc laqué

H 60, Ø 225



3x 3,6W 1110lm

### 94999 LED PALERMO

wall / ceiling light; steel, chrome / satin glass, white painted  
Wand- / Deckenleuchte; Stahl, chrom / Glas satiniert, weiss  
lackiert  
applique / plafonnier; acier, chrome / verre satiné, blanc laqué

H 75, Ø 300



3x 5,7W 2100lm



9 008606 235964

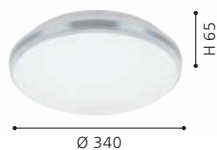

9 002759 949983



9 002759 949990







33682



94967



95282



### 33682 LED CARPI

wall / ceiling light; steel, black, white / plastic, white  
Wand- / Deckenleuchte; Stahl, schwarz, weiss / Kunststoff, weiss  
applique / plafonnier; acier, noir, blanc / plastique, blanc

Ø 300, A 75



3x 11 W  
3x  
950 lm

### 95282 LED CARPI

wall / ceiling light; steel, white, chrome / plastic, white  
Wand- / Deckenleuchte; Stahl, weiss, chrom / Kunststoff, weiss  
applique / plafonnier; acier, blanc, chrome / plastique, blanc

Ø 300, A 75



3x 3,6 W  
1110 lm

### 94967 LED CARPI

wall / ceiling light; steel, aluminium, white, brushed aluminium / plastic, white  
Wand- / Deckenleuchte; Stahl, Alu, weiss, alu-gebürstet / Kunststoff, weiss  
applique / plafonnier; acier, aluminium, blanc, aluminium brossé / plastique, blanc  
Ø 300, A 75



3x 3,6 W  
1110 lm



9 002759 336820



Ø 300



9 002759 952822



Ø 300



9 002759 949679



Ø 300





900369

LED



95283

LED



### 900369 LED CARPI

ceiling light; steel, brushed brass, white / plastic, white  
 Deckenleuchte; Stahl, messing-gebürstet, weiss / Kunststoff, weiss  
 plafonnier; acier, laiton brossé, blanc / plastique, blanc

Ø 300, A 75



3x 3,6W 1110lm

### 95283 LED CARPI

wall / ceiling light; steel, white, chrome / plastic, white  
 Wand- / Deckenleuchte; Stahl, weiss, chrom / Kunststoff, weiss  
 applique / plafonnier; acier, blanc, chrome / plastique, blanc

Ø 385, A 75



3x 7,3W 2220lm



9 008606 240623



Ø 300



9 002759 952839



Ø 385



## 99202, 99203, 99206, 99207

These luminaires are protected against splash water.

Diese Leuchten sind gegen Spritzwasser geschützt.

Les luminaires sont protégées contre les éclaboussures d'eau.



IP44

	0	1	2	3
EU	X	X	✓	✓
FR	X	X	X	✓



99202

LED

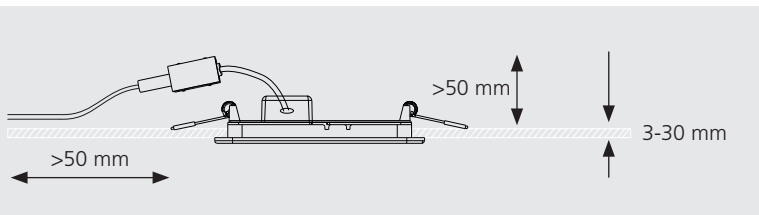

## 99202, 99203, 99206, 99207

Slim design and minimal installation depth. This makes it ideal for ceiling constructions with little space. Easy installation / replacement of the lights with practical connectors.

Schlanke Bauform und minimale Einbautiefe. Dadurch ideal für Deckenkonstruktionen mit wenig Platz. Einfache Montage / Austausch der Leuchten durch praktischen Verbinder.

Conception mince et profondeur d'installation minimale. Cela le rend idéal pour les constructions de plafond avec peu d'espace. Installation / remplacement facile des lumières avec des connecteurs pratiques.

### 99202 FUEVA 5

recessed light; steel, white / plastic, white  
Einbauleuchte; Stahl, weiss / Kunststoff, weiss  
luminaire encastrable; acier, blanc / plastique, blanc

Ø 86, ET 26



2,7W 330lm

Ø 75 IP44



9 002759 992026



Ø 86

### 99203 FUEVA 5

recessed light; steel, white / plastic, white  
Einbauleuchte; Stahl, weiss / Kunststoff, weiss  
luminaire encastrable; acier, blanc / plastique, blanc

Ø 166, ET 26



11W 1350lm

Ø 155 IP44



9 002759 992033



Ø 166

### 99206 FUEVA 5

recessed light; steel, white / plastic, white  
Einbauleuchte; Stahl, weiss / Kunststoff, weiss  
luminaire encastrable; acier, blanc / plastique, blanc

Ø 86, ET 26



2,7W 330lm

Ø 75 IP44



9 002759 992064



Ø 86



99203

LED



99206

LED

### 99207 FUEVA 5

recessed light; steel, white / plastic, white  
Einbauleuchte; Stahl, weiss / Kunststoff, weiss  
luminaire encastrable; acier, blanc / plastique, blanc

Ø 166, ET 26



11 W

1350 lm

Ø 155

IP44



9 002759 992071



Ø 166



99207

LED

99204, 99205, 99208, 99209

These luminaires are protected against splash water.

Diese Leuchten sind gegen Spritzwasser geschützt.

Les luminaires sont protégées contre les éclaboussures d'eau.



	0	1	2	3
EU	X	X	✓	✓
FR	X	X	X	✓



99208



99209



99204, 99205, 99208, 99209

Slim design and minimal installation depth. This makes it ideal for ceiling constructions with little space. Easy installation / replacement of the lights with practical connectors.

Schlanke Bauform und minimale Einbautiefe. Dadurch ideal für Deckenkonstruktionen mit wenig Platz. Einfache Montage / Austausch der Leuchten durch praktischen Verbinder.

Conception mince et profondeur d'installation minimale. Cela le rend idéal pour les constructions de plafond avec peu d'espace. Installation / remplacement facile des lumières avec des connecteurs pratiques.

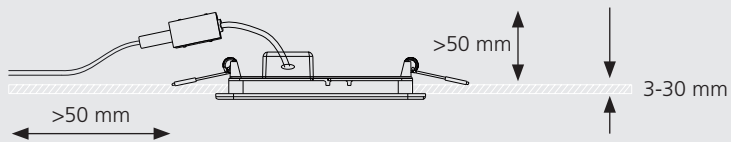

99208 FUEVA 5

recessed light; steel, chrome / plastic, white  
Einbauleuchte; Stahl, chrom / Kunststoff, weiss  
luminaire encastrable; acier, chrome / plastique, blanc

Ø 86, ET 26



99209 FUEVA 5

recessed light; steel, chrome / plastic, white  
Einbauleuchte; Stahl, chrom / Kunststoff, weiss  
luminaire encastrable; acier, chrome / plastique, blanc

Ø 166, ET 26



99205 FUEVA 5

recessed light; steel, chrome / plastic, white  
Einbauleuchte; Stahl, chrom / Kunststoff, weiss  
luminaire encastrable; acier, chrome / plastique, blanc

Ø 166, ET 26







99205

LED



99204

LED

### 99204 FUEVA 5

recessed light; steel, chrome / plastic, white  
Einbauleuchte; Stahl, chrom / Kunststoff, weiss  
luminaire encastrable; acier, chrome / plastique, blanc

Ø 86, ET 26

LED

2,7W

warm  
WHITE

330lm



Ø 75



IP44



9 002759 992040



RECESSED



Ø 86

99211, 99212, 99213, 99214

These luminaires are protected against splash water.

Diese Leuchten sind gegen Spritzwasser geschützt.

Les luminaires sont protégées contre les éclaboussures d'eau.



	0	1	2	3
EU	X	X	✓	✓
FR	X	X	X	✓



99213

LED



99214

LED

99211, 99212, 99213, 99214

Slim design and minimal installation depth. This makes it ideal for ceiling constructions with little space. Easy installation / replacement of the lights with practical connectors.

Schlanke Bauform und minimale Einbautiefe. Dadurch ideal für Deckenkonstruktionen mit wenig Platz. Einfache Montage / Austausch der Leuchten durch praktischen Verbinder.

Conception mince et profondeur d'installation minimale. Cela le rend idéal pour les constructions de plafond avec peu d'espace. Installation / remplacement facile des lumières avec des connecteurs pratiques.

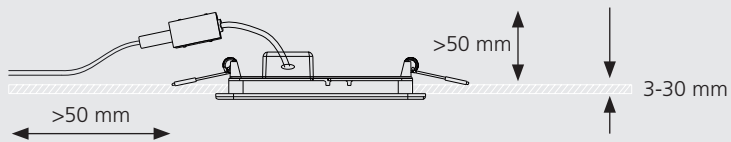

99213 FUEVA 5

recessed light; steel, black / plastic, white  
Einbauleuchte; Stahl, schwarz / Kunststoff, weiss  
luminaire encastrable; acier, noir / plastique, blanc

Ø 86, ET 26



Ø 86

99214 FUEVA 5

recessed light; steel, black / plastic, white  
Einbauleuchte; Stahl, schwarz / Kunststoff, weiss  
luminaire encastrable; acier, noir / plastique, blanc

Ø 166, ET 26



Ø 166

99212 FUEVA 5

recessed light; steel, black / plastic, white  
Einbauleuchte; Stahl, schwarz / Kunststoff, weiss  
luminaire encastrable; acier, noir / plastique, blanc

Ø 166, ET 26



Ø 166



99212

LED



99211

LED

### 99211 FUEVA 5

recessed light; steel, black / plastic, white  
Einbauleuchte; Stahl, schwarz / Kunststoff, weiss  
luminaire encastrable; acier, noir / plastique, blanc

Ø 86, ET 26

LED

2,7W

warm  
WHITE

330lm



Ø 75



IP44



9 002759 992118



RECESSED



Ø 86



99265



99267



### 99265 FUEVA 5

surface-mounted light; steel, white / plastic, white  
 Aufbauleuchte; Stahl, weiss / Kunststoff, weiss  
 luminaire en saillie; acier, blanc / plastique, blanc

H 28, Ø 285



20,5W 2400lm

### 99267 FUEVA 5

surface-mounted light; steel, black / plastic, white  
 Aufbauleuchte; Stahl, schwarz / Kunststoff, weiss  
 luminaire en saillie; acier, noir / plastique, blanc

H 28, Ø 285



20,5W 2400lm

### 99266 FUEVA 5

surface-mounted light; steel, chrome / plastic, white  
 Aufbauleuchte; Stahl, chrom / Kunststoff, weiss  
 luminaire en saillie; acier, chrome / plastique, blanc

H 28, Ø 285



20,5W 2400lm



9 002759 992651

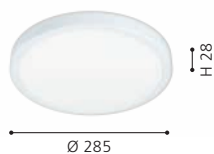

9 002759 992675

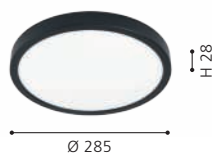

9 002759 992668







99266





99268



99271



### 99268 FUEVA 5

surface-mounted light; steel, white / plastic, white  
 Aufbauleuchte; Stahl, weiss / Kunststoff, weiss  
 luminaire en saillie; acier, blanc / plastique, blanc

L 285, B 285, H 30



### 99271 FUEVA 5

surface-mounted light; steel, black / plastic, white  
 Aufbauleuchte; Stahl, schwarz / Kunststoff, weiss  
 luminaire en saillie; acier, noir / plastique, blanc

L 285, B 285, H 30



### 99269 FUEVA 5

surface-mounted light; steel, chrome / plastic, white  
 Aufbauleuchte; Stahl, chrom / Kunststoff, weiss  
 luminaire en saillie; acier, chrome / plastique, blanc

L 285, B 285, H 30

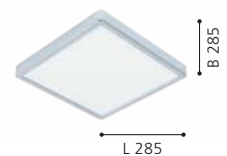
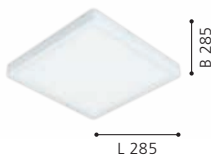



99269

LED





### 96541 ROMENDO 1

wall light; steel, chrome / plastic, clear, satiné  
Wandleuchte; Stahl, chrom / Kunststoff, klar, satiniert  
applique; acier, chrome / plastique, transparent, satiné

L 70, H 155, A 120

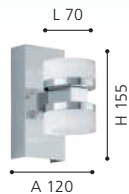
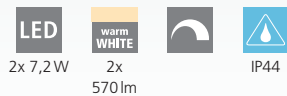

### 96542 ROMENDO 1

wall light; steel, chrome / plastic, clear, satiné  
Wandleuchte; Stahl, chrom / Kunststoff, klar, satiniert  
applique; acier, chrome / plastique, transparent, satiné

L 300, H 70, A 125

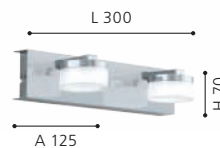
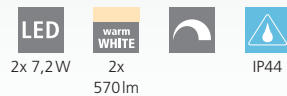

### 96544 ROMENDO 1

ceiling light; steel, chrome / plastic, clear, satiné  
Deckenleuchte; Stahl, chrom / Kunststoff, klar, satiniert  
plafonnier; acier, chrome / plastique, transparent, satiné

L 320, B 320, H 70

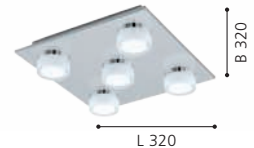
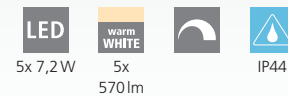





### ROMENDO 1

These luminaires are dimmable.

Diese Leuchten sind dimmbar.

Ces luminaires sont graduables.

### 96543 ROMENDO 1

wall light; steel, chrome / plastic, clear, satined  
Wandleuchte; Stahl, chrom / Kunststoff, klar, satiniert  
applique; acier, chrome / plastique, transparent, satiné

L 450, H 70, A 125

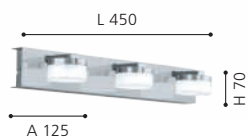
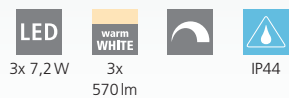

96543

LED

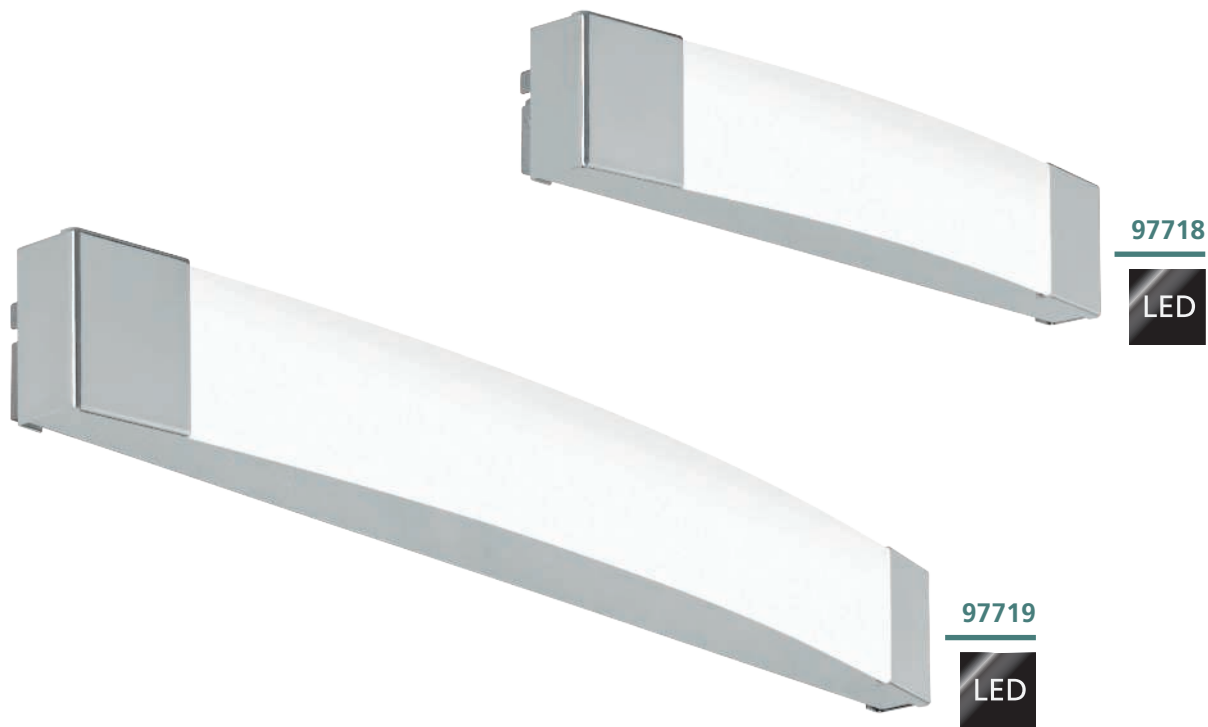

97718



97719

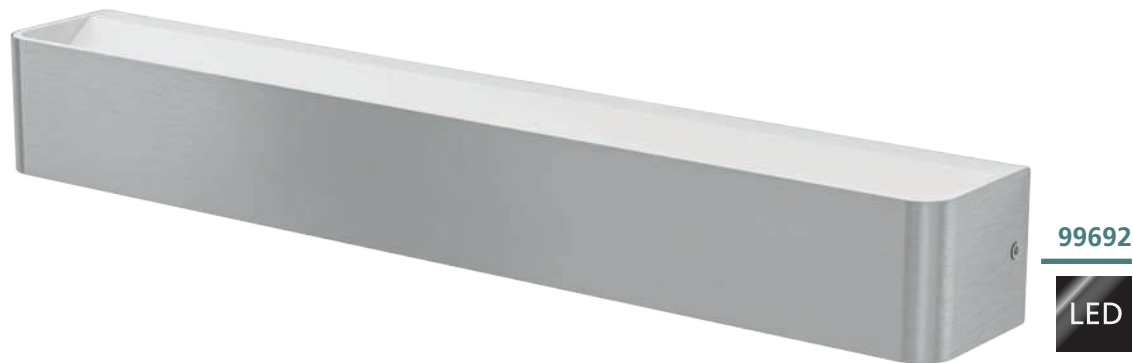

99692



### 97718 SIDERNO

mirror light; steel, chrome / plastic, satiné  
Spiegelleuchte; Stahl, chrom / Kunststoff, satiniert  
applique pour miroir; acier, chrome / plastique, satiné

L 350, B 60, A 55



8,3W



900lm



IP44



### 97719 SIDERNO

mirror light; steel, chrome / plastic, satiné  
Spiegelleuchte; Stahl, chrom / Kunststoff, satiniert  
applique pour miroir; acier, chrome / plastique, satiné

L 580, B 60, A 65



16W



1800lm



IP44



### 99692 SANIA 5

wall light; steel, satin nickel, white / plastic, satiné  
Wandleuchte; Stahl, nickel-matt, weiss / Kunststoff, satiniert  
applique; acier, nickel mat, blanc / plastique, satiné

L 620, H 80, A 90



26,5W



3200lm



IP44



9 002759 977184

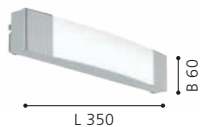

9 002759 977191

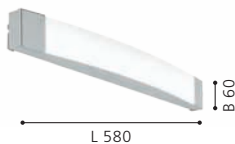

9 002759 996925

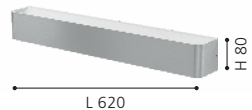



99691

LED

### 99691 SANIA 5

wall light; steel, black, white / plastic, satined  
Wandleuchte; Stahl, schwarz, weiss / Kunststoff, satiniert  
applique; acier, noir, blanc / plastique, satiné

L 620, H 80, A 90

LED

26,5W

warm  
WHITE

3200lm



IP44



9 002759 996918

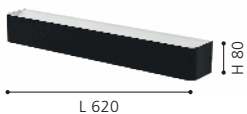



900615

LED



900616

LED



### GEMILIANA

The LED profile of this luminaire can be swiveled for direct or indirect light.

Das LED-Profil dieser Leuchte ist schwenkbar für direktes oder indirektes Licht.

Le profil LED de cette luminaire peut être pivoté pour un éclairage direct ou indirect.



900475

LED

### 900615 GEMILIANA

mirror light; steel, black / plastic, white  
Spiegelleuchte; Stahl, schwarz / Kunststoff, weiss  
applique pour miroir; acier, noir / plastique, blanc

L 450, H 40, A 100



8,9W



1000lm



IP44



### 900616 GEMILIANA

mirror light; steel, chrome / plastic, white  
Spiegelleuchte; Stahl, chrom / Kunststoff, weiss  
applique pour miroir; acier, chrome / plastique, blanc

L 450, H 40, A 100



8,9W



1000lm



IP44



### 900475 VERDELLO

mirror light; plastic, black, brass / plastic, white  
Spiegelleuchte; Kunststoff, schwarz, messing / Kunststoff, weiss  
applique pour miroir; plastique, noir, laiton / plastique, blanc

L 600, B 60, H 105



5W



750lm



IP44



9 008606 245123



9 008606 245130



9 008606 244126







900476



**VERDELLO**

This luminaire swivels up and down and has a CCT switch on the side.

Die Leuchte ist nach oben und unten schwenkbar und hat einen seitlichen CCT-Schalter.

Cette luminaire pivote de haut en bas et dispose d'un interrupteur CCT sur le côté.



900617



900618



**900476 VERDELLO**

mirror light; plastic, white, chrome / plastic, white  
Spiegelleuchte; Kunststoff, weiss, chrom / Kunststoff, weiss  
applique pour miroir; plastique, blanc, chrome / plastique, blanc

L 600, B 60, H 105



5 W 750lm



9 008606 244133



**900617 ALCUDIA**

mirror light; aluminium, steel, black / plastic, satiné  
Spiegelleuchte; Alu, Stahl, schwarz / Kunststoff, satiniert  
applique pour miroir; aluminium, acier, noir / plastique, satiné

L 420, H 30, A 60



2x 5,5W 1200lm



9 008606 245147



**900618 ALCUDIA**

mirror light; aluminium, steel, chrome / plastic, satiné  
Spiegelleuchte; Alu, Stahl, chrom / Kunststoff, satiniert  
applique pour miroir; aluminium, acier, chrome / plastique, satiné

L 420, H 30, A 60



2x 5,5W 1200lm



9 008606 245154

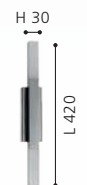

96938

LED



### 96938 CABUS

wall light; steel, chrome / plastic, satiné  
Wandleuchte; Stahl, chrom / Kunststoff, satiniert  
applique; acier, chrome / plastique, satiné

L 580, H 45, A 115

LED

4x 4,5W

warm  
WHITE

1800lm



IP44

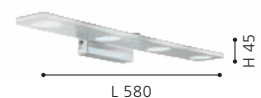



96937



94716



94617



### 96937 CABUS

wall light; steel, chrome / plastic, satined  
Wandleuchte; Stahl, chrom / Kunststoff, satiniert  
applique; acier, chrome / plastique, satiné

L 450, H 45, A 115



3x 4,5W 1350lm



9 002759 969370

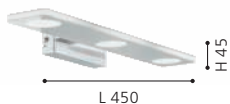

### 94716 CALNOVA

wall light; steel, satin nickel / satin glass, white  
Wandleuchte; Stahl, nickel-matt / Glas satiniert, weiss  
applique; acier, nickel mat / verre satiné, blanc

L 600, B 50, A 85



14W 1900lm



9 002759 947163



### 94617 TORRETTA

mirror light; steel, satin nickel / plastic, white  
Spiegelleuchte; Stahl, nickel-matt / Kunststoff, weiss  
applique pour miroir; acier, nickel mat / plastique, blanc

L 600, B 40, A 75



14W 1900lm



9 002759 946173

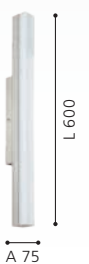



## TRAGACETE 1

These luminaires refer to an on / off button directly on the luminaire.

Diese Leuchten verfügen über einen Ein-/Ausschaltknopf direkt an der Leuchte.

Ces luminaires se réfèrent à un bouton marche / arrêt directement sur le luminaire.



99776

LED



99777

LED



99778

LED

### 99776 TRAGACETE 1

mirror light; plastic, steel, silver, chrome / plastic, white  
Spiegelleuchte; Kunststoff, Stahl, silber, chrom / Kunststoff, weiss  
applique pour miroir; plastique, acier, argent, chrome / plastique, blanc

L 450, B 45, H 45



7,5W



900lm



IP44



9 002759 997762



### 99777 TRAGACETE 1

mirror light; plastic, steel, silver, chrome / plastic, white  
Spiegelleuchte; Kunststoff, Stahl, silber, chrom / Kunststoff, weiss  
applique pour miroir; plastique, acier, argent, chrome / plastique, blanc

L 600, B 45, H 45



15,5W



1900lm



IP44



9 002759 997779



### 99778 TRAGACETE 1

mirror light; plastic, steel, silver, chrome / plastic, white  
Spiegelleuchte; Kunststoff, Stahl, silber, chrom / Kunststoff, weiss  
applique pour miroir; plastique, acier, argent, chrome / plastique, blanc

L 770, B 45, H 45



18,5W



2600lm



IP44



9 002759 997786







99339

LED

### 99339 TRAGACETE 1

mirror light; aluminium, silver, chrome / plastic, white  
 Spiegelleuchte; Alu, silber, chrom / Kunststoff, weiss  
 applique pour miroir; aluminium, argent, chrome / plastique,  
 blanc

L 680, B 55, H 70



15W



1850lm



IP44

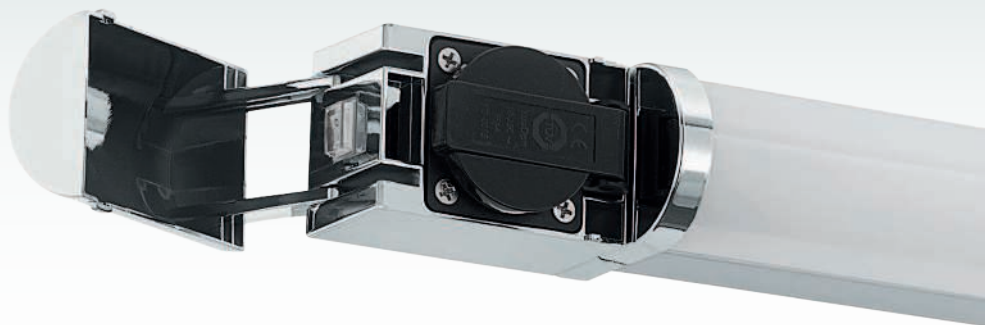

9 002759 993399

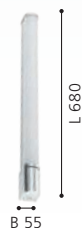

### 99339

This luminaire has a built-in socket.

Diese Leuchte verfügt über eine eingebaute Steckdose.

Cette luminaire a une douille intégrée.



DESIGN  
HIGHLIGHT  
DETAIL



94712



94713



### 94712 GITA 2

wall / ceiling light; cast metal, chrome / plastic, white  
Wand- / Deckenleuchte; Metallguss, chrom / Kunststoff, weiss  
applique / plafonnier; fonte métallique, chrome / plastique,  
blanc

L 350, B 75, H 75



8,3W 900lm



9 002759 947125



### 94713 GITA 2

wall / ceiling light; cast metal, chrome / plastic, white  
Wand- / Deckenleuchte; Metallguss, chrom / Kunststoff, weiss  
applique / plafonnier; fonte métallique, chrome / plastique,  
blanc

L 600, B 75, H 75



16W 1800lm



9 002759 947132

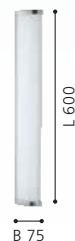

### 94714 GITA 2

wall / ceiling light; cast metal, chrome / plastic, white  
Wand- / Deckenleuchte; Metallguss, chrom / Kunststoff, weiss  
applique / plafonnier; fonte métallique, chrome / plastique,  
blanc

L 900, B 75, H 75



16W 1800lm 8,3W 900lm



9 002759 947149

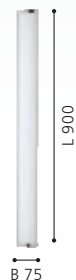



94714

LED





94613

LED







94614



94612



### 94613 TABIANO

mirror light; steel, chrome / plastic, white  
Spiegelleuchte; Stahl, chrom / Kunststoff, weiss  
applique pour miroir; acier, chrome / plastique, blanc

L 605, H 70, A 130



3x 3,2W 900lm

### 94614 TABIANO

mirror light; steel, satin nickel / plastic, white  
Spiegelleuchte; Stahl, nickel-matt / Kunststoff, weiss  
applique pour miroir; acier, nickel mat / plastique, blanc

L 405, H 70, A 130



2x 3,2W 600lm

### 94612 TABIANO

mirror light; steel, chrome / plastic, white  
Spiegelleuchte; Stahl, chrom / Kunststoff, weiss  
applique pour miroir; acier, chrome / plastique, blanc

L 405, H 70, A 130



2x 3,2W 600lm



9 002759 946135



9 002759 946142



9 002759 946128



DESIGN  
HIGHLIGHT  
DETAIL



97081

LED



97082

LED

### 97081 VADUMI

wall light; plastic, chrome / plastic, white  
Wandleuchte; Kunststoff, chrom / Kunststoff, weiss  
applique; plastique, chrome / plastique, blanc

L 400, H 50, A 125



7,5W 850lm

### 97082 VADUMI

wall light; plastic, chrome / plastic, white  
Wandleuchte; Kunststoff, chrom / Kunststoff, weiss  
applique; plastique, chrome / plastique, blanc

L 600, H 50, A 125



11,5W 1350lm

### 97083 VADUMI

wall light; plastic, chrome / plastic, white  
Wandleuchte; Kunststoff, chrom / Kunststoff, weiss  
applique; plastique, chrome / plastique, blanc

L 780, H 50, A 125



15W 1750lm



9 002759 970819



9 002759 970826

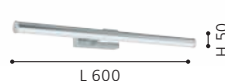

9 002759 970833

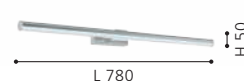



97083

LED





98907

LED



98908

LED



99731

LED

### 98907 PANDELLA 1

mirror light; aluminium, plastic, black / plastic, white  
Spiegelleuchte; Alu, Kunststoff, schwarz / Kunststoff, weiss  
applique pour miroir; aluminium, plastique, noir / plastique, blanc

L 400, H 40, A 120



7,4W 900lm

### 98908 PANDELLA 1

mirror light; aluminium, plastic, black / plastic, white  
Spiegelleuchte; Alu, Kunststoff, schwarz / Kunststoff, weiss  
applique pour miroir; aluminium, plastique, noir / plastique, blanc

L 600, H 40, A 120



11W 1350lm

### 99731 PANDELLA 2

mirror light; aluminium, plastic, black / plastic, white  
Spiegelleuchte; Alu, Kunststoff, schwarz / Kunststoff, weiss  
applique pour miroir; aluminium, plastique, noir / plastique, blanc

L 600, H 40, A 120



11W 1400lm



9 002759 989071



9 002759 989088



9 002759 997311







98677

LED

### 98677 PANDELLA 1

mirror light; aluminium, plastic, black / plastic, white  
 Spiegelleuchte; Alu, Kunststoff, schwarz / Kunststoff, weiss  
 applique pour miroir; aluminium, plastique, noir / plastique, blanc

L 780, H 40, A 120

LED

14W

neutral  
WHITE

1700lm



IP44



DESIGN  
HIGHLIGHT  
DETAIL



9 002759 986773



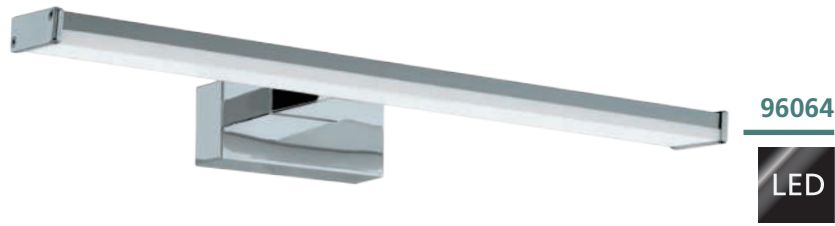

96064

LED



96065

LED



96066

LED

### 96064 PANDELLA 1

mirror light; aluminium, plastic, chrome, silver / plastic, white  
Spiegelleuchte; Alu, Kunststoff, chrom, silber / Kunststoff, weiss  
applique pour miroir; aluminium, plastique, chrome, argent /  
plastique, blanc

L 400, H 40, A 120



7,4W



900lm



IP44



### 96065 PANDELLA 1

mirror light; aluminium, plastic, chrome, silver / plastic, white  
Spiegelleuchte; Alu, Kunststoff, chrom, silber / Kunststoff, weiss  
applique pour miroir; aluminium, plastique, chrome, argent /  
plastique, blanc

L 600, H 40, A 120



11W



1350lm



IP44



### 96066 PANDELLA 1

mirror light; aluminium, plastic, chrome, silver / plastic, white  
Spiegelleuchte; Alu, Kunststoff, chrom, silber / Kunststoff, weiss  
applique pour miroir; aluminium, plastique, chrome, argent /  
plastique, blanc

L 780, H 40, A 120



14W



1700lm



IP44



9 002759 960643



9 002759 960650

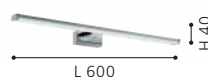

9 002759 960667





99297

LED



### 99297 PANDELLA 1

mirror light; aluminium, plastic, chrome, silver / plastic, white  
Spiegelleuchte; Alu, Kunststoff, chrom, silber / Kunststoff, weiss  
applique pour miroir; aluminium, plastique, chrome, argent /  
plastique, blanc

L 1200, H 40, A 120



13,5W

1750lm

IP44



9 002759 992972

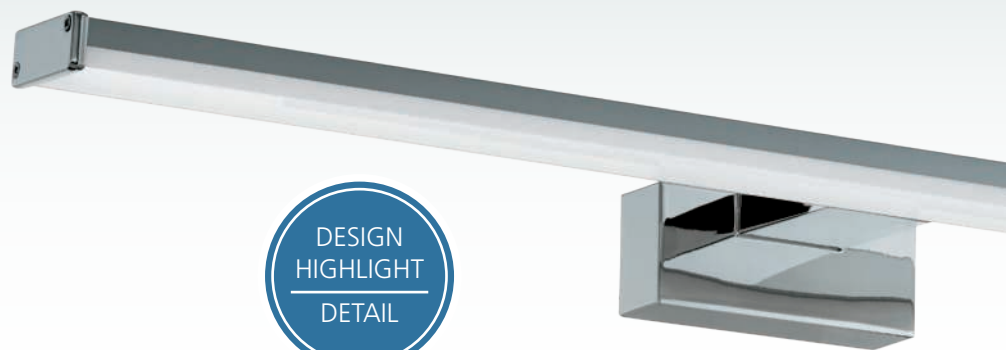
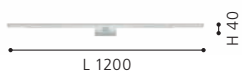

DESIGN  
HIGHLIGHT  
DETAIL



97059

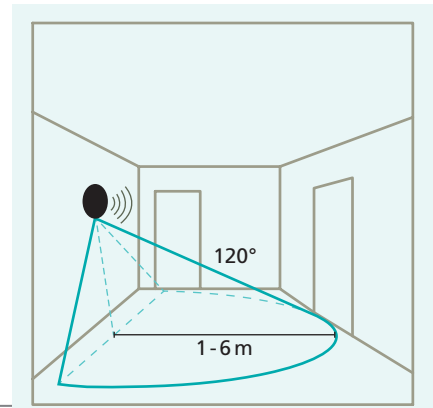

### 97059

This luminaire comes with an integrated motion sensor. The sensor is mounted invisibly behind the casing.

Diese Leuchte ist mit einem integrierten Bewegungssensor ausgestattet. Der Sensor ist unsichtbar hinter dem Gehäuse befestigt.

Ce luminaire vient avec un capteur de mouvement intégré. Le capteur est attaché invisiblement derrière le boîtier.

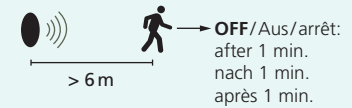
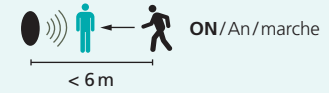

### VINCHIO

These luminaires are delivered with a wiring and connection box that is 19.5 mm deep.

Diese Leuchten werden mit einer Verkabelungs- und Anschlussbox mit einer Tiefe von 19,5 mm geliefert.

Cette luminaires sont livré avec un boîtier de câblage et de connexion d'une profondeur de 19,5 mm.



98501



### 97059 PANDELLA 2

mirror light; plastic, silver, chrome / plastic, white  
Spiegelleuchte; Kunststoff, silber, chrom / Kunststoff, weiss  
applique pour miroir; plastique, argent, chrome / plastique, blanc

L 400, H 75, A 150



### 98501 VINCHIO

mirror light; steel, chrome / plastic, white  
Spiegelleuchte; Stahl, chrom / Kunststoff, weiss  
applique pour miroir; acier, chrome / plastique, blanc

L 400, H 50, A 140



### 98502 VINCHIO

mirror light; steel, chrome / plastic, white  
Spiegelleuchte; Stahl, chrom / Kunststoff, weiss  
applique pour miroir; acier, chrome / plastique, blanc

L 600, H 50, A 140







98502

LED

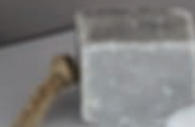

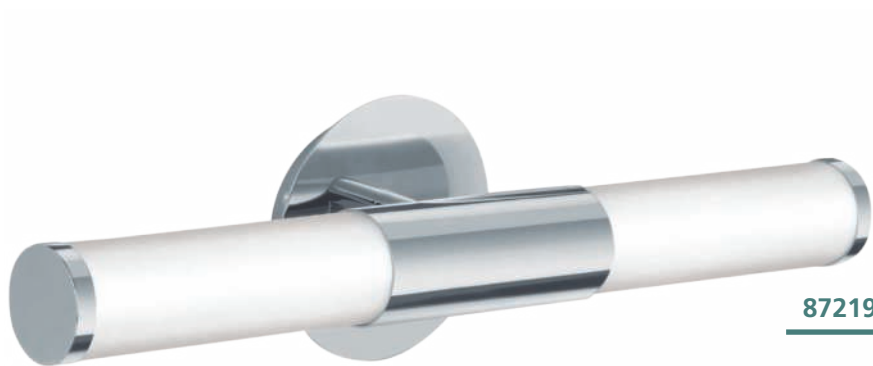

**87219**



**87222**



**83406**



83406 | 87219 | 87222

### 87219 PALMERA

wall light; steel, chrome / glass opal-matt, white  
Wandleuchte; Stahl, chrom / Glas opal-matt, weiss  
applique; acier, chrome / verre opale mat, blanc

L 460, A 110



E14



2x 40W



IP44



9 002759 872199



L 460

### 87222 PALMERA

wall light; steel, satin nickel / glass opal-matt, white  
Wandleuchte; Stahl, nickel-matt / Glas opal-matt, weiss  
applique; acier, nickel mat / verre opale mat, blanc

L 460, A 110



E14



2x 40W



IP44



9 002759 872229



L 460

### 83406 ZOLA

wall light; steel / glass opal-matt, white  
Wandleuchte; Stahl / Glas opal-matt, weiss  
applique; acier / verre opale mat, blanc

L 390, B 80



E14



2x 40W



9 002759 834067



B 80

L 390



94987



85832

### 94987 BARI 1

mirror light; plastic, white / glass grooved, white  
Spiegelleuchte; Kunststoff, weiss / Glas gerillt, weiss  
applique pour miroir; plastique, blanc / verre rainuré, blanc

L 350, B 60, A 85



E14 2x 25W



9 002759 949877



### 85832 STICKER

mirror light; steel, chrome / glass opal-matt, white  
Spiegelleuchte; Stahl, chrom / Glas opal-matt, weiss  
applique pour miroir; acier, chrome / verre opale mat, blanc

L 70, H 115, A 95

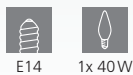

E14 1x 40W



9 002759 858322



94987

This luminaire comes with an integrated power socket.

Diese Leuchte ist mit einer integrierten Steckdose ausgestattet.

Ce luminaire vient avec une prise de courant intégrée.

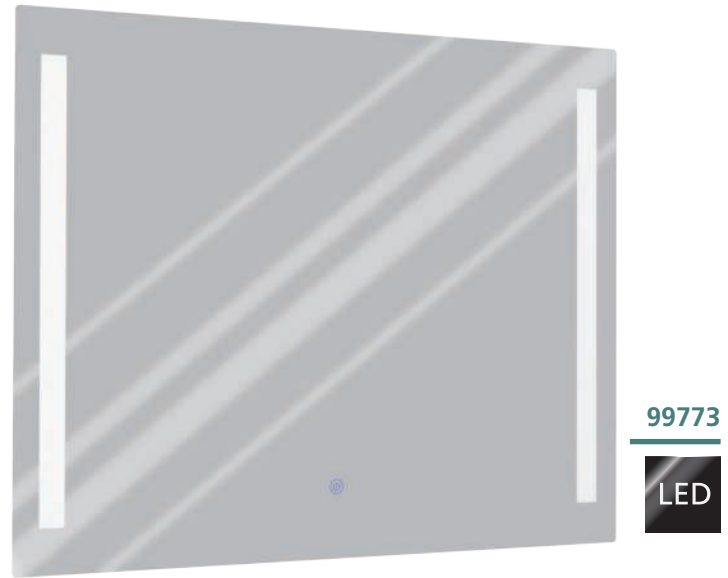

### 99772 BUENAVISTA

mirror light; aluminium, silver / mirror  
Spiegelleuchte; Alu, silber / Spiegel  
applique pour miroir; aluminium, argent / miroir

L 500, H 700, A 30

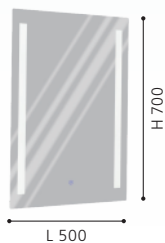
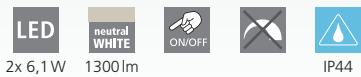

### 99773 BUENAVISTA

mirror light; aluminium, silver / mirror  
Spiegelleuchte; Alu, silber / Spiegel  
applique pour miroir; aluminium, argent / miroir

L 800, H 600, A 30

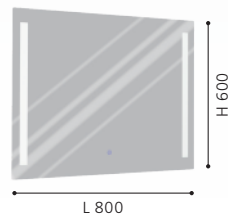
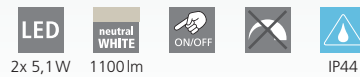

### 99774 BUENAVISTA

mirror light; aluminium, silver / mirror  
Spiegelleuchte; Alu, silber / Spiegel  
applique pour miroir; aluminium, argent / miroir

Ø 600, A 30

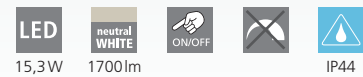





99774

LED



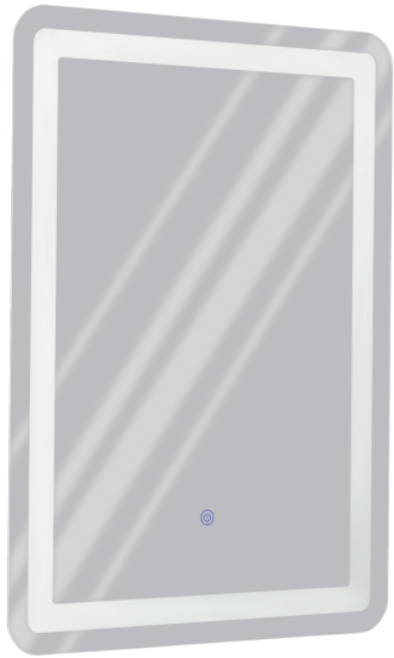

99838

LED

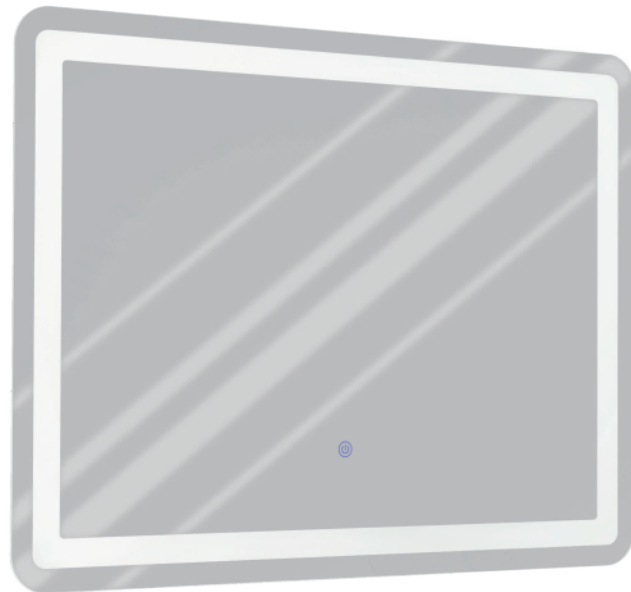

99839

LED

### 99838 BUENAVISTA 1

mirror light; aluminium, silver / mirror  
Spiegelleuchte; Alu, silber / Spiegel  
applique pour miroir; aluminium, argent / miroir

L 500, H 700, A 30



15,7W



1700lm



IP44



9 002759 998387

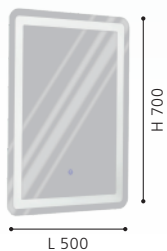

### 99839 BUENAVISTA 1

mirror light; aluminium, silver / mirror  
Spiegelleuchte; Alu, silber / Spiegel  
applique pour miroir; aluminium, argent / miroir

L 800, H 600, A 30



18,6W



2030lm



IP44



9 002759 998394

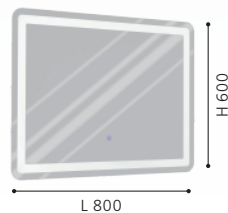

### 99853 BUENAVISTA 2

mirror light; aluminium, silver / mirror  
Spiegelleuchte; Alu, silber / Spiegel  
applique pour miroir; aluminium, argent / miroir

L 500, H 700, A 30



4x 7,1W



3000lm



IP44



9 002759 998530





99853



99854



### 99854 BUENAVISTA 2

mirror light; aluminium, silver / mirror  
Spiegelleuchte; Alu, silber / Spiegel  
applique pour miroir; aluminium, argent / miroir

L 800, H 600, A 30



4x 6,2 W



2600 lm



IP44



9 002759 998547

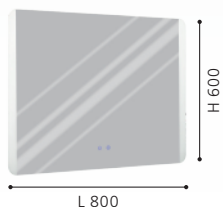

### BUENAVISTA 2

The additional anti-fog function prevents the mirror from fogging up and ensures a clear view after showering.

Die zusätzliche Anti-Fog-Funktion verhindert das Beschlagen des Spiegels und sorgt für eine klare Sicht nach dem Duschen.

La fonction antibuée supplémentaire empêche le miroir de s'embuer et assure une vue dégagée après la douche.

# SPOT & TRACK LUMINAIRES

SPOT- & SCHIENENLEUCHTEN  
SPOTS & LUMINAIRES SUR RAIL

## SYSTEMATIC LIGHTING

Our spot & track luminaires set specific highlights while optimally lighting your living rooms. No matter whether you prefer a modern or a traditional look – our range will fit any taste.

## BELEUCHTUNG MIT SYSTEM

Mit unseren Spot- & Schienenleuchten setzen Sie gezielt Lichtakzente und sorgen zugleich für eine optimale Ausleuchtung Ihrer Wohnräume. Egal ob modern oder traditionell - unser Sortiment trifft jeden Geschmack.



## UN ÉCLAIRAGE AVEC SYSTÈME











































Nos spots et nos luminaires sur rail vous permettent d'offrir des accents ponctuels de lumière et assurent parallèlement un éclairage optimal de vos pièces d'habitat. Qu'ils soient modernes ou traditionnels - notre gamme répond à tous les goûts.





# OVERVIEW

## SPOT & TRACK LUMINAIRES

							
TOWNSHEND 3 p. 660-663	BATALLAS p. 664-665	COTORRO p. 667	ESTEPERRA p. 669	VALBIANO p. 670	VILLABATE p. 671	POLLICA p. 672	BERREGAS p. 674
							
CONSACA p. 676	CASIBARE p. 678	COSWARTH p. 680	CAROVIGNO p. 682	SAMBATELLO p. 684-687	TABILLANO p. 688	ZAPATA 1 p. 690	ZAPATA p. 693
							
SERAS 1 p. 694-695	SERAS p. 696-697, 700-701	SERAS 2 p. 698-699	DAKAR 1 p. 702-703	ENEA p. 704-705	BARNHAM p. 706-707	NOCITO p. 708-709	BIMEDA p. 710-713
							
LOCANDA p. 714	CAYUCA p. 717	SOREGO p. 718	VERGIANO p. 719	DAVIDA p. 720-721	DAVIDA 1 p. 722-723	SARRIA p. 724-727	CORBERA p. 728
							
TUKON 3 p. 730	ZERACO p. 731	ROTTELO p. 732-733	BUZZ-LED p. 734-739	MAGNUM-LED p. 740-741	MAGNUM LED p. 741	CABO 1 p. 742	VILANOVA p. 742-743
							
CARDILLIO 1 p. 744-745, 747	CARDILLIO 2 p. 746-747	SALTO p. 748-749					



This product is available in different colors and shapes./ Dieser Artikel ist in unterschiedlichen Farben und Formen verfügbar.  
Cet article est disponible en différentes couleurs et formes.





### 33169 TOWNSHEND 3

spot; wood, steel, brown, white  
 Spot; Holz, Stahl, braun, weiss  
 spot; bois, acier, marron, blanc

L 300, B 50



E27

2x 60W

### 33171 TOWNSHEND 3

spot; wood, steel, brown, white  
 Spot; Holz, Stahl, braun, weiss  
 spot; bois, acier, marron, blanc

L 480, B 50



E27

3x 60W

### 33172 TOWNSHEND 3

spot; wood, steel, brown, white  
 Spot; Holz, Stahl, braun, weiss  
 spot; bois, acier, marron, blanc

L 630, B 50



E27

4x 60W



9 002759 331696

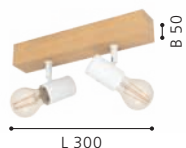

L 300



9 002759 331719

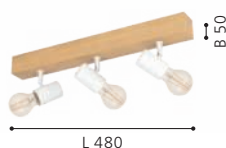

L 480



9 002759 331726

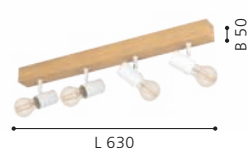

L 630





**33172**



**33168**

**33168 TOWNSHEND 3**

spot; wood, steel, brown, white  
 Spot; Holz, Stahl, braun, weiss  
 spot; bois, acier, marron, blanc

L 165, B 50



E27 1x 10W



9 002759 331689

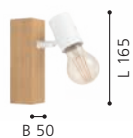



**98112 TOWNSHEND 3**

spot; wood, steel, brown, black  
 Spot; Holz, Stahl, braun, schwarz  
 spot; bois, acier, marron, noir

L 300, B 50



**98113 TOWNSHEND 3**

spot; wood, steel, brown, black  
 Spot; Holz, Stahl, braun, schwarz  
 spot; bois, acier, marron, noir

L 480, B 50



**98114 TOWNSHEND 3**

spot; wood, steel, brown, black  
 Spot; Holz, Stahl, braun, schwarz  
 spot; bois, acier, marron, noir

L 630, B 50

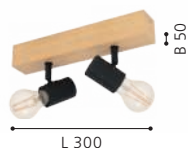





98114



98111

**98111 TOWNSHEND 3**

spot; wood, steel, brown, black  
 Spot; Holz, Stahl, braun, schwarz  
 spot; bois, acier, marron, noir

L 165, B 50





99488



99489



99491



### 99488 BATALLAS

spot; wood, steel, brown, black / fabric, black, white  
 Spot; Holz, Stahl, braun, schwarz / Textil, schwarz, weiss  
 spot; bois, acier, marron, noir / tissu, noir, blanc

L 100, H 170, A 205



E27



1x 10W



9 002759 994884

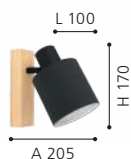

### 99489 BATALLAS

spot; wood, steel, brown, black / fabric, black, white  
 Spot; Holz, Stahl, braun, schwarz / Textil, schwarz, weiss  
 spot; bois, acier, marron, noir / tissu, noir, blanc

L 300, B 50



E27



2x 10W



9 002759 994891

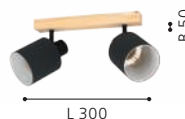

### 99491 BATALLAS

spot; wood, steel, brown, black / fabric, black, white  
 Spot; Holz, Stahl, braun, schwarz / Textil, schwarz, weiss  
 spot; bois, acier, marron, noir / tissu, noir, blanc

L 480, B 50



E27



3x 10W



9 002759 994914

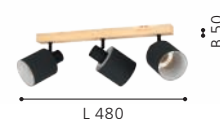





99492



**99492 BATALLAS**

spot; wood, steel, brown, black / fabric, black, white  
 Spot; Holz, Stahl, braun, schwarz / Textil, schwarz, weiss  
 spot; bois, acier, marron, noir / tissu, noir, blanc

L 630, B 50



E27



4x 10W



9 002759 994921

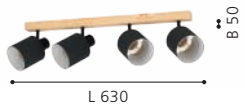



900433





900432



COTORRO



900434



### 900433 COTORRO

spot; wood, steel, brown, black  
Spot; Holz, Stahl, braun, schwarz  
spot; bois, acier, marron, noir

L 840, B 145, H 230



E27 3x 25W

### 900432 COTORRO

spot; wood, steel, brown, black  
Spot; Holz, Stahl, braun, schwarz  
spot; bois, acier, marron, noir

L 540, B 145, H 230



E27 2x 25W

### 900434 COTORRO

spot; wood, steel, brown, black  
Spot; Holz, Stahl, braun, schwarz  
spot; bois, acier, marron, noir

L 145, H 220, A 230



E27 1x 25W



9 008606 243891



9 008606 243884



9 008606 243907

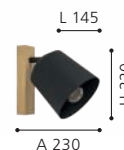





99278





DESIGN  
HIGHLIGHT  
DETAIL



99277



99276

### 99278 ESTEPERRA

spot; steel, black / fabric, black, gold  
Spot; Stahl, schwarz / Textil, schwarz, gold  
spot; acier, noir / tissu, noir, or

L 575, B 90



E27 3x 28W



9 002759 992781



### 99277 ESTEPERRA

spot; steel, black / fabric, black, gold  
Spot; Stahl, schwarz / Textil, schwarz, gold  
spot; acier, noir / tissu, noir, or

L 335, B 90



E27 2x 28W



9 002759 992774



### 99276 ESTEPERRA

spot; steel, black / fabric, black, gold  
Spot; Stahl, schwarz / Textil, schwarz, gold  
spot; acier, noir / tissu, noir, or

H 240, Ø 120



E27 1x 28W



9 002759 992767

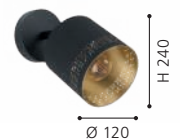



97536

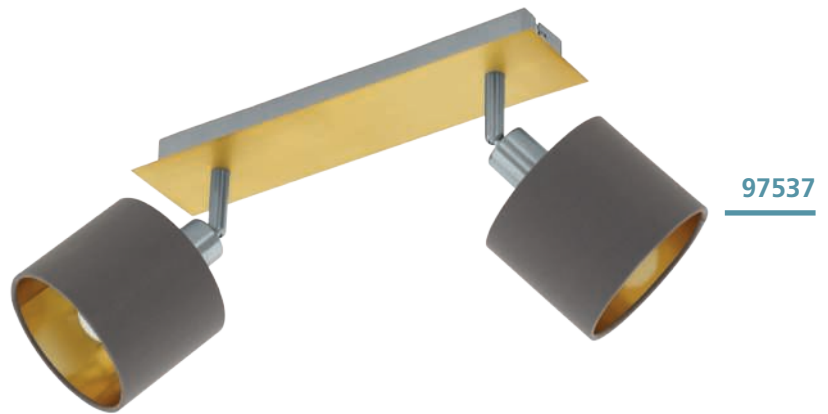

97537



97538

### 97536 VALBIANO

spot; steel, brushed brass, satin nickel / fabric, cappuccino, gold  
Spot; Stahl, messing-gebürstet, nickel-matt / Textil, cappuccino, gold  
spot; acier, laiton brossé, nickel mat / tissu, cappuccino, or

L 110, B 110



E14



1x 7W

### 97537 VALBIANO

spot; steel, brushed brass, satin nickel / fabric, cappuccino, gold  
Spot; Stahl, messing-gebürstet, nickel-matt / Textil, cappuccino, gold  
spot; acier, laiton brossé, nickel mat / tissu, cappuccino, or

L 320, B 70



E14



2x 7W

### 97538 VALBIANO

spot; steel, brushed brass, satin nickel / fabric, cappuccino, gold  
Spot; Stahl, messing-gebürstet, nickel-matt / Textil, cappuccino, gold  
spot; acier, laiton brossé, nickel mat / tissu, cappuccino, or

L 560, B 70



E14



3x 7W



9 002759 975364



L 110



9 002759 975371

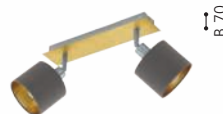

L 320



9 002759 975388



L 560



98139



98141

### 98139 VILLABATE

spot; steel, satin nickel / fabric, grey  
 Spot; Stahl, nickel-matt / Textil, grau  
 spot; acier, nickel mat / tissu, gris

L 335, B 90



E27 2x 10W

### 98141 VILLABATE

spot; steel, satin nickel / fabric, grey  
 Spot; Stahl, nickel-matt / Textil, grau  
 spot; acier, nickel mat / tissu, gris

L 575, B 90



E27 3x 10W



9 002759 981396



L 335

B 90



9 002759 981419



L 575

B 90



98624



98625

### 98624 POLLICA

spot; steel, black / glass vaporized, black-transparent  
Spot; Stahl, schwarz / Glas bedampft, schwarz-transparent  
spot; acier, noir / verre vaporisé, noir transparent

L 65, H 105



E14



1x 10W

### 98625 POLLICA

spot; steel, black / glass vaporized, black-transparent  
Spot; Stahl, schwarz / Glas bedampft, schwarz-transparent  
spot; acier, noir / verre vaporisé, noir transparent

L 365, B 165



E14



2x 28W

### 98626 POLLICA

spot; steel, black / glass vaporized, black-transparent  
Spot; Stahl, schwarz / Glas bedampft, schwarz-transparent  
spot; acier, noir / verre vaporisé, noir transparent

L 640, B 220



E14



4x 28W



9 002759 986247



L 65

H 105



9 002759 986254



L 365

B 165



9 002759 986261



L 640

B 220





98626





**99052**



**99053**

**99052 BERREGAS**

spot; steel, black, chrome / glass vaporized, black-transparent  
 Spot; Stahl, schwarz, chrom / Glas bedampft, schwarz-transparent  
 spot; acier, noir, chrome / verre vaporisé, noir transparent

Ø 110



E27 1x 28W

**99053 BERREGAS**

spot; steel, black, chrome / glass vaporized, black-transparent  
 Spot; Stahl, schwarz, chrom / Glas bedampft, schwarz-transparent  
 spot; acier, noir, chrome / verre vaporisé, noir transparent

L 440, B 110



E27 2x 40W

**99054 BERREGAS**

spot; steel, black, chrome / glass vaporized, black-transparent  
 Spot; Stahl, schwarz, chrom / Glas bedampft, schwarz-transparent  
 spot; acier, noir, chrome / verre vaporisé, noir transparent

L 775, B 110



E27 3x 40W



9 002759 990527



9 002759 990534



9 002759 990541





99054





99711



CONSACA



99713

### 99711 CONSACA

spot; steel, black / glass vaporized, black-transparent  
Spot; Stahl, schwarz / Glas bedampft, schwarz-transparent  
spot; acier, noir / verre vaporisé, noir transparent

L 120, H 220, A 235



E27



1x 28W

### 99713 CONSACA

spot; steel, black / glass vaporized, black-transparent  
Spot; Stahl, schwarz / Glas bedampft, schwarz-transparent  
spot; acier, noir / verre vaporisé, noir transparent

L 780, H 205, A 235



E27



4x 40W

### 99712 CONSACA

spot; steel, black / glass vaporized, black-transparent  
Spot; Stahl, schwarz / Glas bedampft, schwarz-transparent  
spot; acier, noir / verre vaporisé, noir transparent

L 340, H 205, A 235



E27



2x 40W



9 002759 997113

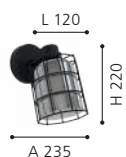

9 002759 997137



9 002759 997120







99712



99517



99518

### 99517 CASIBARE

spot; steel, black  
Spot; Stahl, schwarz  
spot; acier, noir

L 120, H 185, A 190



E27



1x 28W

### 99518 CASIBARE

spot; steel, black  
Spot; Stahl, schwarz  
spot; acier, noir

L 335, H 175, A 180



E27



2x 28W

### 99519 CASIBARE

spot; steel, black  
Spot; Stahl, schwarz  
spot; acier, noir

L 575, H 175, A 180



E27



3x 28W



9 002759 995171



9 002759 995188



9 002759 995195





99519





99075



99076

### 99075 COSWARTH

spot; steel, wood, anthracite, cream-white, brown  
 Spot; Stahl, Holz, anthrazit, creme-weiss, braun  
 spot; acier, bois, gris anthracite, blanc crème, marron

L 480, B 140, H 240



E27



2x 40W

### 99076 COSWARTH

spot; steel, wood, anthracite, cream-white, brown  
 Spot; Stahl, Holz, anthrazit, creme-weiss, braun  
 spot; acier, bois, gris anthracite, blanc crème, marron

L 670, B 140, H 240



E27



3x 40W

### 99074 COSWARTH

spot; steel, wood, anthracite, cream-white, brown  
 Spot; Stahl, Holz, anthrazit, creme-weiss, braun  
 spot; acier, bois, gris anthracite, blanc crème, marron

L 140, H 200



E27



1x 25W



9 002759 990756



L 480



9 002759 990763



L 670



9 002759 990749



L 140





99074





98621



98623

### 98621 CAROVIGNO

spot; steel, black  
Spot; Stahl, schwarz  
spot; acier, noir

L 65, H 105



E14

1x 28W

### 98623 CAROVIGNO

spot; steel, black  
Spot; Stahl, schwarz  
spot; acier, noir

L 640, B 150



E14

4x 40W

### 98622 CAROVIGNO

spot; steel, black  
Spot; Stahl, schwarz  
spot; acier, noir

L 365, B 150



E14

2x 40W



9 002759 986216

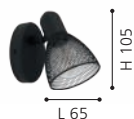

9 002759 986230



9 002759 986223







98622





98134



98135



98137

### 98134 SAMBATELLO

spot; wood, steel, brown, silver / steel, silver  
 Spot; Holz, Stahl, braun, silber / Stahl, silber  
 spot; bois, acier, marron, argent / acier, argent

L 150, H 220, A 240



E27



1x 40W



9 002759 981341

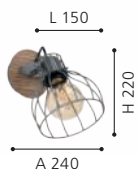

### 98135 SAMBATELLO

spot; wood, steel, brown, silver / steel, silver  
 Spot; Holz, Stahl, braun, silber / Stahl, silber  
 spot; bois, acier, marron, argent / acier, argent

L 335, B 90



E27



2x 40W



9 002759 981358



### 98137 SAMBATELLO

spot; wood, steel, brown, silver / steel, silver  
 Spot; Holz, Stahl, braun, silber / Stahl, silber  
 spot; bois, acier, marron, argent / acier, argent

L 795, B 90



E27



4x 40W



9 002759 981372







98136

### 98136 SAMBATELLO

spot; wood, steel, brown, silver / steel, silver  
Spot; Holz, Stahl, braun, silber / Stahl, silber  
spot; bois, acier, marron, argent / acier, argent

L 575, B 90



E27



3x 40W



9 002759 981365





900382



900383



900384

### 900382 SAMBATELLO

spot; steel, wood, black, brushed brass  
 Spot; Stahl, Holz, schwarz, messing-gebürstet  
 spot; acier, bois, noir, laiton brossé

L 260, B 150, H 220



E27 1x 40W

### 900383 SAMBATELLO

spot; steel, wood, black, brushed brass  
 Spot; Stahl, Holz, schwarz, messing-gebürstet  
 spot; acier, bois, noir, laiton brossé

L 480, B 280, H 260



E27 2x 40W

### 900384 SAMBATELLO

spot; steel, wood, black, brushed brass  
 Spot; Stahl, Holz, schwarz, messing-gebürstet  
 spot; acier, bois, noir, laiton brossé

L 700, B 280, H 260



E27 3x 40W



9 008606 243631



L 260



9 008606 243648

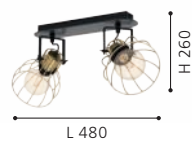

L 480



9 008606 243655



L 700



### 98763 TABILLANO

spot; steel, black  
Spot; Stahl, schwarz  
spot; acier, noir

L 440, B 110



E27

2x 40W

### 98764 TABILLANO

spot; steel, black  
Spot; Stahl, schwarz  
spot; acier, noir

L 775, B 110



E27

3x 40W

### 98762 TABILLANO

spot; steel, black  
Spot; Stahl, schwarz  
spot; acier, noir

Ø 110



E27

1x 40W



9 002759 987633

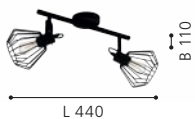

9 002759 987640



9 002759 987626







98762





32765

LED



32767

LED

### 32765 ZAPATA 1

spot; steel, black / glass, amber  
Spot; Stahl, schwarz / Glas, amber  
spot; acier, noir / verre, ambre

Ø 60



G9



1x 3W



1x  
warm  
WHITE  
320lm



9 002759 327651



### 32767 ZAPATA 1

spot; steel, black / glass, amber  
Spot; Stahl, schwarz / Glas, amber  
spot; acier, noir / verre, ambre

L 635, B 65



G9



4x 3W



4x  
warm  
WHITE  
320lm



9 002759 327675



L 635

### 32766 ZAPATA 1

spot; steel, black / glass, amber  
Spot; Stahl, schwarz / Glas, amber  
spot; acier, noir / verre, ambre

L 360, B 65



G9



2x 3W



2x  
warm  
WHITE  
320lm



9 002759 327668



L 360



32766

LED





95547

LED





95546

LED



95545

LED

DESIGN  
HIGHLIGHT  
DETAIL

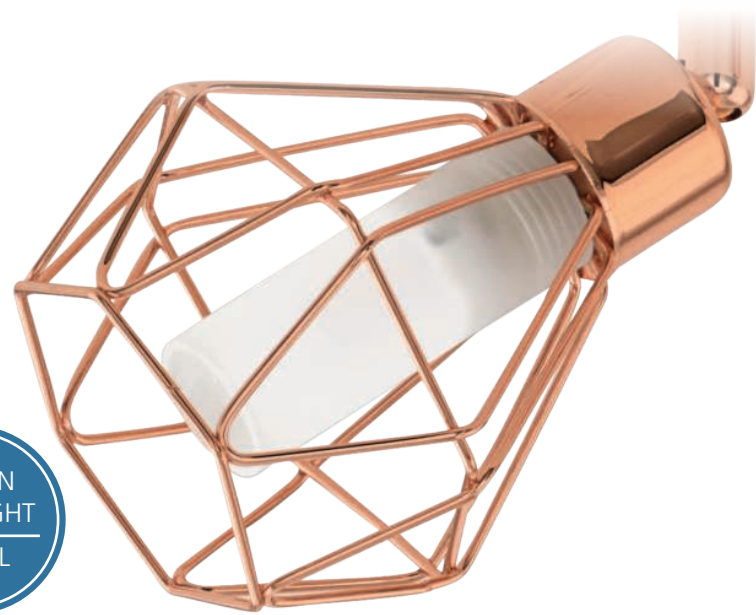

### 95547 ZAPATA

spot; steel, copper / satin glass, white  
Spot; Stahl, kupfer / Glas satiniert, weiss  
spot; acier, cuivre / verre satiné, blanc

L 515, B 65

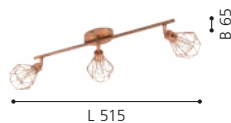
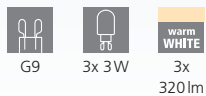

### 95546 ZAPATA

spot; steel, copper / satin glass, white  
Spot; Stahl, kupfer / Glas satiniert, weiss  
spot; acier, cuivre / verre satiné, blanc

L 360, B 65

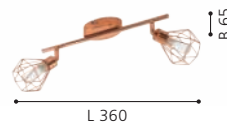
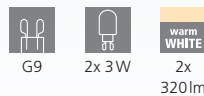

### 95545 ZAPATA

spot; steel, copper / satin glass, white  
Spot; Stahl, kupfer / Glas satiniert, weiss  
spot; acier, cuivre / verre satiné, blanc

Ø 60





98393

LED



98394

LED



98396

LED

### 98393 SERAS 1

spot; steel, white  
Spot; Stahl, weiss  
spot; acier, blanc

Ø 100



GU10



1x 3W



1x  
warm  
WHITE  
250lm

### 98394 SERAS 1

spot; steel, white  
Spot; Stahl, weiss  
spot; acier, blanc

L 370, B 65



GU10



2x 3W



2x  
warm  
WHITE  
250lm

### 98396 SERAS 1

spot; steel, white  
Spot; Stahl, weiss  
spot; acier, blanc

L 770, B 65



GU10



4x 3W



4x  
warm  
WHITE  
250lm



9 002759 983932



Ø 100



9 002759 983949



L 370



9 002759 983963



L 770



98395

LED

**98395 SERAS 1**

spot; steel, white  
Spot; Stahl, weiss  
spot; acier, blanc

L 595, B 65



GU10



3x 3W



warm  
WHITE

3x  
250lm





96552

LED



DESIGN  
HIGHLIGHT  
DETAIL



### 96552 SERAS

spot; steel, nickel-antique, creme  
Spot; Stahl, nickel-antik, creme  
spot; acier, nickel antique, crème

Ø 100



GU10



1x 3W



warm  
WHITE  
1x  
250lm



9 002759 965525



INCL.

Ø 100







96553

LED



96554

LED



96555

LED

**96553 SERAS**

spot; steel, nickel-antique, creme  
Spot; Stahl, nickel-antik, creme  
spot; acier, nickel antique, crème

L 370, B 65

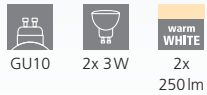

**96554 SERAS**

spot; steel, nickel-antique, creme  
Spot; Stahl, nickel-antik, creme  
spot; acier, nickel antique, crème

L 595, B 65

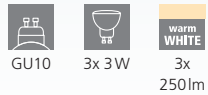

**96555 SERAS**

spot; steel, nickel-antique, creme  
Spot; Stahl, nickel-antik, creme  
spot; acier, nickel antique, crème

L 770, B 65

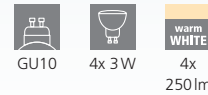



98398

LED



98397

LED

### 98398 SERAS 2

spot; steel, black  
Spot; Stahl, schwarz  
spot; acier, noir

L 370, B 65



GU10



2x 3W



warm  
WHITE

2x

250lm



9 002759 983987





98399

LED



98408

LED

### 98397 SERAS 2

spot; steel, black  
Spot; Stahl, schwarz  
spot; acier, noir

Ø 100

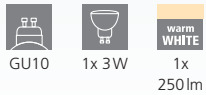

### 98399 SERAS 2

spot; steel, black  
Spot; Stahl, schwarz  
spot; acier, noir

L 595, B 65

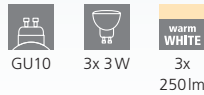

### 98408 SERAS 2

spot; steel, black  
Spot; Stahl, schwarz  
spot; acier, noir

L 770, B 65

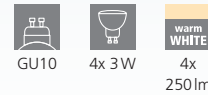



900169

LED



900171

LED



900173

LED

### 900169 SERAS

spot; steel, brushed brass, gold  
Spot; Stahl, messing-gebürstet, gold  
spot; acier, laiton brossé, or

Ø 100



GU10



1x 3W



1x  
warm  
WHITE  
250lm

### 900171 SERAS

spot; steel, brushed brass, gold  
Spot; Stahl, messing-gebürstet, gold  
spot; acier, laiton brossé, or

L 370, B 65



GU10



2x 3W



2x  
warm  
WHITE  
250lm

### 900173 SERAS

spot; steel, brushed brass, gold  
Spot; Stahl, messing-gebürstet, gold  
spot; acier, laiton brossé, or

L 770, B 65



GU10



4x 3W



4x  
warm  
WHITE  
250lm



9 008606 235643



Ø 100



9 008606 235650



L 370



9 008606 235674



L 770





### 900172 SERAS

spot; steel, brushed brass, gold  
Spot; Stahl, messing-gebürstet, gold  
spot; acier, laiton brossé, or

L 595, B 65



GU10



3x 3W



warm  
WHITE  
3x  
250lm



9 008606 235667

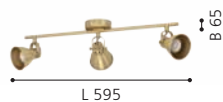



88472

DESIGN  
HIGHLIGHT  
DETAIL



88473



### 88472 DAKAR 1

spot; steel, satin nickel / glass wiping technique, white  
Spot; Stahl, nickel-matt / Glas Wischtechnik, weiss  
spot; acier, nickel mat / technique de verre essuyé, blanc

L 105, B 65



E14



1x 25W

### 88473 DAKAR 1

spot; steel, satin nickel / glass wiping technique, white  
Spot; Stahl, nickel-matt / Glas Wischtechnik, weiss  
spot; acier, nickel mat / technique de verre essuyé, blanc

L 370, B 100



E14



2x 40W



9 002759 884727



L 105



9 002759 884734



L 370

B 100



88474



88475

### 88474 DAKAR 1

spot; steel, satin nickel / glass wiping technique, white  
 Spot; Stahl, nickel-matt / Glas Wischtechnik, weiss  
 spot; acier, nickel mat / technique de verre essuyé, blanc

L 650, B 100



E14 4x 40W



9 002759 884741



### 88475 DAKAR 1

spot; steel, satin nickel / glass wiping technique, white  
 Spot; Stahl, nickel-matt / Glas Wischtechnik, weiss  
 spot; acier, nickel mat / technique de verre essuyé, blanc

Ø 295



E14 3x 40W



9 002759 884758





90984



90986



90985

### 90984 ENEA

spot; steel, satin nickel / satin glass, white  
Spot; Stahl, nickel-matt / Glas satiniert, weiss  
spot; acier, nickel mat / verre satiné, blanc

L 300, B 70



E14 2x 40W

### 90986 ENEA

spot; steel, satin nickel / satin glass, white  
Spot; Stahl, nickel-matt / Glas satiniert, weiss  
spot; acier, nickel mat / verre satiné, blanc

Ø 265



E14 3x 40W

### 90985 ENEA

spot; steel, satin nickel / satin glass, white  
Spot; Stahl, nickel-matt / Glas satiniert, weiss  
spot; acier, nickel mat / verre satiné, blanc

L 500, B 70



E14 3x 40W



9 002759 909840



9 002759 909864

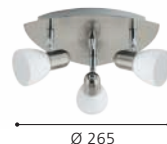

9 002759 909857

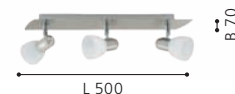





90982

### 90982 ENEA

spot; steel, satin nickel / satin glass, white  
Spot; Stahl, nickel-matt / Glas satiniert, weiss  
spot; acier, nickel mat / verre satiné, blanc

L 190, B 70



E14



1x 25W



9 002759 909826





**94585 BARNHAM**

spot; steel, black, copper  
Spot; Stahl, schwarz, kupfer  
spot; acier, noir, cuivre

L 395, B 70

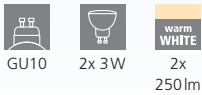

**94586 BARNHAM**

spot; steel, black, copper  
Spot; Stahl, schwarz, kupfer  
spot; acier, noir, cuivre

L 585, B 70

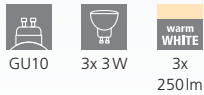

**94587 BARNHAM**

spot; steel, black, copper  
Spot; Stahl, schwarz, kupfer  
spot; acier, noir, cuivre

L 780, B 70

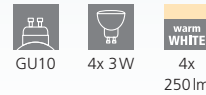





94587

LED



94584

LED

**94584 BARNHAM**

spot; steel, black, copper  
 Spot; Stahl, schwarz, kupfer  
 spot; acier, noir, cuivre

L 165, B 70



GU10



1x 3W



warm  
 WHITE  
 1x  
 250lm



9 002759 945848



INCL.



B 70

L 165



95482

LED



95483

LED



95485

LED

### 95482 NOCITO

spot; steel, black, gold  
Spot; Stahl, schwarz, gold  
spot; acier, noir, or

Ø 110

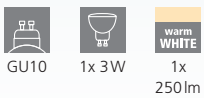

### 95483 NOCITO

spot; steel, black, gold  
Spot; Stahl, schwarz, gold  
spot; acier, noir, or

L 360, B 105

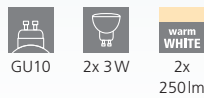

### 95485 NOCITO

spot; steel, black, gold  
Spot; Stahl, schwarz, gold  
spot; acier, noir, or

L 760, B 105

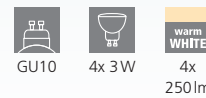

9 002759 954826



9 002759 954833



9 002759 954857







95484

LED

### 95484 NOCITO

spot; steel, black, gold  
Spot; Stahl, schwarz, gold  
spot; acier, noir, or

L 585, B 105



GU10



3x 3W



warm  
WHITE

3x  
250lm



9 002759 954840



DESIGN  
HIGHLIGHT  
DETAIL



31001

LED



31003

LED



31004

LED

### 31001 BIMEDA

spot; steel, white, chrome  
Spot; Stahl, weiss, chrom  
spot; acier, blanc, chrome

Ø 70



GU10



1x 2,8W



1x  
250lm

### 31003 BIMEDA

spot; steel, white, chrome  
Spot; Stahl, weiss, chrom  
spot; acier, blanc, chrome

L 290, H 345



GU10



3x 2,8W



3x  
250lm

### 31004 BIMEDA

spot; steel, white, chrome  
Spot; Stahl, weiss, chrom  
spot; acier, blanc, chrome

L 640, B 100



GU10



4x 2,8W



4x  
250lm



9 002759 310011



Ø 70



9 002759 310035



L 290

H 345



9 002759 310042



L 640

B 100



31002

LED

### 31002 BIMEDA

spot; steel, white, chrome  
Spot; Stahl, weiss, chrom  
spot; acier, blanc, chrome

L 365, B 100



GU10



2x 2,8W



warm  
WHITE  
2x  
250lm



9 002759 310028



INCL.







31005

LED



DESIGN  
HIGHLIGHT  
DETAIL

### 31005 BIMEDA

spot; steel, nickel-nero, chrome  
Spot; Stahl, nickel-nero, chrom  
spot; acier, nickel brillant, chrome

Ø 70



GU10



1x 2,8W



1x  
warm  
WHITE  
250lm







### 31006 BIMEDA

spot; steel, nickel-nero, chrome  
Spot; Stahl, nickel-nero, chrom  
spot; acier, nickel brillant, chrome

L 365, B 100

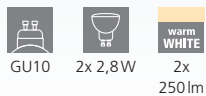

### 31007 BIMEDA

spot; steel, nickel-nero, chrome  
Spot; Stahl, nickel-nero, chrom  
spot; acier, nickel brillant, chrome

L 290, H 345

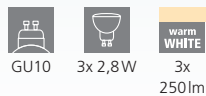

### 31008 BIMEDA

spot; steel, nickel-nero, chrome  
Spot; Stahl, nickel-nero, chrom  
spot; acier, nickel brillant, chrome

L 640, B 100

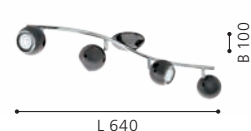
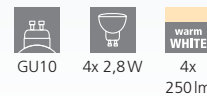

DESIGN  
HIGHLIGHT  
DETAIL



94251

LED

**94251 LOCANDA**

ceiling light; steel, satin nickel, chrome  
Deckenleuchte; Stahl, nickel-matt, chrom  
plafonnier; acier, nickel mat, chrome

L 700, B 660



GU10



5x 2,8W



5x  
warm  
WHITE  
250lm



9 002759 942519



L 700

**94252 LOCANDA**

ceiling light; steel, white, chrome  
Deckenleuchte; Stahl, weiss, chrom  
plafonnier; acier, blanc, chrome

L 700, B 660



GU10



5x 2,8W



5x  
warm  
WHITE  
250lm



9 002759 942526



L 700



94252

LED







900438

LED





900436

LED

DESIGN  
HIGHLIGHT  
DETAIL



900437

LED

### 900438 CAYUCA

spot; steel, black / wood, brown  
Spot; Stahl, schwarz / Holz, braun  
spot; acier, noir / bois, marron

L 580, B 100, H 120



GU10



4x 3W



4x  
warm  
WHITE  
250lm

### 900436 CAYUCA

spot; steel, black / wood, brown  
Spot; Stahl, schwarz / Holz, braun  
spot; acier, noir / bois, marron

L 110, B 105, H 120



GU10



1x 3W



1x  
warm  
WHITE  
250lm

### 900437 CAYUCA

spot; steel, black / wood, brown  
Spot; Stahl, schwarz / Holz, braun  
spot; acier, noir / bois, marron

L 280, B 100, H 120



GU10



2x 3W



2x  
warm  
WHITE  
250lm



9 008606 240005



L 580



9 008606 239986



L 110



9 008606 239993



L 280



900331



900332



900333



### 900331 SOREGO

spot; steel, black  
Spot; Stahl, schwarz  
spot; acier, noir

L 110, B 105, H 120



GU10



1x 3W



1x  
250lm

### 900332 SOREGO

spot; steel, black  
Spot; Stahl, schwarz  
spot; acier, noir

L 280, B 100, H 120



GU10



2x 3W



2x  
250lm

### 900333 SOREGO

spot; steel, black  
Spot; Stahl, schwarz  
spot; acier, noir

L 580, B 100, H 120



GU10



4x 3W



4x  
250lm



L 110



L 280



L 580



97506

LED



97507

LED



97508

LED

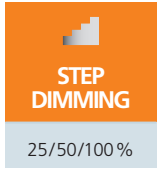

97506

97508

97507

25/50/100%

### 97506 VERGIANO

spot; aluminium, steel, white, satin nickel  
Spot; Alu, Stahl, weiss, nickel-matt  
spot; aluminium, acier, blanc, nickel mat

L 70, H 165



GU10



1x 5W



warm WHITE

1x 400lm



9 002759 975067



### 97507 VERGIANO

spot; aluminium, steel, white, satin nickel  
Spot; Alu, Stahl, weiss, nickel-matt  
spot; aluminium, acier, blanc, nickel mat

L 390, B 70



GU10



2x 5W



warm WHITE

2x 400lm



9 002759 975074

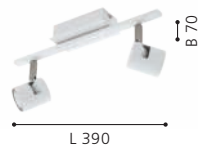

L 390

### 97508 VERGIANO

spot; aluminium, steel, white, satin nickel  
Spot; Alu, Stahl, weiss, nickel-matt  
spot; aluminium, acier, blanc, nickel mat

L 690, B 70



GU10



3x 5W



warm WHITE

3x 400lm



9 002759 975081



L 690



92084

LED



92085

LED



92086

LED

### 92084 DAVIDA

spot; steel, chrome, white  
Spot; Stahl, chrom, weiss  
spot; acier, chrome, blanc

L 165, B 70



GU10



1x 4,6W



warm  
WHITE

1x  
400lm



LED



9 002759 920845



INCL.



L 165

B 70

### 92085 DAVIDA

spot; steel, chrome, white  
Spot; Stahl, chrom, weiss  
spot; acier, chrome, blanc

L 390, B 70



GU10



2x 4,6W



warm  
WHITE

2x  
400lm



INCL.



9 002759 920852



L 390

B 70

### 92086 DAVIDA

spot; steel, chrome, white  
Spot; Stahl, chrom, weiss  
spot; acier, chrome, blanc

L 580, B 70



GU10



3x 4,6W



warm  
WHITE

3x  
400lm



INCL.



9 002759 920869



L 580

B 70





92087

LED

**92087 DAVIDA**

spot; steel, chrome, white  
Spot; Stahl, chrom, weiss  
spot; acier, chrome, blanc

L 780, B 70



GU10



4x 4,6W



4x  
warm  
WHITE  
400lm



9 002759 920876



DESIGN  
HIGHLIGHT  
DETAIL





30833

LED



30832

LED

### 30832 DAVIDA 1

spot; steel, nickel-nero  
Spot; Stahl, nickel-nero  
spot; acier, nickel noir

L 165, B 70



GU10



1x 4,6W



warm  
WHITE

1x

400lm



9 002759 308322



INCL.



B 70

L 165



30834

LED

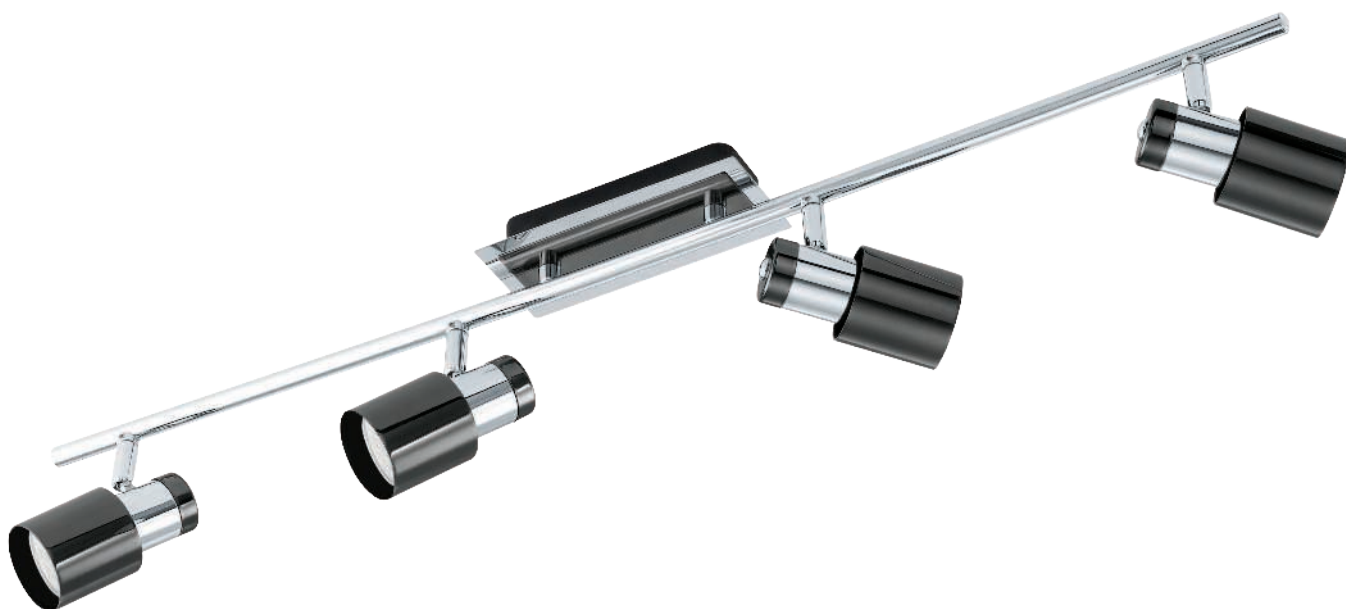

30835

LED

### 30833 DAVIDA 1

spot; steel, nickel-nero  
Spot; Stahl, nickel-nero  
spot; acier, nickel noir

L 390, B 70

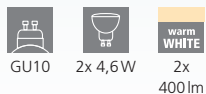

GU10 2x 4,6W 2x warm WHITE 400lm



9 002759 308339



L 390

### 30834 DAVIDA 1

spot; steel, nickel-nero  
Spot; Stahl, nickel-nero  
spot; acier, nickel noir

L 580, B 70

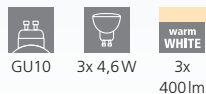

GU10 3x 4,6W 3x warm WHITE 400lm



9 002759 308346



L 580

### 30835 DAVIDA 1

spot; steel, nickel-nero  
Spot; Stahl, nickel-nero  
spot; acier, nickel noir

L 780, B 70

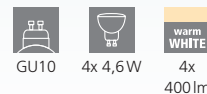

GU10 4x 4,6W 4x warm WHITE 400lm



9 002759 308353



L 780



94962

LED



94958

LED

### 94962 SARRIA

spot; steel, white, chrome  
Spot; Stahl, weiss, chrom  
spot; acier, blanc, chrome

L 240, H 260



GU10



4x 4,5W



warm  
WHITE  
4x  
345lm



9 002759 949624

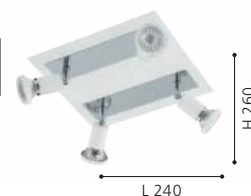





94959

LED



94961

LED

### 94958 SARRIA

spot; steel, white, chrome  
Spot; Stahl, weiss, chrom  
spot; acier, blanc, chrome

L 120, B 60

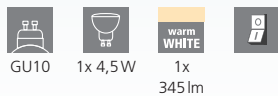

### 94959 SARRIA

spot; steel, white, chrome  
Spot; Stahl, weiss, chrom  
spot; acier, blanc, chrome

L 300, B 70

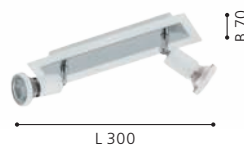
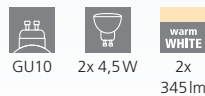

### 94961 SARRIA

spot; steel, white, chrome  
Spot; Stahl, weiss, chrom  
spot; acier, blanc, chrome

L 460, B 70

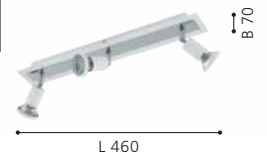
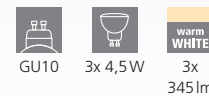



94963

LED



94966

LED



94964

LED

### 94963 SARRIA

spot; steel, black, chrome  
Spot; Stahl, schwarz, chrom  
spot; acier, noir, chrome

L 120, B 60

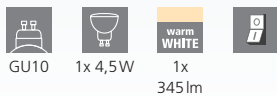

GU10 1x 4,5W 1x 345lm

### 94964 SARRIA

spot; steel, black, chrome  
Spot; Stahl, schwarz, chrom  
spot; acier, noir, chrome

L 300, B 70

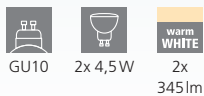

GU10 2x 4,5W 2x 345lm

### 94966 SARRIA

spot; steel, black, chrome  
Spot; Stahl, schwarz, chrom  
spot; acier, noir, chrome

L 240, H 260

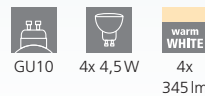

GU10 4x 4,5W 4x 345lm



9 002759 949631



B 60



9 002759 949648



L 300



9 002759 949662



L 240



### 94965 SARRIA

spot; steel, black, chrome  
Spot; Stahl, schwarz, chrom  
spot; acier, noir, chrome

L 460, B 70



GU10



3x 4,5 W



3x  
warm  
WHITE  
345 lm



9 002759 949655



INCL.

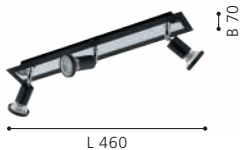

L 460

B 70



DESIGN  
HIGHLIGHT  
DETAIL



93672

LED



93673

LED

### CORBERA

Designer spot series with special spot heads.

Spotsérie mit Spotköpfen in besonderem Design.

Série de spot avec des têtes de spot spéciales.

#### 93672 CORBERA

spot; steel, plastic, chrome  
Spot; Stahl, Kunststoff, chrom  
spot; acier, plastique, chrome

L 120, B 60

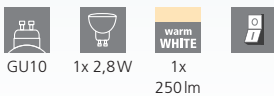

GU10 1x 2,8W 1x 250lm

#### 93673 CORBERA

spot; steel, plastic, chrome  
Spot; Stahl, Kunststoff, chrom  
spot; acier, plastique, chrome

L 390, B 70

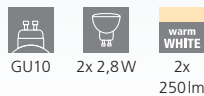

GU10 2x 2,8W 2x 250lm

#### 93674 CORBERA

spot; steel, plastic, chrome  
Spot; Stahl, Kunststoff, chrom  
spot; acier, plastique, chrome

L 585, B 70

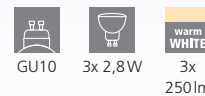

GU10 3x 2,8W 3x 250lm



9 002759 936723



9 002759 936730



9 002759 936747







93674

LED

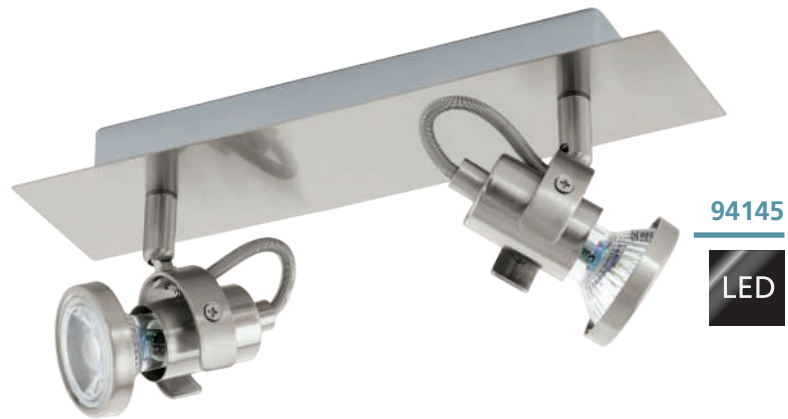

### 94145 TUKON 3

spot; steel, satin nickel  
Spot; Stahl, nickel-matt  
spot; acier, nickel mat

L 280, B 70

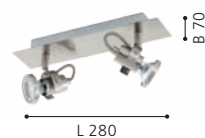
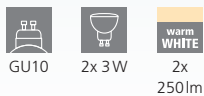

### 94146 TUKON 3

spot; steel, satin nickel  
Spot; Stahl, nickel-matt  
spot; acier, nickel mat

L 460, B 70

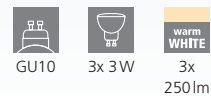

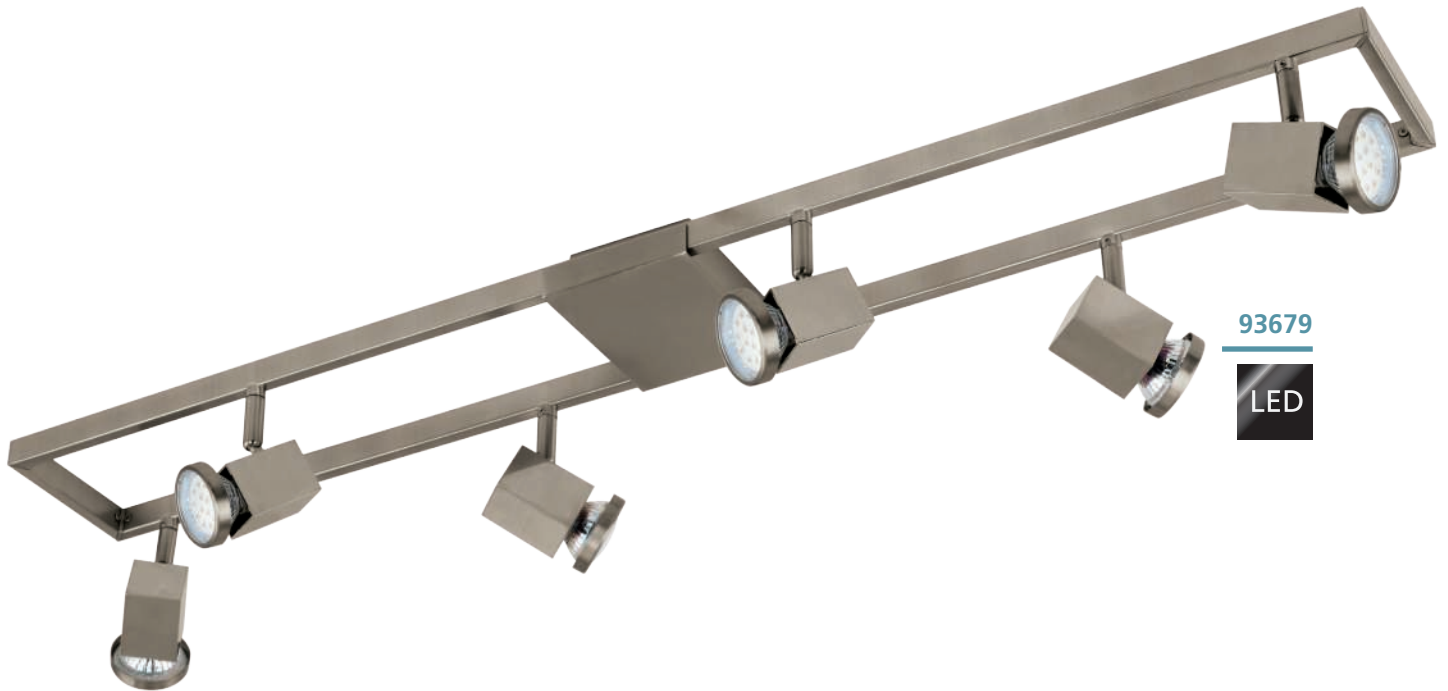

93679

LED

### 93679 ZERACO

spot; steel, plastic, satin nickel  
 Spot; Stahl, Kunststoff, nickel-matt  
 spot; acier, plastique, nickel mat

L 940, B 120



GU10



6x 4,6W



6x  
 warm  
 WHITE  
 400lm

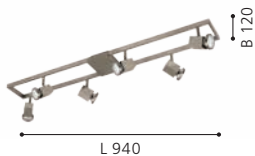



### 90915 ROTTELO

spot; steel, satin nickel, chrome  
Spot; Stahl, nickel-matt, chrom  
spot; acier, nickel mat, chrome

L 280, B 70

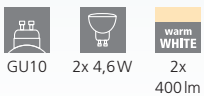

### 90914 ROTTELO

spot; steel, satin nickel, chrome  
Spot; Stahl, nickel-matt, chrom  
spot; acier, nickel mat, chrome

L 120, B 60

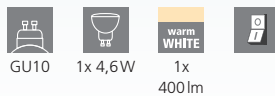

### 90916 ROTTELO

spot; steel, satin nickel, chrome  
Spot; Stahl, nickel-matt, chrom  
spot; acier, nickel mat, chrome

L 260, B 240

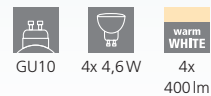





90917



90927



### 90917 ROTTELO

spot; steel, satin nickel, chrome  
 Spot; Stahl, nickel-matt, chrom  
 spot; acier, nickel mat, chrome

L 780, B 70

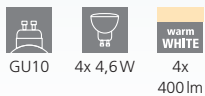

### 90927 ROTTELO

spot; steel, satin nickel, chrome  
 Spot; Stahl, nickel-matt, chrom  
 spot; acier, nickel mat, chrome

L 1160, B 70

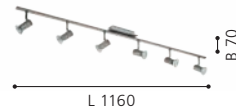
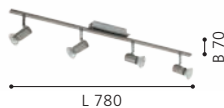
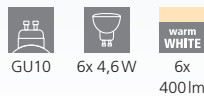



92595

LED



92596

LED



92597

LED

### 92595 BUZZ-LED

spot; steel, satin nickel  
Spot; Stahl, nickel-matt  
spot; acier, nickel mat

Ø 60



GU10



1x 2,8W



1x  
250lm

### 92596 BUZZ-LED

spot; steel, satin nickel  
Spot; Stahl, nickel-matt  
spot; acier, nickel mat

L 285, B 65



GU10



2x 2,8W



2x  
250lm

### 92597 BUZZ-LED

spot; steel, satin nickel  
Spot; Stahl, nickel-matt  
spot; acier, nickel mat

L 485, B 65



GU10



3x 2,8W



3x  
250lm



9 002759 925956



Ø 60



9 002759 925963



L 285

B 65



9 002759 925970



L 485

B 65



92598

LED



92599

LED

### 92598 BUZZ-LED

spot; steel, satin nickel  
Spot; Stahl, nickel-matt  
spot; acier, nickel mat

L 685, B 65

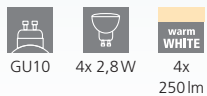

### 92599 BUZZ-LED

spot; steel, satin nickel  
Spot; Stahl, nickel-matt  
spot; acier, nickel mat

L 1050, B 65

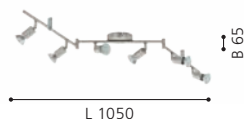
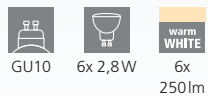



32428

LED



32429

LED



32431

LED

### 32428 BUZZ-LED

spot; steel, black  
Spot; Stahl, schwarz  
spot; acier, noir

Ø 60



GU10



1x 2,8W



1x  
warm  
WHITE  
250lm

### 32429 BUZZ-LED

spot; steel, black  
Spot; Stahl, schwarz  
spot; acier, noir

L 285, B 65



GU10



2x 2,8W



2x  
warm  
WHITE  
250lm

### 32431 BUZZ-LED

spot; steel, black  
Spot; Stahl, schwarz  
spot; acier, noir

L 485, B 65



GU10



3x 2,8W



3x  
warm  
WHITE  
250lm



9 002759 324285



Ø 60



9 002759 324292



L 285

B 65



9 002759 324315



L 485

B 65





32432

LED



32433

LED

### 32432 BUZZ-LED

spot; steel, black  
Spot; Stahl, schwarz  
spot; acier, noir

L 685, B 65



GU10



4x 2,8W



4x  
warm  
WHITE  
250lm



9 002759 324322



L 685

### 32433 BUZZ-LED

spot; steel, black  
Spot; Stahl, schwarz  
spot; acier, noir

L 1050, B 65



GU10



6x 2,8W



6x  
warm  
WHITE  
250lm



9 002759 324339



L 1050



33184

LED



33185

LED



33186

LED

### 33184 BUZZ-LED

spot; steel, brushed brass  
Spot; Stahl, messing-gebürstet  
spot; acier, laiton brossé

Ø 60



GU10



1x 2,8W



1x  
warm  
WHITE  
250lm



9 002759 331849



Ø 60

### 33185 BUZZ-LED

spot; steel, brushed brass  
Spot; Stahl, messing-gebürstet  
spot; acier, laiton brossé

L 285, B 65



GU10



2x 2,8W



2x  
warm  
WHITE  
250lm



9 002759 331856



L 285

B 65

### 33186 BUZZ-LED

spot; steel, brushed brass  
Spot; Stahl, messing-gebürstet  
spot; acier, laiton brossé

L 485, B 65



GU10



3x 2,8W



3x  
warm  
WHITE  
250lm



9 002759 331863



L 485

B 65



33187

LED

### 33187 BUZZ-LED

spot; steel, brushed brass  
Spot; Stahl, messing-gebürstet  
spot; acier, laiton brossé

L 685, B 65



GU10



4x 2,8W



warm  
WHITE  
4x  
250lm



9 002759 331870

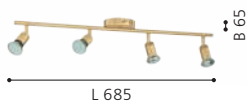



92641

LED



92642

LED



92643

LED

### 92641 MAGNUM-LED

spot; steel, satin nickel, chrome  
Spot; Stahl, nickel-matt, chrom  
spot; acier, nickel mat, chrome

Ø 70



GU10



1x 2,8W



1x  
warm  
WHITE  
250lm

### 92642 MAGNUM-LED

spot; steel, satin nickel, chrome  
Spot; Stahl, nickel-matt, chrom  
spot; acier, nickel mat, chrome

L 330, B 105



GU10



2x 2,8W



2x  
warm  
WHITE  
250lm

### 92643 MAGNUM-LED

spot; steel, satin nickel, chrome  
Spot; Stahl, nickel-matt, chrom  
spot; acier, nickel mat, chrome

L 255, H 295



GU10



3x 2,8W



3x  
warm  
WHITE  
250lm



9 002759 926410



Ø 70



9 002759 926427



L 330

B 105



9 002759 926434



L 255

H 295





95824

LED



92644

LED



92645

LED

### 95824 MAGNUM LED

spot; steel, satin nickel, chrome  
Spot; Stahl, nickel-matt, chrom  
spot; acier, nickel mat, chrome

Ø 180



GU10



3x 2,8W



3x  
warm  
WHITE  
250lm

### 92644 MAGNUM-LED

spot; steel, satin nickel, chrome  
Spot; Stahl, nickel-matt, chrom  
spot; acier, nickel mat, chrome

L 645, B 105



GU10



4x 2,8W



4x  
warm  
WHITE  
250lm

### 92645 MAGNUM-LED

spot; steel, satin nickel, chrome  
Spot; Stahl, nickel-matt, chrom  
spot; acier, nickel mat, chrome

L 1050



GU10



6x 2,8W



6x  
warm  
WHITE  
250lm



9 002759 958244



Ø 180



9 002759 926441



L 645



9 002759 926458



L 1050



93359

LED



93085

LED



93358

93359



94609

### 93085 CABO 1

wall / ceiling light; steel, chrome / satin glass, white, clear  
Wand- / Deckenleuchte; Stahl, chrom / Glas satiniert, weiss, klar  
applique / plafonnier; acier, chrome / verre satiné, blanc, transparent

H 100, Ø 290



GU10



4x 2,8W



4x  
250lm



9 002759 930851



Ø 290

### 93359 VILANOVA

system; aluminium, steel, aluminium, chrome  
System; Alu, Stahl, alu, chrom  
système; aluminium, acier, aluminium, chrome

L 2000, H 200



GU10



5x 2,8W



5x  
250lm



9 002759 933593

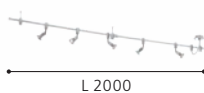

L 2000

### 94609 VILANOVA

accessory; steel, satin nickel  
Zubehör; Stahl, nickel-matt  
accessoire; acier, nickel mat

L 395



9 002759 946098



L 395



93358

LED

### 93358 VILANOVA

system; aluminium, steel, aluminium, chrome / glass, white, clear  
 System; Alu, Stahl, alu, chrom / Glas, weiss, klar  
 système; aluminium, acier, aluminium, chrome / verre, blanc, transparent

L 2000, H 200



GU10



5x 4,6W



warm  
WHITE  
5x  
400lm



9 002759 933586



INCL.



L 2000

### 94609

Set to connect 93359 and 93358 tracks:

- > 250mm Kabel
- > 2 end parts
- > 1 straight connector for direct connection

Verbindungsset für 93359 und 93358 Schienen:

- > 250mm Kabel
- > 2 Endstücke
- > 1 Verbinder für eine direkte Verbindung

Set de connexion pour rails 93359 et 93358:

- > câble de 250mm
- > 2 pièces d'about
- > 1 connecteur pour une connexion directe

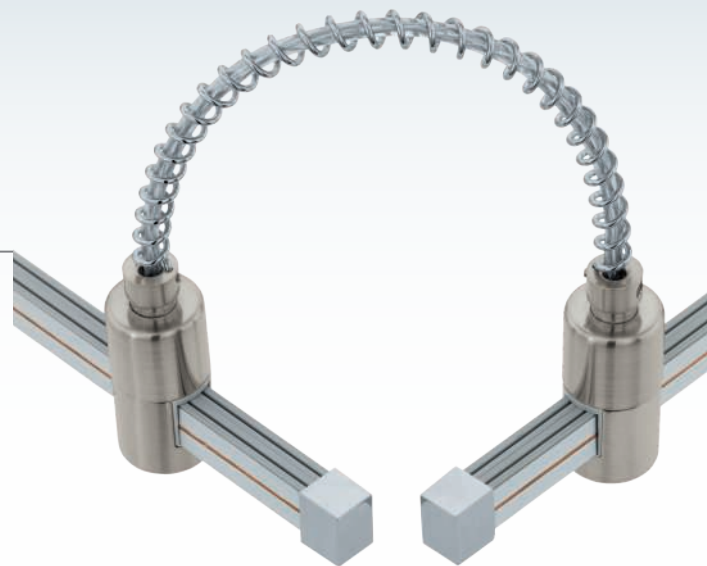



96182

LED



96178

LED



96179

LED

### 96182 CARDILLO 1

spot; aluminium, steel, aluminium, chrome / plastic, satiné  
Spot; Alu, Stahl, alu, chrom / Kunststoff, satiniert  
spot; aluminium, acier, aluminium, chrome / plastique, satiné

L 985, B 85

LED

warm WHITE

LED

warm WHITE



4x 3,2W 1760lm 2x 3,3W 800lm



9 002759 961824



### 96178 CARDILLO 1

spot; aluminium, steel, aluminium, chrome / plastic, satiné  
Spot; Alu, Stahl, alu, chrom / Kunststoff, satiniert  
spot; aluminium, acier, aluminium, chrome / plastique, satiné

L 225, B 65

LED

warm WHITE

LED

warm WHITE



1x 3,2W 440lm 1x 2,2W 260lm



9 002759 961787



### 96179 CARDILLO 1

spot; aluminium, steel, aluminium, chrome / plastic, satiné  
Spot; Alu, Stahl, alu, chrom / Kunststoff, satiniert  
spot; aluminium, acier, aluminium, chrome / plastique, satiné

L 390, B 85

LED

warm WHITE

LED

warm WHITE



2x 3,2W 880lm 1x 3,3W 400lm



9 002759 961794

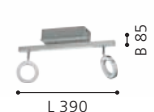





96181

LED

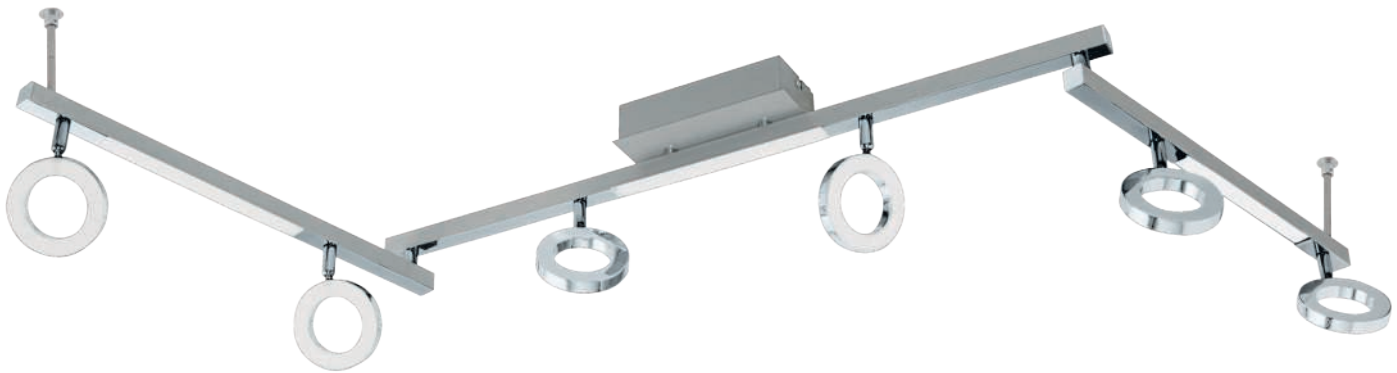

96183

LED



### 96181 CARDILLIO 1

spot; aluminium, steel, aluminium, chrome / plastic, satiné  
Spot; Alu, Stahl, alu, chrom / Kunststoff, satiniert  
spot; aluminium, acier, aluminium, chrome / plastique, satiné

L 690, B 85



9 002759 961817

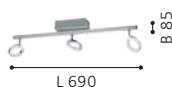

### 96183 CARDILLIO 1

spot; aluminium, steel, aluminium, chrome / plastic, satiné  
Spot; Alu, Stahl, alu, chrom / Kunststoff, satiniert  
spot; aluminium, acier, aluminium, chrome / plastique, satiné

L 1585, B 85



9 002759 961831



### CARDILLIO 1

These luminaires have different lighting sources. Profil lights combined with spot heads create basic lighting as well as accent lighting.

Diese Leuchten verfügen über unterschiedliche Lichtquellen. Profileuchten kombiniert mit Spotköpfen schaffen sowohl Grundlicht als auch Akzentbeleuchtung.

Ces luminaires ont des sources d'éclairage différentes. La combinaison entre un éclairage sur la base du produit et un spot vous permet d'avoir un éclairage général mais aussi directionnel.



900516

LED



900513

LED

### 900516 CARDILLO 2

spot; aluminium, steel, black / plastic, satiné  
Spot; Alu, Stahl, schwarz / Kunststoff, satiniert  
spot; aluminium, acier, noir / plastique, satiné

L 985, B 85, H 175

LED warm WHITE LED warm WHITE

4x 3,2W 1600lm 2x 3,3W 720lm



9 008606 244454



### 900513 CARDILLO 2

spot; aluminium, steel, black / plastic, satiné  
Spot; Alu, Stahl, schwarz / Kunststoff, satiniert  
spot; aluminium, acier, noir / plastique, satiné

L 225, B 65, H 165

LED warm WHITE LED warm WHITE

1x 3,2W 400lm 1x 2,2W 240lm



9 008606 244423





### 900514 CARDILLIO 2

spot; aluminium, steel, black / plastic, satiné  
Spot; Alu, Stahl, schwarz / Kunststoff, satiniert  
spot; aluminium, acier, noir / plastique, satiné

L 385, B 85, H 175



### 900515 CARDILLIO 2

spot; aluminium, steel, black / plastic, satiné  
Spot; Alu, Stahl, schwarz / Kunststoff, satiniert  
spot; aluminium, acier, noir / plastique, satiné

L 385, B 85, H 175



### 900839 CARDILLIO 1

spot; aluminium, steel, black / plastic, satiné  
Spot; Alu, Stahl, schwarz / Kunststoff, satiniert  
spot; aluminium, acier, noir / plastique, satiné

L 1585, B 85, H 200

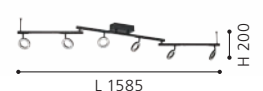



95629

LED



DESIGN  
HIGHLIGHT  
DETAIL

### 95629 SALTO

spot; steel, chrome / plastic, satiné

Spot; Stahl, chrom / Kunststoff, satiniert

spot; acier, chrome / plastique, satiné

L 360, B 120

LED

2x 5,4W

warm  
WHITE

2x  
640lm



9 002759 956295







95628

LED



95631

LED



95632

LED

### 95628 SALTO

spot; steel, chrome / plastic, satiné  
Spot; Stahl, chrom / Kunststoff, satiniert  
spot; acier, chrome / plastique, satiné

Ø 110



1x 5,4W

1x  
640lm



9 002759 956288



### 95631 SALTO

spot; steel, chrome / plastic, satiné  
Spot; Stahl, chrom / Kunststoff, satiniert  
spot; acier, chrome / plastique, satiné

L 560, B 130



3x 5,4W

3x  
640lm



9 002759 956318



### 95632 SALTO

spot; steel, chrome / plastic, satiné  
Spot; Stahl, chrom / Kunststoff, satiniert  
spot; acier, chrome / plastique, satiné

L 760, B 130



4x 5,4W

4x  
640lm



9 002759 956325



# CLIP & PLUG LUMINAIRES

KLEMM- & STECKERLEUCHTEN  
LUMINAIRES À PINCE & SUR PRISE

## LIGHT - VIRTUALLY ANYWHERE

Our clamping and plug-in luminaires inspire with their flexible uses. They serve as pleasant reading lamps or can be positioned for targeted highlighting.

## LICHT - PRAKTISCH ÜBERALL

Unsere Klemm- und Steckerleuchten begeistern durch ihre flexible Verwendbarkeit. Sie dienen als angenehme Lesebeleuchtung oder können zur gezielten Lichtsetzung positioniert werden.



## LA LUMIÈRE - PRATIQUE ET PARTOUT

Nos luminaires à pinces et à fiches ravissent de leurs possibilités flexibles d'utilisation. Ils servent de lumière agréable pour la lecture ou peuvent être positionnés afin d'offrir une lumière ciblée.

# OVERVIEW

## CLIP & PLUG LUMINAIRES



CABADO  
p. 752



FABIO  
p. 752



RICCIO 1  
p. 753



TINEO  
p. 753



MINI 4  
p. 754-755



DAKAR 3  
p. 754



This product is available in different colors and shapes./ Dieser Artikel ist in unterschiedlichen Farben und Formen verfügbar.  
Cet article est disponible en différentes couleurs et formes.



97077

LED

### 97077 CABADO

clamp light; plastic, white  
 Klemmleuchte; Kunststoff, weiss  
 luminaire à pince; plastique, blanc

L 120, B 65, H 420



1,6W



150lm



Li-ion



500mAh



9 002759 970772



H 420

L 120



81262

### 81262 FABIO

clamp light; steel, plastic, white, silver  
 Klemmleuchte; Stahl, Kunststoff, weiss, silber  
 luminaire à pince; acier, plastique, blanc, argent

H 300



E14



1x 40W



9 002759 812621



H 300

### 81265 FABIO

clamp light; steel, plastic, silver  
 Klemmleuchte; Stahl, Kunststoff, silber  
 luminaire à pince; acier, plastique, argent

H 300



E14



1x 40W



9 002759 812652



H 300





94329

LED

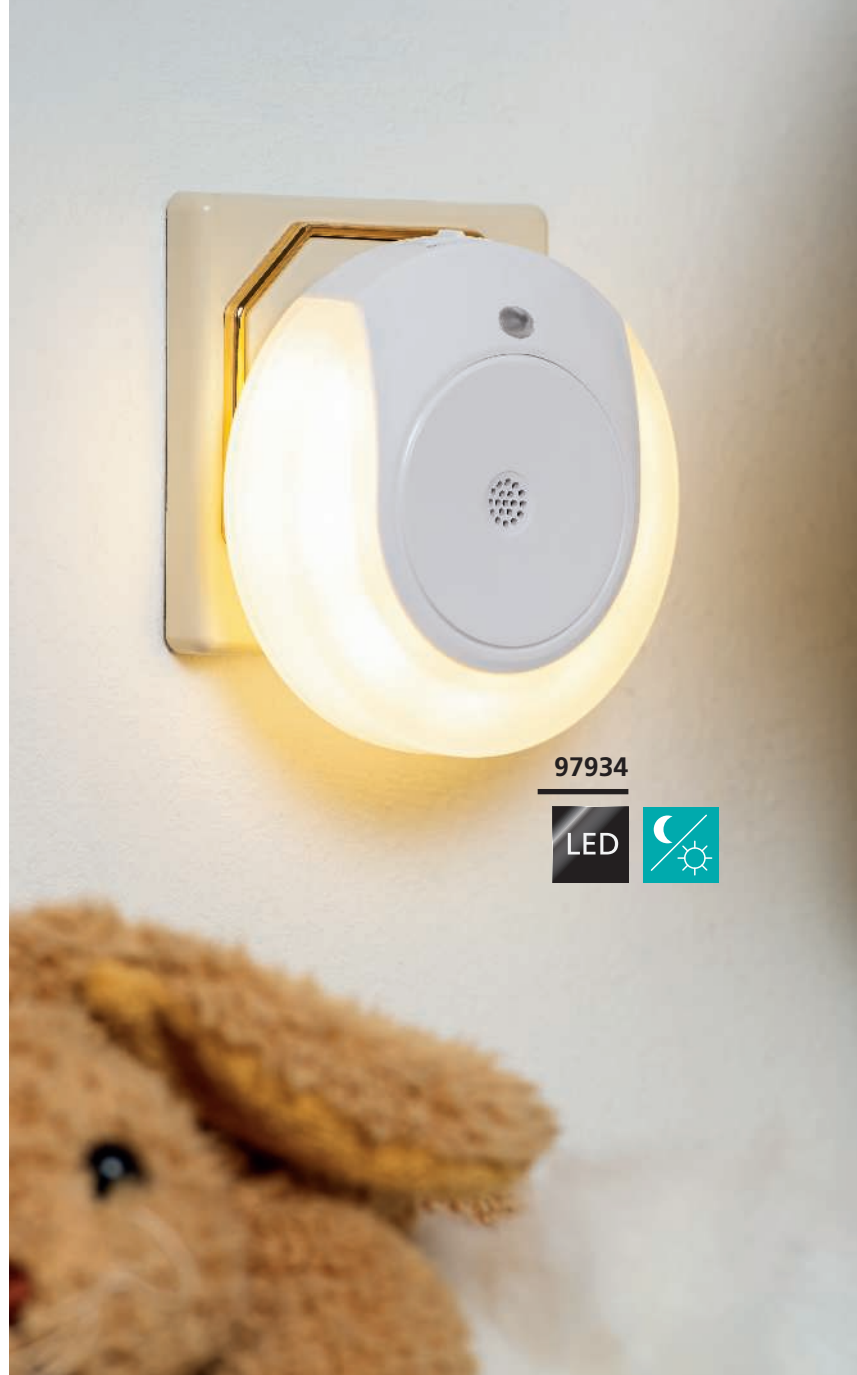

97934

LED

### 94329 RICCIO 1

clamp light; plastic, steel, white, chrome / steel, white, chrome  
 Klemmleuchte; Kunststoff, Stahl, weiss, chrom / Stahl, weiss, chrom  
 luminaire à pince; plastique, acier, blanc, chrome / acier, blanc, chrome

L 180, H 330



9 002759 943295

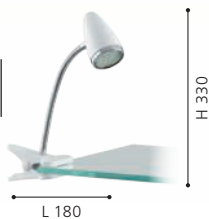

### 97934 TINEO

plug light; plastic, white  
 Steckerleuchte; Kunststoff, weiss  
 luminaire sur prise; plastique, blanc

L 90, B 70, H 90



9 002759 979348



### 97934

This luminaire is equipped with a voice sensor. If an acoustic signal reaches an intensity of 60 dB, the night light will switch on automatically.

Diese Leuchte ist mit einem Akustiksensoren ausgestattet. Bei einem akustischen Signal ab 60 dB schaltet sich das Nachtlicht automatisch ein.

Cette lumière est équipée d'un capteur acoustique. A un signal acoustique dès 60 dB, la lumière de nuit s'intervient automatiquement.



92924

LED



92925

LED



92935

### 92925 MINI 4

plug light; steel, white, chrome  
Steckerleuchte; Stahl, weiss, chrom  
luminaire sur prise; acier, blanc, chrome

L 70, H 100



### 92924 MINI 4

plug light; steel, satin nickel, chrome  
Steckerleuchte; Stahl, nickel-matt, chrom  
luminaire sur prise; acier, nickel mat, chrome

L 70, H 100



### 92935 DAKAR 3

plug light; steel, satin nickel, chrome / plastic, white  
Steckerleuchte; Stahl, nickel-matt, chrom / Kunststoff, weiss  
luminaire sur prise; acier, nickel mat, chrome / plastique, blanc

L 70, H 180, A 280

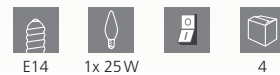



92933

LED

### 92933 MINI 4

plug light; steel, satin nickel, chrome  
Steckerleuchte; Stahl, nickel-matt, chrom  
luminaire sur prise; acier, nickel mat, chrome

L 70, H 180, A 220



GU10



1x 2,8W



1x  
warm  
WHITE  
250lm



4



9 002759 929336



# TABLE & FLOOR LUMINAIRES

TISCH- & STEHLEUCHTEN

LUMINAIRES DE TABLE & LAMPADAIRES

## WE LOVE LIGHT

The range of table and floor luminaires is made up of many different styles and convinces with its diverse uses. The luminaires give your home a comfortable light mood and turn into chic living room accessories.

## WIR STEHEN AUF LICHT

Das Sortiment der Tisch- und Stehleuchten setzt sich aus unterschiedlichen Stilen zusammen und überzeugt mit seinen vielseitigen Einsatzmöglichkeiten. Die Leuchten verleihen Ihrem Zuhause eine gemütliche Lichtstimmung und werden zum schicken Wohnraumaccessoire.

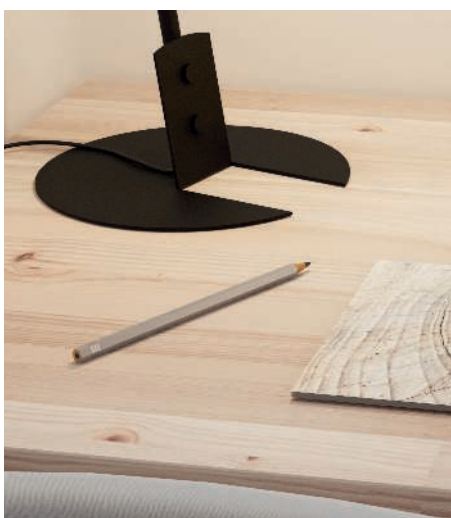

## NOUS NOUS TENONS EN PLEINE LUMIÈRE





























La gamme de luminaires de table et lampadaires est formée de différents styles et persuade par ses multiples possibilités d'application. Les lampes donnent à votre intérieur une lumière conviviale et se transforment en des accessoires d'habitat chics.





# OVERVIEW

## TABLE & FLOOR LUMINAIRES

 FONDACHELLI p. 760	 NOSINO p. 761	 ESTAZIONA p. 761	 CONESA p. 762	 ESPARTAL p. 763	 NADINA p. 763	 REKALDE p. 764	 ONEDA p. 764
 CORTADERAS p. 765	 ARANZOLA p. 765	 BELESER p. 766	 BUDENSEA p. 766	 CARBONERAS p. 767	 PICACHA p. 767	 BARBOTTO p. 768	 DARNIUS p. 768
 BORGILLIO p. 769	 UP 2 p. 770-771	 BAYA LED p. 772-773	 SARRIONE p. 774	 BAYA p. 774	 VILLABATE 1 p. 776-777	 PASTERI p. 777	 CARLTON 2 p. 778
 PEDREGAL 1 p. 779	 CHIETINO 1 p. 780	 MANALBA 1 p. 781	 MANALBA p. 781	 BELLARIVA p. 782	 BELLARIVA 3 p. 783	 TRONDIO p. 783	 TAREGA p. 783
 CAHUAMA p. 784	 BATISTA 3 p. 785	 TURIALDO 1 p. 785	 SWARBY p. 785	 MURNIA p. 786	 PETTO 1 p. 787	 BATABANO p. 787	 ERMUA p. 787
 AMEZAGA p. 788	 MARYVILLA p. 788	 SARONA p. 788	 MANTUNALLE p. 790	 CASTELLATO p. 790	 BILBANA p. 790	 OLIVAL 1 p. 791	 SOLO 2 p. 791
 SOLO 1 p. 792	 SOLO p. 793	 DAMASCO 1 p. 793-794	 SLIM p. 793	 GEO p. 795	 NARANJO p. 797	 DESIERTO p. 797	



This product is available in different colors and shapes./ Dieser Artikel ist in unterschiedlichen Farben und Formen verfügbar.  
Cet article est disponible en différentes couleurs et formes.







**95539**



**95541**



**900187**

### 95539 FONDACHELLI

floor light; steel, satin nickel / fabric, white, silver  
 Stehleuchte; Stahl, nickel-matt / Textil, weiss, silber  
 lampadaire; acier, nickel mat / tissu, blanc, argent

H 1515, Ø 510

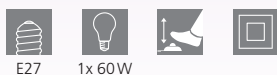

E27 1x 60W



### 95541 FONDACHELLI

floor light; steel, black / fabric, black, copper  
 Stehleuchte; Stahl, schwarz / Textil, schwarz, kupfer  
 lampadaire; acier, noir / tissu, noir, cuivre

H 1515, Ø 510

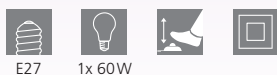

E27 1x 60W



### 900187 FONDACHELLI

floor light; steel, black / fabric, linen, grey  
 Stehleuchte; Stahl, schwarz / Textil, Leinen, grau  
 lampadaire; acier, noir / tissu, lin, gris

H 1515, Ø 510



E27 1x 60W







99101



99015

### 99101 NOSINO

table light; steel, black / fabric, white  
Tischleuchte; Stahl, schwarz / Textil, weiss  
luminaire de table; acier, noir / tissu, blanc

H 580, Ø 220, Base: Ø 220

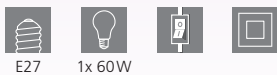

E27 1x 60W



9 002759 991012

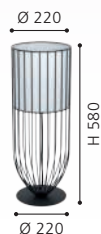

### 99015 ESTAZIONA

floor light; steel, black / fabric, black  
Stehleuchte; Stahl, schwarz / Textil, schwarz  
lampadaire; acier, noir / tissu, noir

L 260, B 235, H 1500, Base: Ø 245

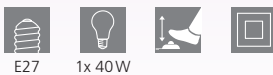

E27 1x 40W



9 002759 990152

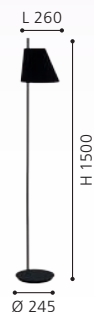



95686



98309

LED

### 95686 CONESA

floor light; steel, satin nickel / fabric, glass, white  
 Stehleuchte; Stahl, nickel-matt / Textil, Glas, weiss  
 lampadaire; acier, nickel mat / tissu, verre, blanc

H 1700, Ø 380, Base: Ø 230



E27



1x 60W



E14



1x 40W



9 002759 956868







92206

### 98309 ESPARTAL

floor light; steel, aluminium, satin nickel, aluminium / fabric, white

Stehleuchte; Stahl, Alu, nickel-matt, alu / Textil, weiss  
 lampadaire; acier, aluminium, nickel mat, aluminium / tissu, blanc

H 1485, Ø 250, Base: Ø 250



9 002759 983093



### 92206 NADINA

floor light; steel, satin nickel / fabric with hoop-and-loop tape, white

Stehleuchte; Stahl, nickel-matt / Textil mit Klettverschluss, weiss  
 lampadaire; acier, nickel mat / tissu avec fermeture velcro, blanc

L 1790, B 380, H 1950, Base: Ø 320

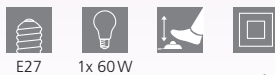

9 002759 922061





**98674**



**900393**



**900394**

### 98674 REKALDE

floor light; steel, black, white  
Stehleuchte; Stahl, schwarz, weiss  
lampadaire; acier, noir, blanc

L 290, B 160, H 1500, Base: Ø 250



E27 1x 40W



9 002759 986742

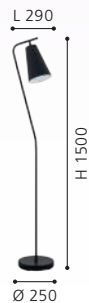

### 900393 ONEDA

table light; steel, black, white  
Tischleuchte; Stahl, schwarz, weiss  
luminaire de table; acier, noir, blanc

L 290, B 145, H 445, Base: Ø 210

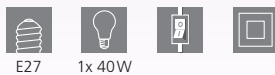

E27 1x 40W



9 008606 243716



### 900394 ONEDA

floor light; steel, black, white  
Stehleuchte; Stahl, schwarz, weiss  
lampadaire; acier, noir, blanc

L 540, B 200, H 1605, Base: Ø 315



E27 1x 40W



9 008606 243723







97806



900134



900135

### 97806 CORTADERAS

floor light; steel, black, gold  
Stehleuchte; Stahl, schwarz, gold  
lampadaire; acier, noir, or

H 1445, Ø 250, Base: Ø 250



### 900134 ARANZOLA

table light; steel, black, white  
Tischleuchte; Stahl, schwarz, weiss  
luminaire de table; acier, noir, blanc

H 450, Ø 300, Base: Ø 115



### 900135 ARANZOLA

floor light; steel, black, white  
Stehleuchte; Stahl, schwarz, weiss  
lampadaire; acier, noir, blanc

L 300, H 1635, Base: Ø 300

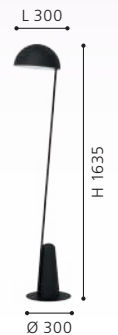



DESIGN  
HIGHLIGHT  
DETAIL

EGLO  
RECOMMENDS  
**110003**  
BELESER

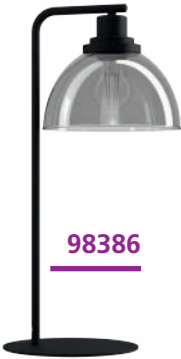

**98386**



**98387**



**99113**

LED

**98386 BELESER**

table light; steel, black / glass vaporized, black-transparent  
Tischleuchte; Stahl, schwarz / Glas bedampft, schwarz-transparent  
luminaire de table; acier, noir / verre vaporisé, noir transparent

L 265, B 205, H 505, Base: Ø 200



E27 1x 60W



9 002759 983864



**98387 BELESER**

floor light; steel, black / glass vaporized, black-transparent  
Stehleuchte; Stahl, schwarz / Glas bedampft, schwarz-transparent  
lampadaire; acier, noir / verre vaporisé, noir transparent

L 260, B 205, H 1505, Base: Ø 220



E27 1x 60W



9 002759 983871



**99113 BUDENSEA**

floor light; cast aluminium, black, white  
Stehleuchte; Aluguss, schwarz, weiss  
lampadaire; fonte d'aluminium, noir, blanc

L 365, B 250, H 1800, Base: B 300, T 250

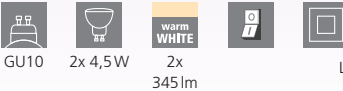

GU10 2x 4,5W warm WHITE 2x 345lm



9 002759 991135





99822

LED

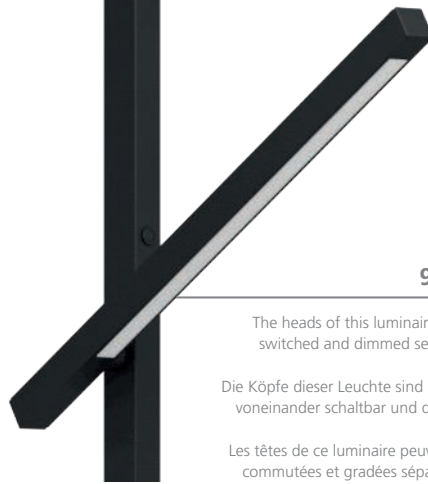

99882

The heads of this luminaire can be switched and dimmed separately.

Die Köpfe dieser Leuchte sind getrennt voneinander schaltbar und dimmbar.

Les têtes de ce luminaire peuvent être commutées et gradées séparément.



99113

This lamp is rotatable.

Diese Leuchte ist drehbar.

Cette lampe est rotative.

0-180°

0-80°

### 99822 CARBONERAS

floor light; steel, black / plastic, transparent  
 Stehleuchte; Stahl, schwarz / Kunststoff, transparent  
 lampadaire; acier, noir / plastique, transparent

L 400, B 250, H 1800, Base: B 330, T 240



6x 3,8W 2400lm 7W 750lm



9 002759 998226

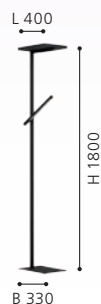

### 99715 PICACHA

floor light; steel, black / plastic, white  
 Stehleuchte; Stahl, schwarz / Kunststoff, weiss  
 lampadaire; acier, noir / plastique, blanc

H 1625, Base: B 150, T 150



29W 3500lm



9 002759 997151



99715

LED



97583

LED



97584

LED



98458

### 97583 BARBOTTO

table light; steel, black, gold  
Tischleuchte; Stahl, schwarz, gold  
luminaire de table; acier, noir, or

H 395, Ø 60, Base: Ø 100



GU10



1x 4,5W



warm WHITE

1x

345lm



9 002759 975838



### 97584 BARBOTTO

floor light; steel, black, gold  
Stehleuchte; Stahl, schwarz, gold  
lampadaire; acier, noir, or

H 1370, Ø 60, Base: Ø 185



GU10



1x 4,5W



warm WHITE

1x

345lm



9 002759 975845



### 98458 DARNIUS

floor light; steel, black, gold  
Stehleuchte; Stahl, schwarz, gold  
lampadaire; acier, noir, or

H 1420, Ø 380, Base: Ø 645



E27



1x 40W



warm WHITE

1x

345lm



9 002759 984588



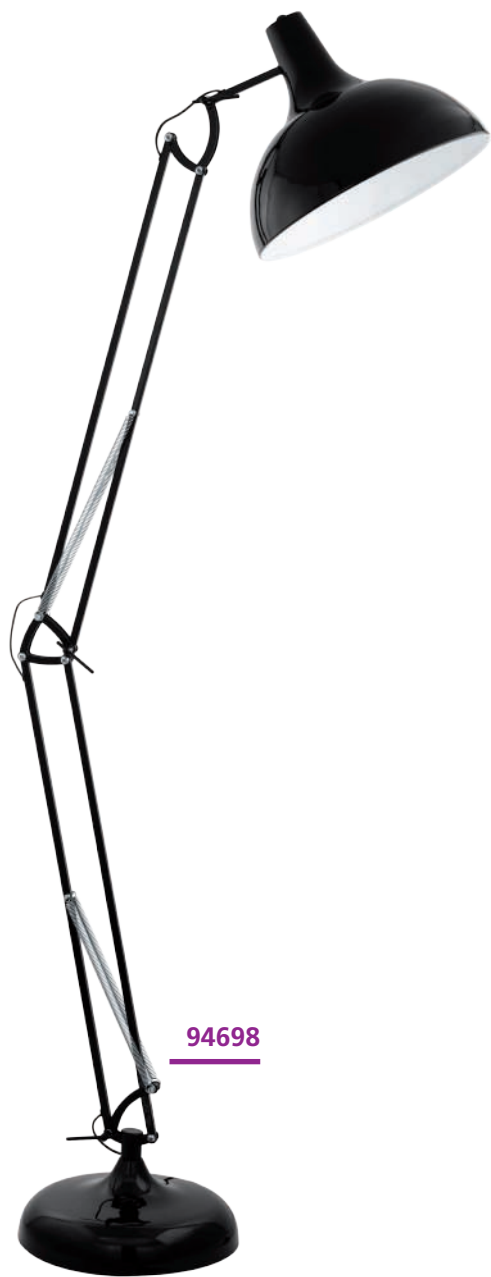

94698



94705

### 94698 BORGILLIO

floor light; steel, black  
Stehleuchte; Stahl, schwarz  
lampadaire; acier, noir

L 380, H 1900, Base: Ø 340

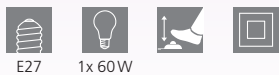

E27 1x 60W

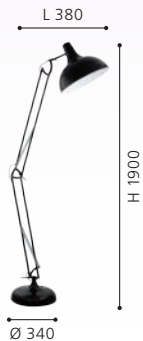

9 002759 946982

### 94705 BORGILLIO

floor light; steel, copper  
Stehleuchte; Stahl, kupfer  
lampadaire; acier, cuivre

L 380, H 1900, Base: Ø 340

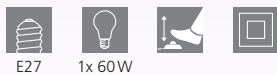

E27 1x 60W

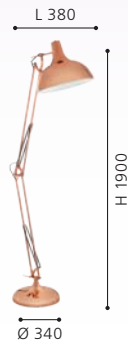

9 002759 947057



**93917**



**82842**



**82843**

### 93917 UP 2

floor light; steel, nickel-nero / plastic, glass, white  
 Stehleuchte; Stahl, nickel-nero / Kunststoff, Glas, weiss  
 lampadaire; acier, nickel noir / plastique, verre, blanc

H 1765, Ø 275, Base: Ø 230

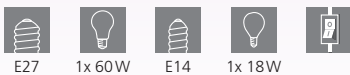

### 82842 UP 2

floor light; steel, satin nickel / plastic, glass, white  
 Stehleuchte; Stahl, nickel-matt / Kunststoff, Glas, weiss  
 lampadaire; acier, nickel mat / plastique, verre, blanc

H 1765, Ø 275, Base: Ø 230



### 82843 UP 2

floor light; steel, brass-matt / plastic, glass, white  
 Stehleuchte; Stahl, messing-matt / Kunststoff, Glas, weiss  
 lampadaire; acier, laiton mat / plastique, verre, blanc

H 1765, Ø 275, Base: Ø 230

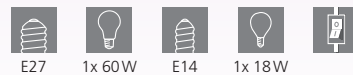



**82844**

DESIGN  
HIGHLIGHT  
DETAIL



### 82844 UP 2

floor light; steel, bronzed / plastic, glass, white  
Stehleuchte; Stahl, brüniert / Kunststoff, Glas, weiss  
lampadaire; acier, brun / plastique, verre, blanc

H 1765, Ø 275, Base: Ø 230



E27



1x 60W



E14



1x 18W



9 002759 828448





93877



93876



93875



### 93877 BAYA LED

floor light; steel, brass / glass, plastic, white, satined  
 Stehleuchte; Stahl, messing / Glas, Kunststoff, weiss, satiniert  
 lampadaire; acier, laiton / verre, plastique, blanc, satiné

L 360, H 1800, Base: Ø 250

LED 20W warm WHITE 1950lm LED 2,5W warm WHITE 240lm LED 2,5W

warm WHITE 250lm



9 002759 938772



### 93876 BAYA LED

floor light; steel, bronzed / glass, plastic, white, satined  
 Stehleuchte; Stahl, brüniert / Glas, Kunststoff, weiss, satiniert  
 lampadaire; acier, brun / verre, plastique, blanc, satiné

L 360, H 1800, Base: Ø 250

LED 20W warm WHITE 1950lm LED 2,5W warm WHITE 240lm LED 2,5W

warm WHITE 250lm



9 002759 938765



### 93875 BAYA LED

floor light; steel, chrome / glass, plastic, white, satined  
 Stehleuchte; Stahl, chrom / Glas, Kunststoff, weiss, satiniert  
 lampadaire; acier, chrome / verre, plastique, blanc, satiné

L 360, H 1800, Base: Ø 250

LED 20W warm WHITE 1950lm LED 2,5W warm WHITE 240lm LED 2,5W

warm WHITE 250lm



9 002759 938758







DESIGN  
HIGHLIGHT  
DETAIL



93874

LED

**93874 BAYA LED**

floor light; steel, satin nickel / glass, plastic, white, satined  
Stehleuchte; Stahl, nickel-matt / Glas, Kunststoff, weiss, satiniert  
lampadaire; acier, nickel mat / verre, plastique, blanc, satiné

L 360, H 1800, Base: Ø 250

- LED**  
20W
- warm WHITE**  
2200lm
- LED**  
2,5W
- warm WHITE**  
250lm
- LED**  
2,5W

- warm WHITE**  
250lm
- 
- 
- 
- 

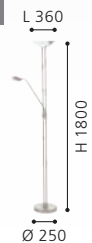



DESIGN  
HIGHLIGHT  
DETAIL



93713  
LED



85974

**93713 SARRIONE**  
floor light; steel, satin nickel / plastic, satined  
Stehleuchte; Stahl, nickel-matt / Kunststoff, satiniert  
lampadaire; acier, nickel mat / plastique, satiné

**85974 BAYA**  
floor light; steel, bronzed / satin glass, white  
Stehleuchte; Stahl, brüniert / Glas satiniert, weiss  
lampadaire; acier, brun / verre satiné, blanc

**85971 BAYA**  
floor light; steel, satin nickel / satin glass, white  
Stehleuchte; Stahl, nickel-matt / Glas satiniert, weiss  
lampadaire; acier, nickel mat / verre satiné, blanc

H 1800, Base: Ø 250

LED 17W warm WHITE 1900lm  
LED 3W warm WHITE 340lm  
LED 4,5W

warm WHITE 500lm



9 002759 937133

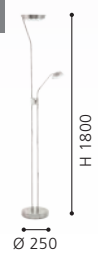

L 440, H 1800, Base: Ø 280

R7S 1x 230W G9 1x 33W



9 002759 859749

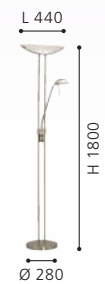

L 440, H 1800, Base: Ø 280

R7S 1x 230W G9 1x 33W



9 002759 859718

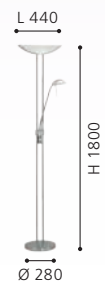



85971





99103

### 99103 VILLABATE 1

table light; steel, black / fabric, black, white  
Tischleuchte; Stahl, schwarz / Textil, schwarz, weiss  
luminaire de table; acier, noir / tissu, noir, blanc

L 185, B 160, H 175



E27



1x 25W







99104



95726



95725

### 99104 VILLABATE 1

table light; steel, satin nickel / fabric, taupe, white  
Tischleuchte; Stahl, nickel-matt / Textil, taupe, weiss  
luminaire de table; acier, nickel mat / tissu, taupe, blanc

L 185, B 160, H 175



E27 1x 25W



9 002759 991043



### 95726 PASTERI

table light; steel, satin nickel / fabric, taupe  
Tischleuchte; Stahl, nickel-matt / Textil, taupe  
luminaire de table; acier, nickel mat / tissu, taupe

H 275, Ø 140, Base: Ø 120



E14 1x 40W



9 002759 957261



### 95725 PASTERI

table light; steel, satin nickel / fabric, white  
Tischleuchte; Stahl, nickel-matt / Textil, weiss  
luminaire de table; acier, nickel mat / tissu, blanc

H 275, Ø 140, Base: Ø 120

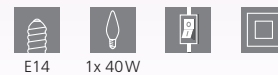

E14 1x 40W



9 002759 957254



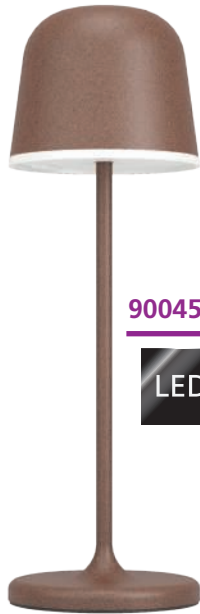

900459

LED

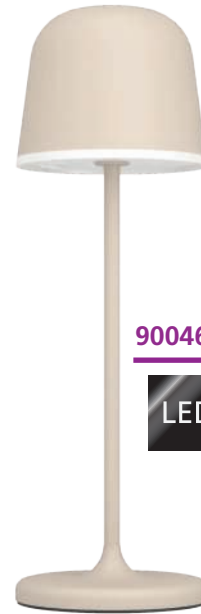

900461

LED

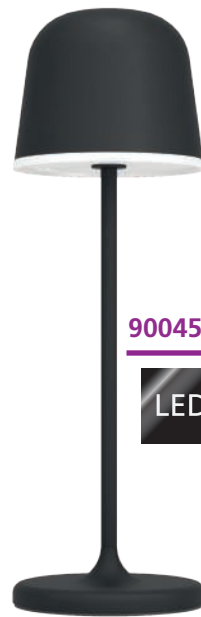

900457

LED

### 900459 MANNERA

table light; aluminium, steel, auburn / plastic, white  
Tischleuchte; Alu, Stahl, rostbraun / Kunststoff, weiss  
luminaire de table; aluminium, acier, brun rouille / plastique, blanc

H 340, Ø 110, Base: Ø 110

LED 2,2W warm WHITE 200lm ACCU Li-ion 1800mAh

IP54



9 008606 244003

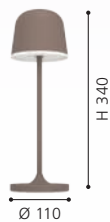

### 900457 MANNERA

table light; aluminium, steel, black / plastic, white  
Tischleuchte; Alu, Stahl, schwarz / Kunststoff, weiss  
luminaire de table; aluminium, acier, noir / plastique, blanc

H 340, Ø 110, Base: Ø 110

LED 2,2W warm WHITE 200lm ACCU Li-ion 1800mAh

IP54



9 008606 243990



### 900461 MANNERA

table light; aluminium, steel, sandy / plastic, white  
Tischleuchte; Alu, Stahl, sandfarben / Kunststoff, weiss  
luminaire de table; aluminium, acier, couleur sable / plastique, blanc

H 340, Ø 110, Base: Ø 110

LED 2,2W warm WHITE 200lm ACCU Li-ion 1800mAh

IP54



9 008606 243983

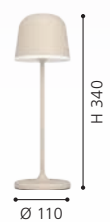



900458

LED

### 900458 MANNERA

table light; aluminium, steel, grey / plastic, white

Tischleuchte; Alu, Stahl, grau / Kunststoff, weiss

luminaire de table; aluminium, acier, gris / plastique, blanc

H 340, Ø 110, Base: Ø 110



2,2W



200lm



Li-ion



1800 mAh



IP54



9 008606 243976

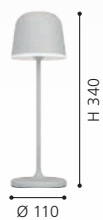



95789



95787



95788

### 95789 CARLTON 2

table light; steel, black / fabric, white  
Tischleuchte; Stahl, schwarz / Textil, weiss  
luminaire de table; acier, noir / tissu, blanc

H 305, Ø 165, Base: Ø 95

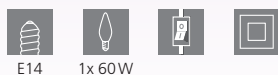

E14 1x 60W



9 002759 957896



### 95787 CARLTON 2

table light; steel, copper / fabric, black, copper  
Tischleuchte; Stahl, kupfer / Textil, schwarz, kupfer  
luminaire de table; acier, cuivre / tissu, noir, cuivre

H 305, Ø 165, Base: Ø 95



E14 1x 60W



9 002759 957872



### 95788 CARLTON 2

table light; steel, brass / fabric, black, gold  
Tischleuchte; Stahl, messing / Textil, schwarz, gold  
luminaire de table; acier, laiton / tissu, noir, or

H 305, Ø 165, Base: Ø 95



E14 1x 60W



9 002759 957889







95185

### 95185 PEDREGAL 1

table light; steel, copper / fabric, black, copper  
Tischleuchte; Stahl, kupfer / Textil, schwarz, kupfer  
luminaire de table; acier, cuivre / tissu, noir, cuivre

H 645, Ø 350, Base: Ø 300



E27



1x 60W



9 002759 951856

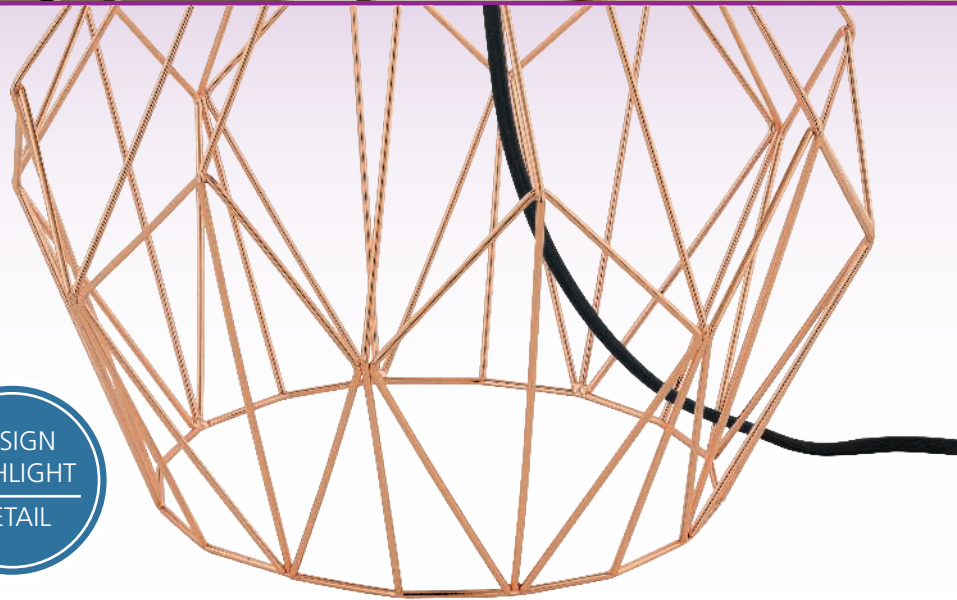
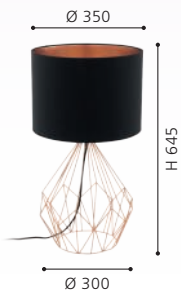



**97516**

**97516 CHIETINO 1**

table light; wood, steel, natural, chrome / fabric, white  
Tischleuchte; Holz, Stahl, natur, chrom / Textil, weiss  
luminaire de table; bois, acier, naturel, chrome / tissu, blanc

H 440, Ø 260, Base: B 235, T 235



E27



1x 60W





99329



99331



95386

### 99329 MANALBA 1

table light; ceramic, silver / fabric, white, silver  
Tischleuchte; Keramik, silber / Textil, weiss, silber  
luminaire de table; céramique, argent / tissu, blanc, argent

H 300, Ø 200, Base: Ø 125

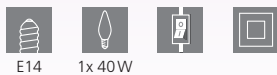

E14 1x 40W



9 002759 993290



### 99331 MANALBA 1

table light; ceramic, gold-coloured / fabric, black, gold  
Tischleuchte; Keramik, goldfarben / Textil, schwarz, gold  
luminaire de table; céramique, or / tissu, noir, or

H 300, Ø 200, Base: Ø 125



E14 1x 40W



9 002759 993313



### 95386 MANALBA

table light; steel, gold / fabric, black, gold  
Tischleuchte; Stahl, gold / Textil, schwarz, gold  
luminaire de table; acier, or / tissu, noir, or

H 380, Ø 250, Base: Ø 160

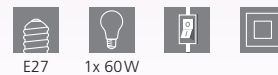

E27 1x 60W



9 002759 953867







97774



97773



### 97774 BELLARIVA

table light; ceramic, grey / fabric, white  
Tischleuchte; Keramik, grau / Textil, weiss  
luminaire de table; céramique, gris / tissu, blanc

H 320, Ø 150, Base: Ø 120



E14 1x 40W



### 97773 BELLARIVA

table light; ceramic, creme-white / fabric, white  
Tischleuchte; Keramik, creme-weiss / Textil, weiss  
luminaire de table; céramique, blanc crème / tissu, blanc

H 320, Ø 150, Base: Ø 120



E14 1x 40W







99332



93046



95527

### 99332 BELLARIVA 3

table light; ceramic, white / fabric, linen, light brown  
Tischleuchte; Keramik, weiss / Textil, Leinen, hellbraun  
luminaire de table; céramique, blanc / tissu, lin, marron transparent

H 360, Ø 200, Base: Ø 160



E27 1x 40W



9 002759 993320



### 93046 TRONDIO

table light; ceramic, white / fabric, white  
Tischleuchte; Keramik, weiss / Textil, weiss  
luminaire de table; céramique, blanc / tissu, blanc

H 270, Ø 150, Base: Ø 120



E14 1x 40W



9 002759 930462



### 95527 TAREGA

table light; wood, concrete, brown, grey / fabric, brown  
Tischleuchte; Holz, Beton, braun, grau / Textil, braun  
luminaire de table; bois, béton, marron, gris / tissu, marron

H 370, Ø 250, Base: Ø 150

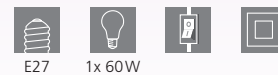

E27 1x 60W



9 002759 955274





99824



99825

### 99824 CAHUAMA

table light; ceramic, light brown / glass, white  
Tischleuchte; Keramik, hellbraun / Glas, weiss  
luminaire de table; céramique, marron clair / verre, blanc

H 300, Ø 275, Base: Ø 105



E27 1x 40W



9 002759 998240



### 99825 CAHUAMA

table light; ceramic, white, black / glass, grey matt  
Tischleuchte; Keramik, weiss, schwarz / Glas, grau matt  
luminaire de table; céramique, blanc, noir / verre, gris mat

H 300, Ø 275, Base: Ø 105



E27 1x 40W



9 002759 998257





97589



97589



900334



98859

### 97589 BATISTA 3

table light; steel, satin nickel / glass wiping technique, white  
Tischleuchte; Stahl, nickel-matt / Glas Wischtechnik, weiss  
luminaire de table; acier, nickel mat / technique de verre essuyé, blanc

H 225, Ø 120, Base: Ø 110



### 900334 TURIALDO 1

table light; wood, steel, black  
Tischleuchte; Holz, Stahl, schwarz  
luminaire de table; bois, acier, noir

H 100, Ø 85



### 98859 SWARBY

table light; cement, grey  
Tischleuchte; Zement, grau  
luminaire de table; ciment, gris

H 120, Ø 100

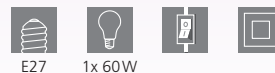





900314



DESIGN  
HIGHLIGHT  
DETAIL



**900314 MURNIA**

table light; steel, black, white  
Tischleuchte; Stahl, schwarz, weiss  
luminaire de table; acier, noir, blanc

L 190, B 165, H 430, Base: Ø 165



E14



1x 40W



9 008606 235421







94513

LED



900396



98837

LED



DESIGN  
HIGHLIGHT  
DETAIL

### 94513 PETTO 1

table light; steel, white  
Tischleuchte; Stahl, weiss  
luminaire de table; acier, blanc

H 135, Ø 105, Base: Ø 90



### 900396 BATABANO

table light; steel, sandy, black  
Tischleuchte; Stahl, sandfarben, schwarz  
luminaire de table; acier, couleur sable, noir

H 275, Ø 180, Base: Ø 160



### 98837 ERMUA

table light; steel, wood, black, brown / plastic, white  
Tischleuchte; Stahl, Holz, schwarz, braun / Kunststoff, weiss  
luminaire de table; acier, bois, noir, marron / plastique, blanc

L 330, B 165, H 505, Base: B 240, T 160





**98864**



**900552**

### 98864 AMEZAGA

table light; steel, black, brass  
Tischleuchte; Stahl, schwarz, messing  
luminaire de table; acier, noir, laiton

L 355, B 160, H 575, Base: Ø 170



E27 1x 10W



9 002759 988647

### 900552 MARYVILLA

table light; steel, bronzed / glass vaporized, clear, gold  
Tischleuchte; Stahl, brüniert / Glas bedampft, klar, gold  
luminaire de table; acier, brun / verre vaporisé, transparent, or

H 230, Ø 170, Base: Ø 130



E27 1x 40W



9 008606 244577

### 900403 SARONA

table light; steel, black, gold  
Tischleuchte; Stahl, schwarz, gold  
luminaire de table; acier, noir, or

H 315, Ø 140, Base: B 140



GU10 1x 4,5W 1x 345lm



9 008606 243785





900403





99369



97333 | 900358



99369



97333



900358

### 99369 MANTUNALLE

table light; steel, black / glass, white  
Tischleuchte; Stahl, schwarz / Glas, weiss  
luminaire de table; acier, noir / verre, blanc

H 400, Ø 200, Base: Ø 220



### 97333 CASTELLATO

table light; steel, black / glass opal-matt, white  
Tischleuchte; Stahl, schwarz / Glas opal-matt, weiss  
luminaire de table; acier, noir / verre opale mat, blanc

H 330, Ø 210

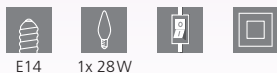

### 900358 BILBANA

table light; steel, black / glass opal-matt, white  
Tischleuchte; Stahl, schwarz / Glas opal-matt, weiss  
luminaire de table; acier, noir / verre opale mat, blanc

L 145, B 135, H 195, Base: B 135, T 115







### 97209 OLIVAL 1

table light; steel, black / smoked glass, black-transparent  
Tischleuchte; Stahl, schwarz / Rauchglas, schwarz-transparent  
luminaire de table; acier, noir / verre fumé, noir transparent

L 200, B 200, H 305



### 900141 SOLO 2

table light; steel, black / glass vaporized, black-transparent  
Tischleuchte; Stahl, schwarz / Glas bedampft, schwarz-transparent  
luminaire de table; acier, noir / verre vaporisé, noir transparent

H 415, Ø 260, Base: Ø 180

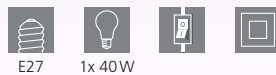

### 900142 SOLO 2

table light; steel, black / glass etched, white  
Tischleuchte; Stahl, schwarz / Glas geätzt, weiss  
luminaire de table; acier, noir / verre gravé, blanc

H 415, Ø 260, Base: Ø 180





**87254**



**87256**



**85104**

### 87254 SOLO 1

table light; steel, brass-matt / satin glass, white  
Tischleuchte; Stahl, messing-matt / Glas satiniert, weiss  
luminaire de table; acier, laiton mat / verre satiné, blanc

H 350, Ø 260, Base: Ø 130



E14 1x 40W



9 002759 872540



### 87256 SOLO 1

table light; steel, wood, bronzed, nut / satin glass, white  
Tischleuchte; Stahl, Holz, brüniert, Nuss / Glas satiniert, weiss  
luminaire de table; acier, bois, brun, noisette / verre satiné, blanc

H 350, Ø 260, Base: Ø 130



E14 1x 40W



9 002759 872564



### 85104 SOLO 1

table light; steel, satin nickel / satin glass, white  
Tischleuchte; Stahl, nickel-matt / Glas satiniert, weiss  
luminaire de table; acier, nickel mat / verre satiné, blanc

H 350, Ø 260, Base: Ø 130

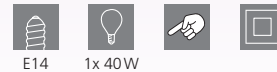

E14 1x 40W



9 002759 851040





91238



95785



95785



82305



82305

### 91238 SOLO

table light; steel, satin nickel / satin glass, white with decor  
Tischleuchte; Stahl, nickel-matt / Glas satiniert, weiss m. Dekor  
luminaire de table; acier, nickel mat / verre satiné, blanc avec décor

H 320, Ø 265, Base: Ø 130

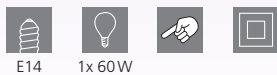

E14 1x 60W



9 002759 912383



### 95785 DAMASCO 1

table light; steel, satin nickel / glass opal-matt, white  
Tischleuchte; Stahl, nickel-matt / Glas opal-matt, weiss  
luminaire de table; acier, nickel mat / verre opale mat, blanc

H 300, Ø 145, Base: Ø 120



E14 1x 60W



9 002759 957858



### 82305 SLIM

table light; steel, satin nickel / glass, white  
Tischleuchte; Stahl, nickel-matt / Glas, weiss  
luminaire de table; acier, nickel mat / verre, blanc

H 220, Ø 70, Base: Ø 100

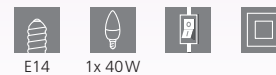

E14 1x 40W



9 002759 823054





95775 | 95776 | 81828



95775



95776



98887

### 95775 DAMASCO 1

table light; steel, satin nickel / satin glass, white  
Tischleuchte; Stahl, nickel-matt / Glas satiniert, weiss  
luminaire de table; acier, nickel mat / verre satiné, blanc

H 215, Ø 100



9 002759 957759



### 95776 DAMASCO 1

table light; steel, chrome / satin glass, white  
Tischleuchte; Stahl, chrom / Glas satiniert, weiss  
luminaire de table; acier, chrome / verre satiné, blanc

H 215, Ø 100



9 002759 957766



### 98887 DAMASCO 1

table light; steel, black / glass vaporized, black-transparent  
Tischleuchte; Stahl, schwarz / Glas bedampft, schwarz-transparent  
luminaire de table; acier, noir / verre vaporisé, noir transparent

H 310, Ø 100



9 002759 988876

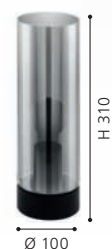





81827 | 91242

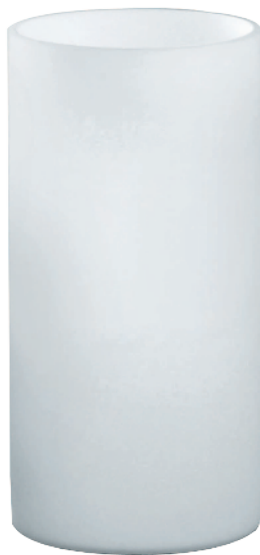

81827



81828



91242

### 81827 GEO

table light; glass, plastic, white  
Tischleuchte; Glas, Kunststoff, weiss  
luminaire de table; verre, plastique, blanc

H 200, Ø 100, Base: Ø 100

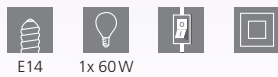

E14 1x 60W



9 002759 818272



### 81828 GEO

table light; glass opal-matt, white  
Tischleuchte; Glas opal-matt, weiss  
luminaire de table; verre opale mat, blanc

H 350, Ø 120, Base: Ø 120

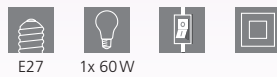

E27 1x 60W



9 002759 818289



### 91242 GEO

table light; glass, plastic, white  
Tischleuchte; Glas, Kunststoff, weiss  
luminaire de table; verre, plastique, blanc

H 200, Ø 100

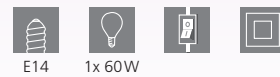

E14 1x 60W



9 002759 912420





99597  
LED



DESIGN  
HIGHLIGHT  
DETAIL



99794



**99597 NARANJO**

table light; steel, black / glass, clear  
Tischleuchte; Stahl, schwarz / Glas, klar  
luminaire de table; acier, noir / verre, transparent

L 450, B 430, H 555



4x 4,1 W 1520lm



**99794 DESIERTO**

table light; steel, wood, black, brown  
Tischleuchte; Stahl, Holz, schwarz, braun  
luminaire de table; acier, bois, noir, marron

H 540, Ø 450, Base: Ø 330



E27 1x 40W



# OFFICE TABLE & FLOOR LUMINAIRES

BÜRO TISCH- & STEHLEUCHTEN

LUMINAIRES DE TABLE & LAMPADAIRES À BUREAU

---

## WE LOVE LIGHT

The range of office table and floor luminaires is made up of many different styles and convinces with its diverse uses.

---

## WIR STEHEN AUF LICHT

Das Sortiment der Büro Tisch- und Stehleuchten setzt sich aus unterschiedlichen Stilen zusammen und überzeugt mit seinen vielseitigen Einsatzmöglichkeiten.



## NOUS NOUS TENONS EN PLEINE LUMIÈRE

La gamme d'éclairages de table et sur pieds à bureau est formée de différents styles et persuade par ses multiples possibilités d'application.

---





# OVERVIEW

## OFFICE TABLE & FLOOR LUMINAIRES



TRUNCA  
p. 802



MASSERIE  
p. 802



ARENAZA  
p. 803



BANDERALO  
p. 804



CASIBARE-QI  
p. 805



LACEY-QI  
p. 805



VERADAL-QI  
p. 805



SELLANO  
p. 806



LA SECA  
p. 807



CAUPO  
p. 808



BROLINI  
p. 809



COGNOLI  
p. 810



LAROA  
p. 812-813



CEPPINO  
p. 814



VERADAL  
p. 814-815



DURENGO  
p. 816



DAMBERA  
p. 816



SNAPORA  
p. 816



GEXO  
p. 818



CABALES  
p. 818-819



CABADO 1  
p. 820



CAJERO  
p. 820-821



TABILLANO 1  
p. 822



TORONA 1  
p. 822



BORGILLO  
p. 824-825



BANKER  
p. 826



FIRMO  
p. 827



BASIC 1  
p. 828



BASIC  
p. 828-829



FOX  
p. 830



This product is available in different colors and shapes./ Dieser Artikel ist in unterschiedlichen Farben und Formen verfügbar.  
Cet article est disponible en différentes couleurs et formes.





## 98093, 98247, 99828, 99829

These luminaires have a Qi charging function. They can wirelessly charge Qi-compatible Smartphones by inductive energy transfer.

Diese Leuchten besitzen eine Qi-Ladefunktion. Damit können Qi-kompatible Smartphones über induktive Energieübertragung kabellos geladen werden.

Ces luminaires disposent d'une fonction de chargement Qi. Cela permet aux smartphones compatibles Qi d'être chargés sans fil par transmission d'énergie inductive.



98093



98247



### 98093 TRUNCA

table light; plastic, white

Tischleuchte; Kunststoff, weiss

luminaire de table; plastique, blanc

H 485, Base: B 185, T 185



4W



450lm



9 002759 980931



### 98247 MASSERIE

table light; plastic, white

Tischleuchte; Kunststoff, weiss

luminaire de table; plastique, blanc

H 385, Base: B 165, T 165



3,4W



460lm



9 002759 982478







99828

LED

Qi Fast  
Charger



99829

LED

Qi Fast  
Charger



DESIGN  
HIGHLIGHT  
DETAIL

### 99828 ARENAZA

table light; steel, plastic, white, black  
Tischleuchte; Stahl, Kunststoff, weiss, schwarz  
luminaire de table; acier, plastique, blanc, noir

L 240, B 130, H 320, Base: B 240, T 120

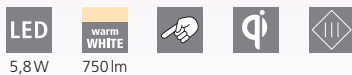

5,8W 750lm



9 002759 998288



### 99829 ARENAZA

table light; steel, plastic, black  
Tischleuchte; Stahl, Kunststoff, schwarz  
luminaire de table; acier, plastique, noir

L 240, B 130, H 320, Base: B 240, T 120

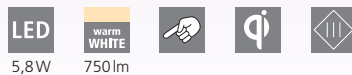

5,8W 750lm



9 002759 998295





99831

LED

Qi Fast  
Charger



99832

LED

Qi Fast  
Charger



DESIGN  
HIGHLIGHT  
DETAIL

### 99831 BANDERALO

table light; plastic, white

Tischleuchte; Kunststoff, weiss

luminaire de table; plastique, blanc

L 305, B 170, H 405, Base: Ø 170



4,8W



700lm



### 99832 BANDERALO

table light; plastic, black

Tischleuchte; Kunststoff, schwarz

luminaire de table; plastique, noir

L 305, B 170, H 405, Base: Ø 170



4,8W



700lm



9 002759 998318



9 002759 998325





900626

LED



900628

LED

### 900626 LACEY-QI

table light; steel, wood, black, brown / steel, black, creme  
 Tischleuchte; Stahl, Holz, schwarz, braun / Stahl, schwarz, creme  
 luminaire de table; acier, bois, noir, marron / acier, noir, crème

L 255, B 135, H 485, Base: B 190, T 130

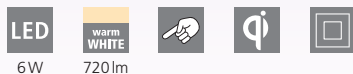

### 900628 VERADAL-QI

table light; wood, plastic, black, brown / steel, black  
 Tischleuchte; Holz, Kunststoff, schwarz, braun / Stahl, schwarz  
 luminaire de table; bois, plastique, noir, marron / acier, noir

B 125, H 490, Base: Ø 160

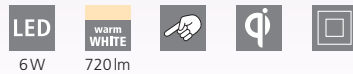



93901

LED

### 93901

The touch buttons can be used to dim the luminaire and adjust the light colour.

Über die Berührungsschalter kann man die Leuchte dimmen und die Lichtfarbe einstellen.

Les boutons tactiles peuvent être utilisés pour dimmer et régler la couleur de la lumière.



### 93901 SELLANO

table light; plastic, steel, white, black  
 Tischleuchte; Kunststoff, Stahl, weiss, schwarz  
 luminaire de table; plastique, acier, blanc, noir

H 430, Base: B 180, T 180

LED

4W

tunable  
 WHITE

450lm



9 002759 939014







97044

LED

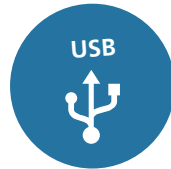

97045

LED



### LA SECA

These luminaires have a USB port for charging and operating the luminaires.

Diese Leuchten verfügen über einen USB-Anschluss, der zum Laden und Betrieb der Leuchten dient.

Faites fonctionner et charger ces luminaires grâce au port USB.

### 97044 LA SECA

table light; plastic, white  
Tischleuchte; Kunststoff, weiss  
luminaire de table; plastique, blanc

L 200, B 50, H 260, Base: B 70, T 50



1,8W



170lm



Li-ion



1200mAh



9 002759 970444

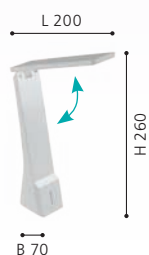

### 97045 LA SECA

table light; plastic, black  
Tischleuchte; Kunststoff, schwarz  
luminaire de table; plastique, noir

L 200, B 50, H 260, Base: B 70, T 50



1,8W



170lm



Li-ion



1200mAh



9 002759 970451



DESIGN  
HIGHLIGHT  
DETAIL



93966

LED



93965

LED

**93966 CAUPO**

table light; plastic, steel, black  
Tischleuchte; Kunststoff, Stahl, schwarz  
luminaire de table; plastique, acier, noir

L 260, H 320, Base: B 150, T 150



2,1W 210lm



9 002759 939663



**93965 CAUPO**

table light; plastic, steel, white  
Tischleuchte; Kunststoff, Stahl, weiss  
luminaire de table; plastique, acier, blanc

L 260, H 320, Base: B 150, T 150



2,1W 210lm



9 002759 939656





900529

LED



900528

LED

**900529 BROLINI**

table light; plastic, white  
Tischleuchte; Kunststoff, weiss  
luminaire de table; plastique, blanc

H 550, Ø 150, Base: Ø 150

LED 2,1W  
 tunable WHITE 300lm  
 touch control  
 ACCU  
 Li-ion 1500mAh



9 008606 242832



**900528 BROLINI**

table light; plastic, black  
Tischleuchte; Kunststoff, schwarz  
luminaire de table; plastique, noir

H 550, Ø 150, Base: Ø 150

LED 2,1W  
 tunable WHITE 300lm  
 touch control  
 ACCU  
 Li-ion 1500mAh



9 008606 242825





DESIGN  
HIGHLIGHT  
DETAIL



97915

LED

### 97915 COGNOLI

table light; plastic, white  
Tischleuchte; Kunststoff, weiss  
luminaire de table; plastique, blanc

L 70, B 100, H 510, Base: B 100, T 70

LED

4,4W

neutral  
WHITE

430lm



9 002759 979157

### 97914 COGNOLI

table light; plastic, black  
Tischleuchte; Kunststoff, schwarz  
luminaire de table; plastique, noir

L 70, B 100, H 510, Base: B 100, T 70

LED

4,4W

neutral  
WHITE

430lm



9 002759 979140





97914

LED



96437

LED



96434

LED



96438

LED

### 96437 LAROA

clamp light; plastic, black  
Klemmleuchte; Kunststoff, schwarz  
luminaire à pince; plastique, noir

L 450, B 65, H 275

LED

3,5W

neutral  
WHITE

400lm



9 002759 964375



### 96434 LAROA

clamp light; plastic, white  
Klemmleuchte; Kunststoff, weiss  
luminaire à pince; plastique, blanc

L 450, B 65, H 275

LED

3,5W

neutral  
WHITE

400lm



9 002759 964344



### 96438 LAROA

table light; plastic, black  
Tischleuchte; Kunststoff, schwarz  
luminaire de table; plastique, noir

L 480, B 120, H 325, Base: B 170, T 120

LED

3,5W

neutral  
WHITE

400lm



9 002759 964382





96435

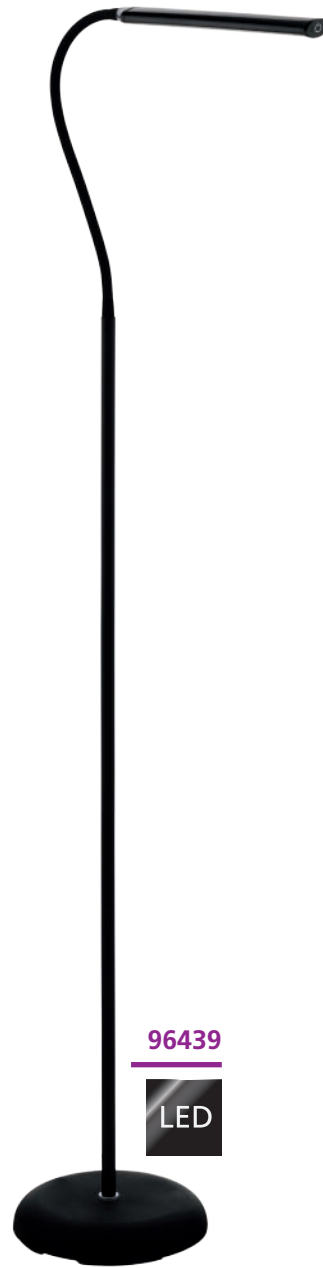

96439

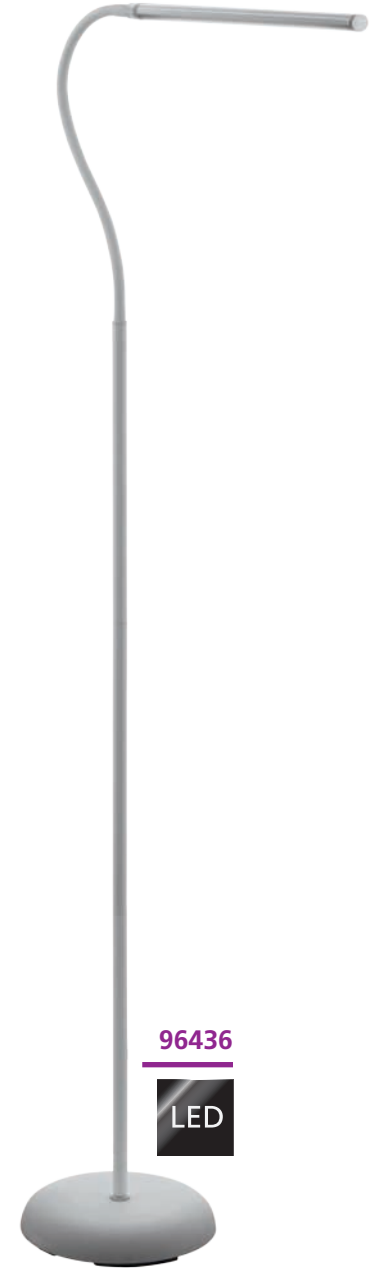

96436



### 96435 LAROA

table light; plastic, white  
Tischleuchte; Kunststoff, weiss  
luminaire de table; plastique, blanc

L 480, B 120, H 325, Base: B 170, T 120



3,5W 400lm



9 002759 964351



### 96439 LAROA

floor light; plastic, black  
Stehleuchte; Kunststoff, schwarz  
lampadaire; plastique, noir

L 535, B 215, H 1300, Base: Ø 210



3,5W 400lm



9 002759 964399

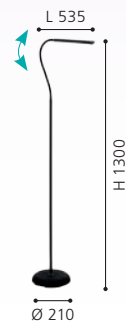

### 96436 LAROA

floor light; plastic, white  
Stehleuchte; Kunststoff, weiss  
lampadaire; plastique, blanc

L 535, B 215, H 1300, Base: Ø 210



3,5W 400lm



9 002759 964368

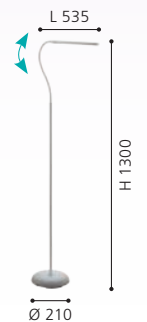

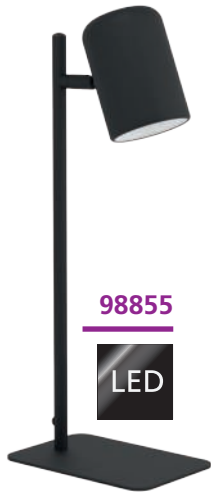

98855

LED

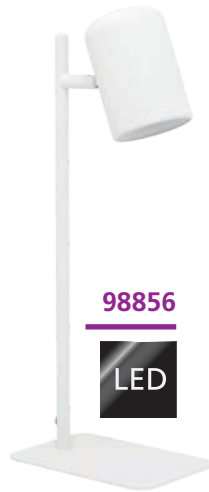

98856

LED



98832



### 98855 CEPPINO

table light; steel, black, white  
Tischleuchte; Stahl, schwarz, weiss  
luminaire de table; acier, noir, blanc

H 380, Base: B 165, T 110



GU10

1x 4,5W

1x  
warm  
WHITE  
345lm

### 98856 CEPPINO

table light; steel, white  
Tischleuchte; Stahl, weiss  
luminaire de table; acier, blanc

H 380, Base: B 165, T 110

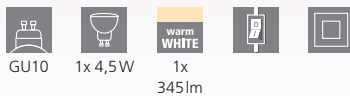

GU10

1x 4,5W

1x  
warm  
WHITE  
345lm

### 98832 VERADAL

table light; wood, plastic, white, brown / steel, white  
Tischleuchte; Holz, Kunststoff, weiss, braun / Stahl, weiss  
luminaire de table; bois, plastique, blanc, marron / acier, blanc

B 125, H 490, Base: Ø 160



E27

1x 40W



9 002759 988555



9 002759 988562



9 002759 988326







98831



## 98831 VERADAL

table light; wood, plastic, black, brown / steel, black  
Tischleuchte; Holz, Kunststoff, schwarz, braun / Stahl, schwarz  
luminaire de table; bois, plastique, noir, marron / acier, noir

B 125, H 490, Base: Ø 160



E27



1x 40W



9 002759 988319





93078

LED



94673

LED

### 93078 DURENGO

table light; plastic, steel, white, chrome  
Tischleuchte; Kunststoff, Stahl, weiss, chrom  
luminaire de table; plastique, acier, blanc, chrome

H 380, Ø 160, Base: Ø 160

LED

warm  
WHITE



2,5W

250lm

### 94673 DAMBERA

table light; plastic, black  
Tischleuchte; Kunststoff, schwarz  
luminaire de table; plastique, noir

H 375, Base: Ø 170

LED

warm  
WHITE



4,5W

660lm

### 94677 SNAPORA

table light; plastic, aluminium, black  
Tischleuchte; Kunststoff, Alu, schwarz  
luminaire de table; plastique, aluminium, noir

H 485, Base: Ø 110

LED

warm  
WHITE



3W

300lm



9 002759 930783



9 002759 946739



9 002759 946777





94677

LED



93076

LED



93077

LED



99334

LED

### 93076 GEXO

table light; plastic, steel, black, chrome  
Tischleuchte; Kunststoff, Stahl, schwarz, chrom  
luminaire de table; plastique, acier, noir, chrome

H 320, Ø 125, Base: Ø 125

LED

2,5W

warm WHITE

230lm



9 002759 930769

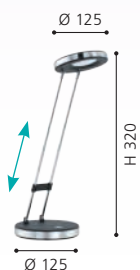

### 93077 GEXO

table light; plastic, steel, white, chrome  
Tischleuchte; Kunststoff, Stahl, weiss, chrom  
luminaire de table; plastique, acier, blanc, chrome

H 320, Ø 125, Base: Ø 125

LED

2,5W

warm WHITE

230lm



9 002759 930776



### 99334 CABALES

table light; plastic, white  
Tischleuchte; Kunststoff, weiss  
luminaire de table; plastique, blanc

H 340, Ø 140, Base: Ø 140

LED

4,6W

warm WHITE

490lm



9 002759 993344







99335

LED

### 99335 CBALES

table light; plastic, black  
Tischleuchte; Kunststoff, schwarz  
luminaire de table; plastique, noir

H 340, Ø 140, Base: Ø 140



4,6W 490lm





97078

This luminaire has a colored light in the base.  
 Diese Leuchte verfügt über ein farbiges Licht im Sockel.  
 Cette luminaire a une lumière colorée dans la base.



97078



95695



**97078 CABADO 1**

table light; plastic, white  
 Tischleuchte; Kunststoff, weiss  
 luminaire de table; plastique, blanc

L 140, B 110, H 490, Base: B 130, T 105

LED 2,4W neutral WHITE 300lm LED 0,3W RGB 20lm



**95695 CAJERO**

table light; plastic, white  
 Tischleuchte; Kunststoff, weiss  
 luminaire de table; plastique, blanc

L 150, B 100, H 500, Base: B 155, T 100

LED 4,5W neutral WHITE 687lm



**95696 CAJERO**

table light; plastic, black  
 Tischleuchte; Kunststoff, schwarz  
 luminaire de table; plastique, noir

L 150, B 100, H 500, Base: B 155, T 100

LED 4,5W neutral WHITE 687lm





95696

LED



95694

LED

### 95694 CAJERO

table light; plastic, silver  
Tischleuchte; Kunststoff, silber  
luminaire de table; plastique, argent

L 150, B 100, H 500, Base: B 155, T 100

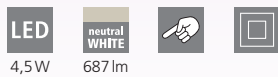

4,5W 687 lm





DESIGN  
HIGHLIGHT  
DETAIL



99019

### 99019 TABILLANO 1

table light; steel, black  
Tischleuchte; Stahl, schwarz  
luminaire de table; acier, noir

L 560, B 180, H 475, Base: Ø 180



E27 1x 40W



9 002759 990190



### 96957 TORONA 1

table light; steel, white / wood, natural  
Tischleuchte; Stahl, weiss / Holz, natur  
luminaire de table; acier, blanc / bois, nature

L 445, B 180, H 605, Base: Ø 180



E14 1x 28W



9 002759 969578







96957



**94699**



**94702**

**94699 BORGILLIO**

table light; steel, white  
Tischleuchte; Stahl, weiss  
luminaire de table; acier, blanc

**94702 BORGILLIO**

table light; steel, chrome  
Tischleuchte; Stahl, chrom  
luminaire de table; acier, chrome

**94697 BORGILLIO**

table light; steel, black  
Tischleuchte; Stahl, schwarz  
luminaire de table; acier, noir

L 400, B 190, H 710, Base: Ø 190



E27 1x 40W



9 002759 946999

L 400, B 190, H 710, Base: Ø 190

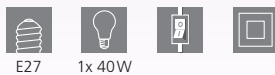

E27 1x 40W



9 002759 947026

L 400, B 190, H 710, Base: Ø 190

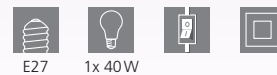

E27 1x 40W



9 002759 946975





94697



94704

### 94704 BORGILLIO

table light; steel, copper  
Tischleuchte; Stahl, kupfer  
luminaire de table; acier, cuivre

L 400, B 190, H 710, Base: Ø 190



E27



1x 40W



9 002759 947040

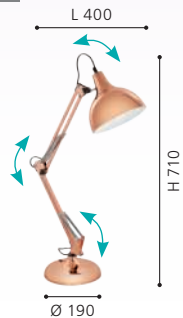



90967



### 90967 BANKER

table light; steel, brass / glass painted, green  
Tischleuchte; Stahl, messing / Glas lackiert, grün  
luminaire de table; acier, laiton / verre laqué, marron granit

L 275, H 390



E27



1x 60W





## FIRMO

These luminaires come with a clip.

Diese Leuchten sind mit einer Klemme ausgestattet.

Ces luminaires viennent avec une pince fixation.



### 90872 FIRMO

table light; steel, plastic, shiny white  
Tischleuchte; Stahl, Kunststoff, weiss glänzend  
luminaire de table; acier, plastique, blanc brillant

L 730



E27 1x 40W



9 002759 908720



### 90873 FIRMO

table light; steel, plastic, shiny black  
Tischleuchte; Stahl, Kunststoff, schwarz glänzend  
luminaire de table; acier, plastique, noir brillant

L 730



E27 1x 40W



9 002759 908737



### 90874 FIRMO

table light; steel, plastic, silver  
Tischleuchte; Stahl, Kunststoff, silber  
luminaire de table; acier, plastique, argent

L 730

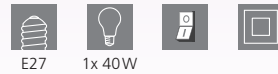

E27 1x 40W



9 002759 908744





90977



9228



9229

### 90977 BASIC 1

table light; plastic, steel, silver  
Tischleuchte; Kunststoff, Stahl, silber  
luminaire de table; plastique, acier, argent

H 300, Base: Ø 125



E27 1x 40W



9 002759 909772



### 9228 BASIC

table light; plastic, steel, black  
Tischleuchte; Kunststoff, Stahl, schwarz  
luminaire de table; plastique, acier, noir

H 300, Base: Ø 125



E27 1x 40W



9 002759 922801



### 9229 BASIC

table light; plastic, steel, white  
Tischleuchte; Kunststoff, Stahl, weiss  
luminaire de table; plastique, acier, blanc

H 300, Base: Ø 125



E27 1x 40W



9 002759 922900





9230

9232

### 9230 BASIC

table light; plastic, steel, red  
 Tischleuchte; Kunststoff, Stahl, rot  
 luminaire de table; plastique, acier, rouge

### 9232 BASIC

table light; plastic, steel, blue  
 Tischleuchte; Kunststoff, Stahl, blau  
 luminaire de table; plastique, acier, bleu

H 300, Base: Ø 125



E27 1x 40W



9 002759 923006



H 300, Base: Ø 125

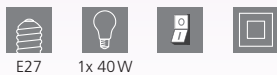

E27 1x 40W



9 002759 923204





DESIGN  
HIGHLIGHT  
DETAIL



92872

LED

### 92872 FOX

table light; steel, white, chrome  
Tischleuchte; Stahl, weiss, chrom  
luminaire de table; acier, blanc, chrome

H 320, Base: Ø 125



GU10 1x 2,8W  
warm  
WHITE  
1x  
250lm



9 002759 928728



Ø 125

### 92873 FOX

table light; steel, anthracite, chrome  
Tischleuchte; Stahl, anthrazit, chrom  
luminaire de table; acier, gris anthracite, chrome

H 320, Base: Ø 125

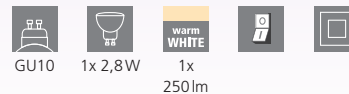

GU10 1x 2,8W  
warm  
WHITE  
1x  
250lm



9 002759 928735



Ø 125





92873

LED

# CHILDREN LUMINAIRES

KINDERLEUCHTEN

LUMINAIRES POUR ENFANTS

## PLAY OF COLOUR

The nursery luminaires are characterised by their playful and child-friendly designs. The lovely motives light up in many different colours and turn the nursery into a very special location.

## FARBENSPIEL

Die Kinderzimmerleuchten zeichnen sich durch ihr verspieltes und kindgerechtes Design aus. Die liebevollen Motive erleuchten in unterschiedlichsten Farben und machen das Kinderzimmer zu einem besonderen Ort.

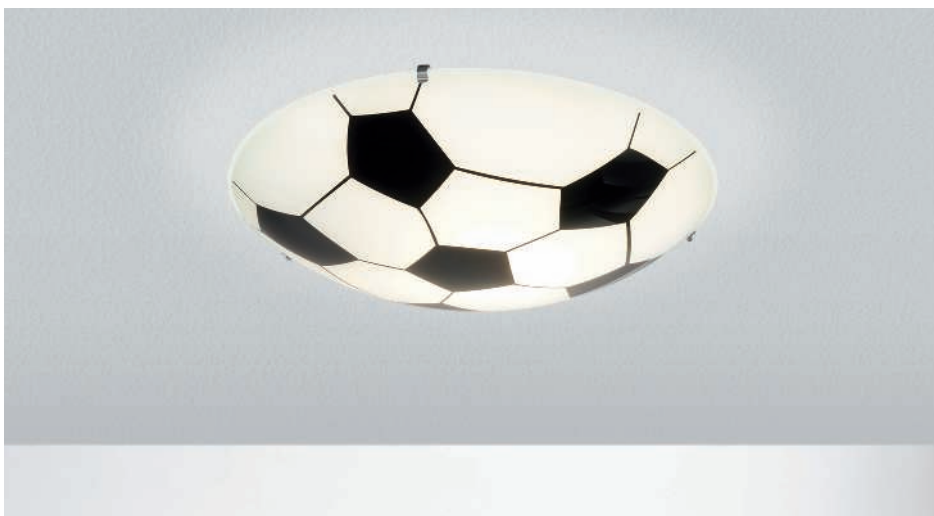

## JEU DE COULEUR

Les éclairages de chambres d'enfants se distinguent de leur design joueur et adapté aux enfants. Les sujets formés avec amour sont illuminés dans des couleurs les plus variées et font de la chambre d'enfant un endroit spécial.









# OVERVIEW

CHILDREN LUMINAIRES



TABARA  
p. 836



JUNIOR 1  
p. 836



RUFFO  
p. 837

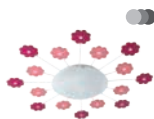

VIKI 1  
p. 837



This product is available in different colors and shapes./ Dieser Artikel ist in unterschiedlichen Farben und Formen verfügbar.  
Cet article est disponible en différentes couleurs et formes.



**97667**



**87284**

### 97667 TABARA

ceiling light; wood, steel, green, white / satin glass, design "soccer"

Deckenleuchte; Holz, Stahl, grün, weiss / Glas satiniert, Motiv Fussball

plafonnier; bois, acier, vert, blanc / verre satiné, motif «football»

H 80, Ø 400



E27



1x 60W

### 87284 JUNIOR 1

wall / ceiling light; steel, white / satin glass, design "soccer"

Wand- / Deckenleuchte; Stahl, weiss / Glas satiniert, Motiv Fussball

applique / plafonnier; acier, blanc / verre satiné, motif «football»

Ø 245



E27



1x 60W



9 002759 976675



Ø 400



9 002759 872847



Ø 245



97575



97575

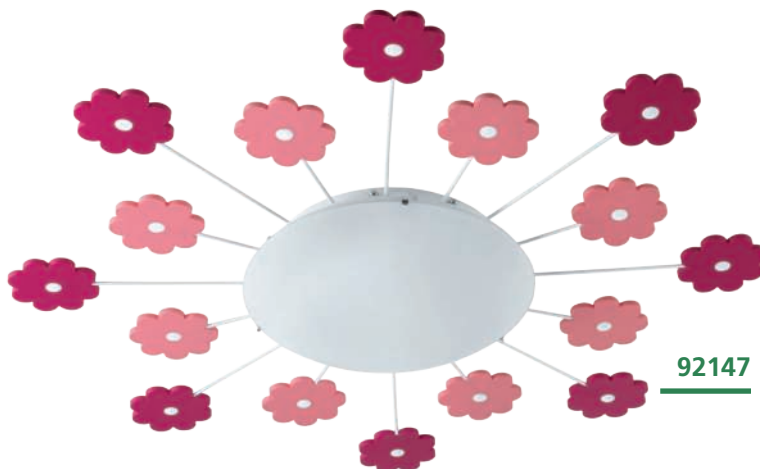

92147



92146

### 97575 RUFFO

ceiling light; steel, white / fabric, coloured  
Deckenleuchte; Stahl, weiss / Textil, bunt  
plafonnier; acier, blanc / tissu, coloré

H 110, Ø 380



E27 2x 40W



9 002759 975753

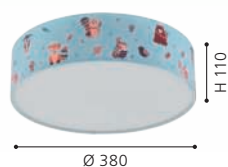

### 92146 VIKI 1

wall / ceiling light; steel, blue / satin glass, white  
Wand- / Deckenleuchte; Stahl, blau / Glas satiniert, weiss  
applique / plafonnier; acier, bleu / verre satiné, blanc

Ø 630, A 80



E27 1x 25W



9 002759 921460

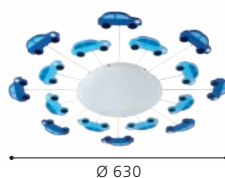

Ø 630

### 92147 VIKI 1

wall / ceiling light; steel, pink / satin glass, white  
Wand- / Deckenleuchte; Stahl, pink / Glas satiniert, weiss  
applique / plafonnier; acier, rose / verre satiné, blanc

Ø 615, A 80



E27 1x 25W



9 002759 921477

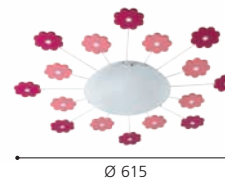

Ø 615

# KITCHEN & FUNCTIONAL LUMINAIRES

KÜCHEN- & FUNKTIONSLEUCHTEN

LUMINAIRES FONCTIONNELS & DE CUISINE

## YOUR KITCHEN FRIEND

Our kitchen and function luminaires ensure the right lighting for your workplace and become true supporters. The practical and perfect fitted luminaires ideally refine your kitchen area.

## IHR KÜCHENFREUND

Unsere Küchen- und Funktionsleuchten sorgen für die richtige Beleuchtung Ihrer Arbeitsfläche und werden zur wahren Alltagshilfe. Die praktischen Unterbauleuchten sind die perfekte Ergänzung für Ihren Küchenbereich.



## VOTRE AMI DE CUISINE

Nos lumières fonctionnelles et de cuisine assurent le bon éclairage de votre surface de travail et deviennent une aide parfaite dans le quotidien. Les éclairages de meuble sont l'accompagnement parfait de votre espace de cuisine.



# OVERVIEW

## KITCHEN & FUNCTIONAL LUMINAIRES



DUNDRY  
p. 840-841



TEYA  
p. 842



KOB LED  
p. 843



BALIOLA  
p. 843



This product is available in different colors and shapes./ Dieser Artikel ist in unterschiedlichen Farben und Formen verfügbar.  
Cet article est disponible en différentes couleurs et formes.



**97572 DUNDRY**

wall / ceiling light; plastic, white / plastic, white  
Wand- / Deckenleuchte; Kunststoff, weiss / Kunststoff, weiss  
applique / plafonnier; plastique, blanc / plastique, blanc

L 570, B 25, H 35



6,6W 850lm

**97573 DUNDRY**

wall / ceiling light; plastic, white / plastic, white  
Wand- / Deckenleuchte; Kunststoff, weiss / Kunststoff, weiss  
applique / plafonnier; plastique, blanc / plastique, blanc

L 870, B 25, H 35



9,3W 1250lm

**97574 DUNDRY**

wall / ceiling light; plastic, white / plastic, white  
Wand- / Deckenleuchte; Kunststoff, weiss / Kunststoff, weiss  
applique / plafonnier; plastique, blanc / plastique, blanc

L 1170, B 25, H 35



12,8W 1700lm



9 002759 975722



9 002759 975739



9 002759 975746

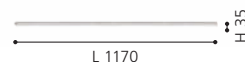





97571

LED

### 97571 DUNDRY

wall / ceiling light; plastic, white / plastic, white  
Wand- / Deckenleuchte; Kunststoff, weiss / Kunststoff, weiss  
applique / plafonnier; plastique, blanc / plastique, blanc

L 310, B 25, H 35

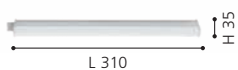





96081



### TEYA

Mounting type: incl. mounting clips  
Switch type: sensor switch (on/off)

Befestigungsart: inkl. Montageclips  
Schalterart: Sensor Schalter (ein/aus)

Type de fixation : clips de montage inclus  
Type de interrupteur : interrupteur capteur (on/off)

### 96081 TEYA

under cabinet light; aluminium, silver / plastic, white  
Unterbauleuchte; Alu, silber / Kunststoff, weiss  
éclairage de meuble; aluminium, argent / plastique, blanc

L 600, B 55, H 25

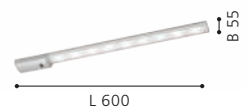





93707

LED

93706

LED

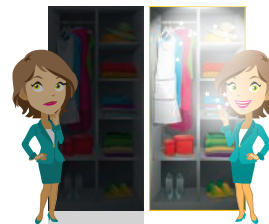

94686

LED



3 m

94686

Incl. battery: yes  
 Inkl. sensor: yes  
 Switch type: on/off/auto  
 Mounting type: incl. adhesive tape  
 Moveable LED: no

Inkl. Batterie: ja  
 Inkl. Sensor: ja  
 Schalterart: ein/aus/auto  
 Befestigungsart: inkl. Klebeband  
 Bewegliche LED: nein

Piles incluses : oui  
 Capteur inclus : oui  
 Type de interrupteur : marche/arrêt/auto  
 Type de fixation : ruban adhésif inclus  
 LED réglable : non



**93707 KOB LED**

under cabinet light; steel, satin nickel  
 Unterbauleuchte; Stahl, nickel-matt  
 éclairage de meuble; acier, nickel mat

L 600, B 70, H 25



3x 2,3W 780lm



9 002759 937072

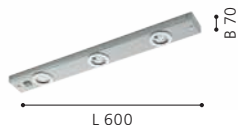

**93706 KOB LED**

under cabinet light; steel, white  
 Unterbauleuchte; Stahl, weiss  
 éclairage de meuble; acier, blanc

L 600, B 70, H 25



3x 2,3W 780lm



9 002759 937065



**94686 BALIOLA**

wall light; plastic, silver  
 Wandleuchte; Kunststoff, silber  
 applique; plastique, argent

L 180, H 46, A 27

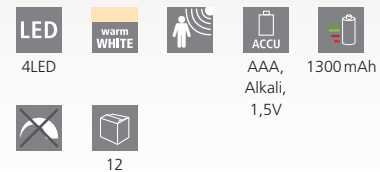

4LED  
 ACCU  
 AAA, Alkali, 1,5V  
 1300mAh



12



9 002759 946869

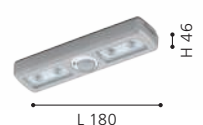

# ACCESSORIES

ZUBEHÖR  
ACCESSOIRES

---

## MAKING IT SPECIAL

Supplement your personal luminaire range with practical accessories and make your everyday life easier.

---

## DAS GEWISSE EXTRA

Ergänzen Sie Ihr persönliches Leuchten-sortiment mit praktischem Zubehör und erleichtern Sie sich somit Ihren Alltag.



## LE PETIT PLUS QUI COMPTE

Accompagnez votre collection personnelle de lumières par des accessoires pratiques et facilitez-vous ainsi votre quotidien.

---



**92288**

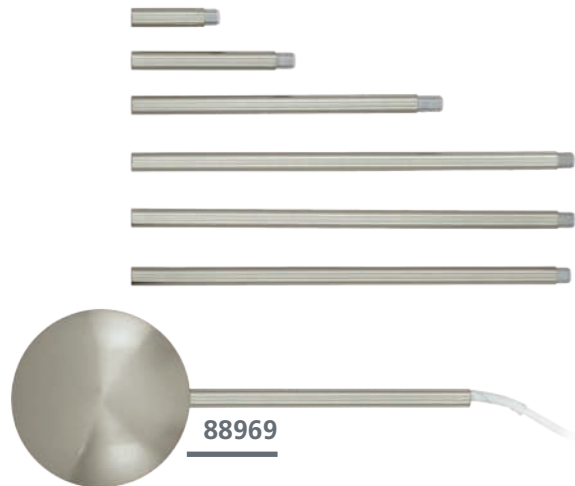

**88969**

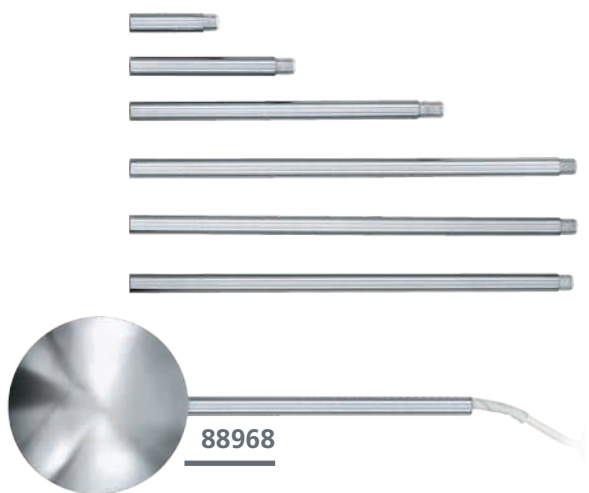

**88968**



**88968, 88969, 92288**

Can be extended or shortened from 320 to 1570 mm by screwing in/off the single pieces.

Der Kabelkanal kann durch Ein-/Ausdrehen der Einzelstücke von 320 bis 1570 mm verlängert bzw. verkürzt werden.

Le conduit de câble peut être prolongé ou raccourci en visse/dévisse les pièces uniques de 320 à 1570 mm.

### 92288 EXTENTION

accessory; steel, white  
Zubehör; Stahl, weiss  
accessoire; acier, blanc

L 1570, B 120

### 88969 EXTENTION

accessory; steel, satin nickel  
Zubehör; Stahl, nickel-matt  
accessoire; acier, nickel mat

L 1570, B 120

### 88968 EXTENTION

accessory; steel, chrome  
Zubehör; Stahl, chrom  
accessoire; acier, chrome

L 1570, B 120

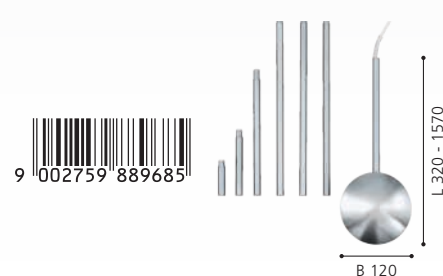
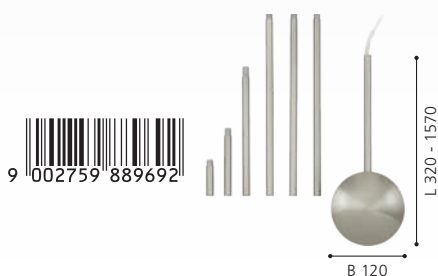



+



=



## RUEDA

Turns your single-light luminaire into a three-light one for brighter lighting!

Verwandelt Ihre einflammige Leuchte in eine dreiflammige Lichtquelle für hellere Beleuchtung!

Il transforme votre luminaire à une lumière en une source lumineuse à trois lumières pour un éclairage plus clair!

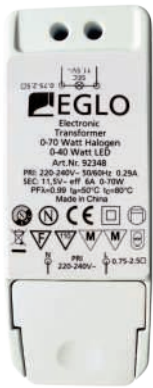

92348



98277



98279

### 92348

accessory; plastic, white  
Zubehör; Kunststoff, weiss  
accessoire; plastique, blanc

L 113, B 44, H 28



10



9 002759 923488



B 44

### 98277 RUEDA

accessory; plastic, white  
Zubehör; Kunststoff, weiss  
accessoire; plastique, blanc

H 75, Ø 190



E27

3x 20W



9 002759 982775



Ø 190

### 98279 RUEDA

accessory; plastic, black  
Zubehör; Kunststoff, schwarz  
accessoire; plastique, noir

H 75, Ø 190



E27

3x 20W



9 002759 982799



Ø 190





1



2

98277



3

# GLASS ASSORTMENT

GLAS SORTIMENT  
SORTIMENT DE VERRES

## SPECIAL GLASS

on this page we would like to give you a detailed view on an assortment of glasses that are used with our luminaires.

## SPEZIAL GLAS

Auf diesen Seiten möchten wir Ihnen einen detaillierten Blick auf ausgesuchte Gläser geben, welche wir für unsere Produkte verwenden.



## VERRES SPECIAL

Sur cette page nous voulons vous donner un aperçu détaillé des verres choisis que nous utilisons pour notre produits.



# GLASS MATERIALS

GLAS-MATERIALIEN  
MATÉRIAUX DE VERRE



glass alabaster, white  
Glas alabaster, weiß  
verre albâtre, blanc

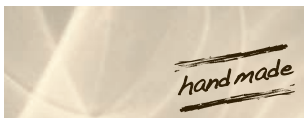

glass alabaster, champagne  
Glas alabaster, champagner  
verre albâtre, champagne

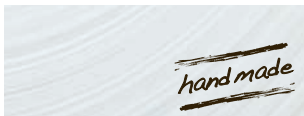

coating, black  
Beschichtung, schwarz  
revêtement, noir



glass wipe technique, champagner  
Glas Wischtechnik, champagner  
verre technique à l'essuyés, champagner



limed glass  
Glas gekalkt  
verre chaulé



brilliant glass  
Brillantglas  
verre brillant

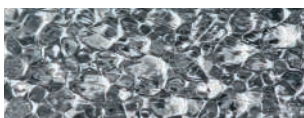

structured glass  
Glas mit Struktur  
verre structuré blanc



molten splinters of glass/ brilliant glass (granille)  
geschmolzene Splitter von Glas / Brillantglas (granille)  
éclats fondus de verre / verre brillant (granille)

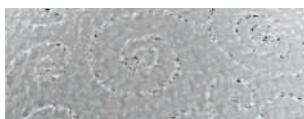

structured glass, white printed decor  
strukturiertes Glas, weiß gedrucktes Dekor  
verre structuré, décor imprimé blanc



printed glass with decor  
bedrucktes Glas mit Dekor  
verre imprimé avec la décoration



glass painted, green  
Glas lackiert, grün  
verre laqué, vert



smoked glass, black-transparent  
Rauchglas, schwarz-transparent  
verre fumé, noir transparent



glass vaporized, black-transparent  
Glas bedampft, schwarz-transparent  
verre vaporisé, noir transparent



glass vaporized, amber  
Glas bedampft, amber  
verre vaporisé, ambre



gold-color  
goldfarben  
or



black-brown-transparent  
schwarz-braun-transparent  
noir-marron-transparent



black-grey-transparent  
schwarz-grau-transparent  
noir-gris-transparent

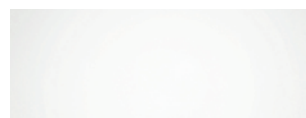

glass opal-matt  
glas opal-matt  
verre opale-mat

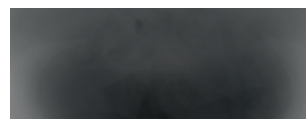

grey-matt  
grau-matt  
gris mat



# EGLO WORLDWIDE

EGLO WELTWEIT

EGLO DANS LE MONDE



**AUSTRIA**  
EGLO LEUCHTEN GMBH

Heiligkreuz 22  
6136 Pill  
T: +43 5242 6996 0 | F: +43 5242 6996 972  
info-austria@eglo.com



**AUSTRALIA**  
EGLO LIGHTING AUSTRALIA

5/339 Archerfield Road  
4077 Richlands | Queensland  
T: +61 7 3375 1413 | F: +61 7 3375 1412  
info@eglolighting.com.au



**BELGIUM**  
EGLO BELGIUM BV

Antwerpsesteenweg 247  
2950 Kapellen  
T: +32 3 250 60 80 | F: +32 3 219 80 67  
info-belgium@eglo.com



**BOSNIA AND HERZEGOVINA**  
EGLO RASVJETA BH D.O.O.

Ormanica bb  
76250 Gradacac  
T: +387 35 86 85 00 | F: +387 35 82 44 41  
info-Bosnia-Herzegovina@eglo.com



**BULGARIA**  
EGLO BULGARIA EOOD

Main Road Burgas-Sofia | 5th kilometer | Building EGLO  
8000 Burgas  
T: +359 56 960 403 | F: +359 56 53 05 95  
info-bulgaria@eglo.com



**CANADA**  
EGLO CANADA INC.

20700 Route Transcanadienne  
H9X 4B7 Baie D'Ufré, Quebec  
T: +1 514 457 5483 | F: +1 514 457 5487  
info-canada@eglo.com



**CHILE**  
EGLO CHILE ILUMINACIÓN LTDA.

Av. Américo Vespucio Norte 1930  
Conchali - Santiago de Chile  
T: +562 2 595 2222  
info-chile@eglo.com



**CHINA**  
DONGGUAN EGLO LIGHTING COMMERCIAL  
CO LTD

No.1 | Shangqiao Industrial Rd Shangqiao, Dongcheng  
Dongguancity, Guanzhouprovince  
T: +86 769 2203 3866 | F: +86 769 2203 6866  
info-china@eglo.com



**COLOMBIA**  
EGLO COLOMBIA ILUMINACIÓN SAS

Autopista Norte 800 Mts adelante del Peaje de los Andes  
Costado Oriental Km 19 Lote 30  
Bogotá - Chia  
T: +57 (1) 744 2339  
info-global@eglo.com



**COSTA RICA**  
EGLO COSTA RICA

Centro Comercial Calle Real local #8  
Guachipilin de Escazú de la sucursal del BAC  
San Jose 800 metros al norte | San Jose  
T: +506-2289-4690 | F: +506-2100-6384  
info-costarica@eglo.com



**CROATIA**  
EGLO RASVJETA D.O.O.

Jadranska avenija 9a  
10000 Zagreb  
T: +385 1 379 40 62 | F: +385 1 379 41 04  
info-croatia@eglo.com



**CZECH REPUBLIC**  
EGLO CZ+SK s.r.o.

Náchodská 2479/63  
193 00 Praha 9 Horní Pocernice  
T: +420 281 924 163 | F: +420 281 925 205  
info-czechrepublic@eglo.com



**DENMARK**  
EGLO DANMARK A/S

Agerbakken 20  
8362 Hørning  
T: +45 70 22 55 11 | F: +45 70 22 55 221  
info-denmark@eglo.com



**ESTONIA**  
MOODNE VALGUSTUS AS

Rävalapst. 7  
10143 Tallinn  
T: +372 667 6670 | F: +372 631 3195  
info-global@eglo.com



**FINLAND**  
EGLO FINLAND OY

Malmniraitti 17A  
700 Helsinki  
T: +358 20 7649 820 | F: +358 20 7649 821  
info-finland@eglo.com



**FRANCE**  
EGLO FRANCE LUMINAIRE SARL

Z.A. Jeune Bois | 2 Rue de la Martinique  
68274 Wittenheim  
T: +33 3 89 62 50 45 | F: +33 389 6250 49  
info-france@eglo.com



**GERMANY**  
EGLO LEUCHTEN HANDELS GMBH

Kleinbahnstr. 35  
59759 Arnsberg  
T: +49 2932 6269 0 | F: +49 2932 6269 39  
info-germany@eglo.com



**GREAT BRITAIN AND IRELAND**  
EGLO UK LTD.

Unit 12 Cirrus Park, Lower Farm Road, Moulton Park  
Industrial Estate, Northampton NN3 6UR  
T: +44 1604 790 986 | F: +44 1604 670 282  
info-greatbritain@eglo.com





**GREECE**  
EGLO HELLAS A.E.

Sykias 2 and parodos dekeleias  
13679 Acharnai  
T: +30 21 0800 2363 | F: +30 210 240 07 29  
info-greece@eglo.com



**HUNGARY - PRODUCTION AND LOGISTICS**  
EGLO MAGYARORSZAG KFT.

Fő út, 155  
3060 Paszto  
T: + 36 32 560 050 | F: +36 32 560 040  
info-hungary@eglo.com



**INDIA**  
EGLO INDIA PRIVATE LIMITED

A-307, Ansal Chambers - 1, 3, Bhikaji Cama Place,  
110066 Delhi  
T: +91 85279 44288  
info-india@eglo.com



**ITALY**  
EGLO ITALIANA S.R.L.

Via Giotto, 4  
31021 Mogliano Veneto (TV)  
T: +39 041 45 66 232 / -245/ -251 |  
F: +39 041 45 74 066 / -071  
info-italy@eglo.com



**KAZAKHSTAN**  
EGLO KAZAKHSTAN LLP

Al-Farabi Avenue 7, Office 72, 14rd floor, Block 4A,  
Nurly-Tau Business Center  
50059 Almaty  
T: +7 727 293 25 20 | M: +7 701 031 00 00  
info-kazakhstan@eglo.com



**KOSOVO**  
EGLO KOSOVA LLC

Lugisht e qytetit pn  
20000 Prizren  
T: +383 44 216 687 | SHOP: +383 49 699 100  
info-kosovo@eglo.com



**LATVIA**  
MOODNE VALGUSTUS AS

Rävalapst.7  
10143 Tallinn  
T: +370 652 49923 | T: +372 667 6670  
info-latvia@eglo.com



**LITHUANIA**  
MOODNE VALGUSTUS AS

Rävalapst.7  
10143 Tallinn  
T: +370 652 49923 | T: +372 667 6671  
info-latvia@eglo.com



**MAGYARORSZÁG – ÉRTÉKESÍTÉS**  
EGLO LUX KFT.

Fő út, 143/A  
2120 Dunakeszi  
T: +36 27 341 353 | F: +36 27 341 409  
info-hungary@eglo.com



**MALAYSIA**  
EGLO ASIA SDN BHD

No. 13, Jalan Pelukis U1/46B, Temasya 18, Glenmarie,  
40150 Shah Alam, Selangor Darul Ehsan  
T: +6011 1050 2336 | F: +603 5567 9415  
info-malaysia@eglo.com



**MEXICO**  
EGLO MÉXICO ILUMINACIÓN S DE RL DE CV

Prolongación Avenida López Mateos Sur N°3561,  
Fraccionamiento Los Gavilanes  
C.P. 45645 Tlajomulco de Zúñiga | Jalisco  
T: +52 33 3687 20 95  
info-mexico@eglo.com



**MIDDLE EAST**  
EGLO LIGHTING MIDDLE EAST FZE

P.O. BOX 262073, LOB6, OFFICE G18  
Jebel Ali, Dubai, UAE  
T: +97 148810080 | F: +97 148810081  
gulf@eglo.com



**MOROCCO - EGLO AFRICA**  
EGLO MAGHREB LUMINAIRES SARL

219 Bd Med Zerktonni. Suite: 67  
20330 Casablanca  
T: +212 522 98 80 25 / -05  
info-global@eglo.com | info.africa@eglo.com



**THE NETHERLANDS**  
EGLO VERLICHTING NEDERLAND B.V.

Innovatiepark 20  
4906 AA Oosterhout (NBR)  
T: +31 162 48 28 30  
info.netherlands@eglo.com



**NORWAY**  
MS Belysning AS

Heiaveien 4  
1900 Fetsund  
T: +47 63 888500 | F: +47 63 888501  
info-norway@eglo.com



**PERU**  
EGLO PERU S.A.C

Av Primavera 1419  
Distrito de Santiago de Surco y Departamento de Lima  
T: +51 902 763 635  
info-peru@eglo.com



**POLAND**  
EGLO POLSKA SP. Z O.O.

Ul. Dźwiękowa 2  
02-857 Warszawa  
T: +48 22 644 57 55 | F: +48 22 644 89 82  
info-poland@eglo.com



**PORTUGAL**  
EGLO PORTUGAL ILUMINAÇÃO, LDA

Rua Fonte Parada, 125  
4595-434 Serroa-Paços de Ferreira  
T: +351 255 890 000 | F: +351 255 892 346  
info-portugal@eglo.com



**ROMANIA**  
EGLO ROMANIA PRODEXIM SRL.

Str. Atomistilor nr. 1D  
77125 Magurele - Ilfov  
T: +40 314 250 902 | F: +40 314 250 899  
info-romania@eglo.com



**RUSSIA**  
EGLO LIGHTING LLC

Varshavskoe shosse 3 | Office 23  
117105 Moscow  
T: +7495 789 4311 | F: +7495 789 4312  
info-russia@eglo.com



**SERBIA**  
EGLO RASVETA DOO

Stefana Prvovenčanog 28  
11000 Beograd  
T: +381 11 3981 366 | F: +381 11 3981 389  
info-serbia@eglo.com



**SLOVAKIA**  
EGLO CZ+SK s.r.o

Náchodská 2479/63  
193 00 Praha 9 Horní Pocernice  
T: +421 313 211 551 | F: +421 313 211 556  
info-slovakia@eglo.com



**SLOVENIA**  
EGLO RASVJETA D.O.O.

Jadranska avenija 9a  
10000 Zagreb  
T: +386 158 093 18  
info-slovenia@eglo.com



**SPAIN**  
EGLO ESPANA ILUMINACION S.L.

Avda. de Castilla 1 (Edf. Best Point) 2º -16A  
28830 San Fernando de Henares, Madrid  
T: +34 91 677 9044 | F: +34 91 677 0304  
info-spain@eglo.com



**SWEDEN**  
EGLO SVERIGE AB

Star Street 1  
512 50 Svenljunga  
T: +46 340 623 505 | F: +46 340 623 605  
info-sweden@eglo.com



**SWITZERLAND**  
EGLO SCHWEIZ AG

Seetalstraße 142  
6032 Emmen  
T: +41 41 268 69 59 | F: +41 41 268 69 58  
info-switzerland@eglo.com



**TURKEY**  
EGLO Aydınlatma ithalat ihracat Ltd. Şti.

Eyüp Sultan Mah. Sekmen Cad. No:18/2  
34855 Sancaktepe / Istanbul Samandıra  
T: +90 216 311 09 -02 / -03 / -04 |  
F: +90 216 311 09 / -05  
info-turkey@eglo.com



**UKRAINE**  
EGLO UKRAINE LTD

Vatslava Gavela boulevard, 6/7-A,  
03124 Kyiv  
T: +38 044 463 98 41 | F: +38 044 468 84 67  
info-ukraina@eglo.com



**USA**  
EGLO USA, INC.

3640 Royal South Parkway  
30349 Atlanta, Georgia  
T: +1 404 477 5601 | F: +1 404 393 7053  
info-usa@eglo.com

# HOW TO READ

## ERKLÄRUNG

## COMMENT LIRE

BUTTONS  
BUTTONS  
BOUTONS

Forest Stewardship Council®



p.8-9

### DIMENSIONS DIMENSIONEN DIMENSIONS

all dimensions in mm | alle Größen in mm | toutes dimensions en mm

L = length | Länge | longueur

B = width | Breite | largeur

H = height | Höhe | hauteur

Ø = diameter | Durchmesser | diamètre

A = projection length | Ausladung | amplitude

ET = installation depth | Einbautiefe | profondeur utile

Base = base dimensions | Sockelmaße | dimensions de base

Attention! The dimensions relate solely to the sizes of the luminaire.  
Any air spaces that would be relevant for a safe operating of the lamp were not considered.

Achtung! Die Größen beziehen sich nur auf die Abmessungen der Leuchte. Etwaige Lufträume, die für einen sicheren Betrieb der Leuchte notwendig sind, werden nicht berücksichtigt.

Attention! Les dimensions se réfèrent à la taille de la lampe seulement. Espacements éventuels, que seraient importants pour une opération de la lampe sans danger, n'ont pas été considérés.

### BUTTONS BUTTONS BOUTONS

Colour Rendering Index | Farbwiedergabeindex | Indice de rendu de couleur de LED

**CRI**  
**>90**

p.557

Bulb included | Leuchtmittel inkludiert | ampoules inclus



Recessed Luminaire | Einbauleuchte | luminaire encastrable



Surface Luminaire | Aufbauleuchte | luminaire en saillie



### SKETCHES SKIZZEN CROQUIS

The sketches state the most meaningful dimensions. If a product is adjustable by will, a turquoise arrow marks this function and only the maximum dimensions are indicated.

Die Bemaßung der Skizzen umfasst jeweils die aussagekräftigsten Größen. Bei verstellbaren Produkten kennzeichnet ein türkiser Pfeil diese Funktion und nur die maximalen Größen werden angegeben.

Les dimensions des croquis comprennent les plus représentatives. Si un produit est réglable au choix, une flèche turquoise affiche cette fonction et rien que les dimensions maximales sont indiquées.

**99551 CASIBARE**  
pendant light; steel, black  
Hängeleuchte; Stahl, schwarz  
luminaire en suspension; acier, noir

H 1100, Ø 150

E27 1x 40W

9 002759 995515

Ø 150

**99552 CASIBARE**  
pendant light; steel, black  
Hängeleuchte; Stahl, schwarz  
luminaire en suspension; acier, noir

L 850, B 150, H 1100

E27 3x 40W

9 002759 995522

L 850

**99553 CASIBARE**  
pendant light; steel, black  
Hängeleuchte; Stahl, schwarz  
luminaire en suspension; acier, noir

H 1500, Ø 710

E27 5x 40W

9 002759 995539

Ø 710

LIGHTING FAMILIES / STANDARD  
**234**

ARTICLE NUMBER  
ARTIKELNUMMER  
NUMÉRO D'ARTICLE

SERIES NAME  
SERIENNAME  
NOM DE LA SÉRIE

DESCRIPTION  
BESCHREIBUNG  
DESCRIPTION

The product description is composed as follows:  
luminaire type; enclosure material, enclosure colour / glass or shade material, glass or shade colour  
Die Produktbeschreibung setzt sich wie folgt zusammen:  
Leuchtenart; Gehäusematerial, Gehäusefarbe / Schirm- bzw. Glasmaterial, Schirm- bzw. Glasfarbe  
La description du produit est composée comme suit:  
type de luminaire; matériel de boîtier, couleur de boîtier / matériel de verre ou abat-jour, couleur de verre ou abat-jour



99554



99555

**99554 CASIBARE**  
table light; steel, black  
Tischleuchte; Stahl, schwarz  
luminaire de table; acier, noir

L 160, B 120, H 490, Base: Ø 155



**99555 CASIBARE**  
floor light; steel, black  
Stehleuchte; Stahl, schwarz  
lampadaire; acier, noir

L 350, B 120, H 1605, Base: Ø 250



LIGHTING FAMILIES / STANDARD  
235

PRODUCT / PRODUCT IN THE AMBIANCE  
PRODUKT / PRODUKTE IM AMBIENTE  
PRODUITS / PRODUITS DANS L'AMBIANCE

You can find the article number next to each product on the page and in the ambiance pictures.  
Sie finden die Artikelnummer jedes Produktes neben der Abbildung auf der Seite und auf unseren Ambientebildern.  
Vous pouvez trouver le numéro d'article à la page et à côté de chaque produit dans les images de l'ambiance.

PICTOGRAMMES  
PIKTOGRAMME  
PICTOGRAMMES

Technical details are represented as pictograms. An overview over all pictograms can be found on the next pages.  
Technische Details werden als Piktogramme dargestellt. Eine Übersicht über alle Piktogramme finden Sie auf den nächsten Seiten.  
Les détails techniques sont représentés sous forme de pictogrammes. Vous trouverez un aperçu de tous les pictogrammes dans les pages suivantes.

ENERGY EFFICIENCY LABELS  
ENERGIEEFFIZIENZ-LABEL  
LABEL DE L'EFFICACITÉ ÉNERGÉTIQUE

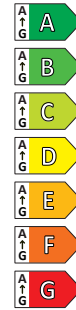
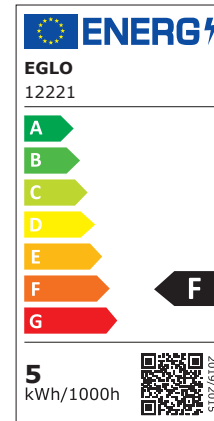

The new energy label must be indicated on all light sources with a luminous flux between 60 and 82,000 lumens and OLED. This applies to lamps, LED modules and luminaires where the light source cannot be removed without destroying it.

Das neue Energielabel muss auf allen Lichtquellen mit einem Lichtstrom zwischen 60 und 82.000 Lumen und OLED angegeben werden. Dies gilt für Lampen, LED-Module und Leuchten, bei denen die Lichtquelle nicht zerstörungsfrei entnommen werden kann.

Le nouveau label énergétique doit être indiqué sur toutes les sources lumineuses dont le flux lumineux est compris entre 60 et 82 000 lumens et sur les OLED. Cela s'applique aux lampes, aux modules LED et aux luminaires dont la source lumineuse ne peut être retirée sans être détruite.



















The information on the label includes: / Die Angaben auf dem Etikett beinhalten: / Les informations figurant sur l'étiquette sont les suivantes :

- › Name/Trademark  
Name/Warenzeichen  
Nom/marque de commerce
- › Model / Modell / Modèle
- › Energy label scale A-G / Energielabel-Skala A-G /  
Échelle d'étiquetage énergétique A-G
- › Energy consumption for 1,000 hours of use/  
Energieverbrauch bei 1.000 Stunden Nutzung/  
Consommation d'énergie pour 1 000 heures  
d'utilisation
- › Energy efficiency class of the product/  
Energieeffizienzklasse des Produkts/  
Classe d'efficacité énergétique du produit
- › QR Code to EPREL (Product Database of the European  
Product Registry for Energylabelling)/  
QR Code zur EPREL (Produktdatenbank der European  
Product Registry for Energylabelling)/  
Code QR pour EPREL (base de données des produits  
du registre européen des produits pour l'étiquetage  
énergétique)
- › The energy spectrum ranges from G to A.  
Das Energiespektrum reicht von G bis A.  
Le spectre énergétique va de G à A.

















































# PICTOGRAM

## PIKTOGRAMME PICTOGRAMME

### SOCKETS / FASSUNGEN / DOUILLES

 LED	 G4	 G53
 2G7	 G5	 GU5,3 / MR16
 2G11	 G9	 GU10
 2GX13	 G10Q	 GX53
 E14	 G13	 GY6,35
 E27	 G23	 R7s

### BULBS / LEUCHTMITTEL / AMPOULES

 E14 / C35	 E27 / A60 Halogen	 E27 / E140 Filament
 E14 / C35f	 E27 / R63 Halogen	 E27 / PS160 Filament
 E14 / D45	 E27 / A60 LED	 E27 / T30 Filament
 E14 / C35f LED	 E27 / A60 Filament	 E27 / T32 Filament
 E14 / D45 Halogen	 E27 / A65 LED	 G4 / T9
 E14 / C35 Halogen	 E27 / A75 Filament	 G4 / LT9
 E14 / T22	 E27 / G45 LED	 G4 / LT14
 E14 / C35 Filament	 E27 / G45 Filament	 G9
 E14 / C37 Filament	 E27 / G80 Filament	 G9 LED
 E14 / C35f Filament	 E27 / G95	 GU10
 E14 / C37f Filament	 E27 / G95 Filament	 GU10 LED
 E14 / P45 LED	 E27 / G125	 GU10 SMD LED
 E14 / P45 Filament	 E27 / G95 LED	 GX53 / LF75
 E14 / P50	 E27 / G200 Filament	<b>LED</b> LED board / LED Platine / LED bord
 E14 / ST48 Filament	 E27 / R63 LED	 MR16
 E14 / ST64 Filament	 E27 / ST48 Filament	 MR16 LED
 E14 / T20 LED	 E27 / ST64 Filament	 R7s / 78mm
 E27 / A60	 E27 / B80 Filament	 R7s / 118mm
 E27 / G90	 E27 / BR150 Filament	 R7s / 78mm LED
 E27 / QR63	 E27 / DP165 Filament	 R7s / 118mm LED



## LIGHT COLOUR & LUMEN / LICHTFARBE & LUMEN / COULEUR LUMINEUX & LUMEN

The colours of the LED are represented as pictogrammes (see below), their luminous flux directly beneath. The luminous flux is quoted in lumen and describes the amount of light generated by the LED. The higher the value, the brighter is the lamp. Lumens are LED boards and are the light measurement value in bulbs.

Die Farben der LED werden als Piktogramm (siehe unten) dargestellt, deren Lichtstrom direkt darunter. Der Lichtstrom wird in Lumen gemessen und gibt die erzeugte Lichtmenge der LED an. Je höher der Wert, desto heller das Produkt. Lichtstromangaben (Lumen) sind Platinen- bzw. Leuchtmittelwerte.

Les couleurs de LED ont représentés sous forme de pictogrammes, leur flux lumineux directement en dessous. L'unité de flux lumineux est le lumen et il mesure la quantité de lumière générée par les LED. Plus la valeur est élevée, plus la lampe est lumineuse. Les lumens sont l'unité de mesure de l'intensité lumineuse des ampoules et des panneaux led intégrés.

	RGB RGB RGB
	RGB + white RGB + weiß RGB + blanc
	RGB + warmwhite RGB + warmweiß RGB + blanc chaud
	RGB + coldwhite RGB + kaltweiß RGB + blanc froid

	RGB + neutralwhite RGB + neutralweiß RGB + blanc neutral
	RGB + tunable white RGB + tunable white RGB + tunable white
	tunable white tunable white tunable white
	warm white warmweiß blanc chaud

	cold white kaltweiß blanc froid
	neutral white neutralweiß blanc neutre

## SWITCHES & SENSORES / SCHALTER & SENSOREN / INTERRUPTEUR & CAPTEURS

	incl. cable & plug inkl. Kabel & Stecker câble & connecteur inclus
	internal dimmer eingebauter Dimmer variateur intégré
	button switch Druckknopf interrupteur de pression
	function switch Funktionsschalter interrupteur fonction
	rocker switch Wippschalter interrupteur à bascule
	pedal dimmer Trittdimmer variateur à pied

	pedal switch Trittschalter interrupteur à pied
	cable switch Kabelschalter interrupteur à câble
	incl. cable & plug transformer inkl. Kabel & Stecktransformator câble & transformateur à prise
	remote control Fernbedienung télécommande
	Day & Night Sensor Tag & Nacht Sensor sensor jour & nuit
	sensor Sensor sensor

	swedish plug Stecker Schweden connecteur swede
	"Touch me" ON/OFF "Touch me" EIN/AUS "Touch me" ON/OFF
	"Touch me" ON/OFF & dimm "Touch me" EIN/AUS & Dimmen "Touch me" ON/OFF & graduable
	pull switch Zugschalter interrupteur à bascule
	Timer - automatic on/off Zeitschaltuhr - automatisches Ein- & Ausschalten minuterie - peut être éteint et allumé automatiquement

## FUNKTIONS & COMFORT / FUNKTIONEN & KOMFORT / FONCTIONS & CONFORT

	incl. battery inkl. Akku incl. pile
	incl. battery inkl. Batterie incl. pile
	battery specifications Batteriespezifikationen spécifications des piles
	beam angle Ausstrahlwinkel angle de rayonnement
	corner mount possible Eckmontage möglich montage en coin possible
	Colour Rendering Index

	cutout (in mm) Ausschnitt (in mm) perçage du panneau (en mm)
	dimmable with external dimmer dimbar mit externen Dimmer gradable avec un gradateur externe
	not dimmable nicht dimmbar ne pas graduable
	Can be operated via control unit Bedienbar über Steuergerät Peut être commandé par une unité de contrôle
	replaceable LED austauschbare LED LED remplaçables
	loadable in kg belastbar in kg chargeable en kg

	packaging / delivery unit Verpackungs- / Liefereinheit unité d'emballage / de livraison
	shortable kürzbar réductible
	Voltage Volt Voltage
	Watt
	USB connection USB-Anschluss Connexion USB
	Qi-Charger

## PROTECTION CLASS / SCHUTZKLASSE / CLASSE DE PROTECTION

The protection class indicates to what extent the lamp is protected against electric shock. All lamps in this catalogue are at least protected with the protection class 1 - a higher class is specified in the information box of the respective lamp.

Die Schutzklasse gibt an, inwiefern ein Produkt gegen einen elektrischen Schlag gesichert ist. Alle Leuchten in diesem Katalog sind mit mindestens Schutzklasse 1 gesichert, bei höheren Klassen wird das Symbol im Infokasten der Leuchte angegeben.

La classe de protection indique, dans quelle mesure la lampe est protégée contre les chocs électriques. Tous les lampes dans ce catalogue sont protégées au moins avec la classe 1 - une classe plus élevée est indiquée dans l'information de la lampe.

	protection class 1: protective earthing Schutzklasse 1: Schutzerdung classe de protection 1: prise de terre
--	---

	protection class 2: protective insulation Schutzklasse 2: Schutzisolierung classe de protection 2: double isolation ou renforcée
--	--

	protection class 3: protective low voltage Schutzklasse 3: Schutzkleinspannung classe de protection 3: très basse tension de sécurité
--	---

## PROTECTION RATING / SCHUTZGRAD / INDICE DE PROTECTION

The protection rating ensures the operational safety of luminaires. The first number specifies the extent of the protection against the ingress of foreign bodies; the second number identifies the humidity protection grade. All luminaires in this catalogue are at least protected with the rating IP20 - a higher rating is specified in the information box of the luminaire.

Der Schutzgrad gewährleistet die Betriebssicherheit von Leuchten. Die erste Ziffer des IP Grades beschreibt den Schutzzumfang gegen das Eindringen von Fremdkörpern; die zweite Ziffer informiert über den Grad des Feuchtigkeitsschutzes. Alle Leuchten in diesem Katalog sind mit mindestens Schutzgrad IP20 gesichert, bei höheren Graden wird das Symbol im Infokasten der Leuchte angegeben.

L'indice de protection assure la sécurité opérationnelle des luminaires. Le premier chiffre indique à quel point la protection est efficace contre l'insertion de corps étrangers; le second chiffre indique quant à lui le degré de protection par rapport à l'humidité. Tous les luminaires dans ce catalogue sont protégés au moins avec l'indice IP20 - un indice plus élevé est indiqué dans l'information d'article.

	IP33		IP44
--	------	--	------

	IP54		IP65
--	------	--	------

	IP67
--	------

# REGISTER

SERIES NAMES  
SERIENNAMEN  
NOME DE PRODUITS

NAME NAME NOM	PAGE SEITE PAGE	NAME NAME NOM	PAGE SEITE PAGE	NAME NAME NOM	PAGE SEITE PAGE
ABREOSA	232	ARENAZA	803	BELSIANA	476
ACCESS REMOTE	102	ARISCANI	342-343	BELSIANA 1	477
ACOLLA	497	BAJAZZARA	198-199	BENARIBA	525
ACOLLA 1	497	BALIOLA	843	BERREGAS	674
AGLIENTINA	189	BANDERALO	804	BILBANA	790
AGUILARES	332	BANDERILLAS	294-295	BIMEDA	710-713
ALAMEDILLA	294	BANKER	826	BITACHITO	383
ALBANY	445	BARBOTTO	768	BOCADELLA	378
ALBARACCIN	352-353	BARI 1	651	BOCADELLA 1	474
ALBARIZA	184	BARI-M	610	BOLIVIA	414
ALCUDIA	633	BARNHAM	706-707	BOLSANO	362
ALEANDRO 1	360	BARRANCAS	478	BORDONARA	472
ALESSANDRA	445	BASIC	828-829	BORGILLIO	769,824-825
ALMEIDA	191	BASIC 1	828	BOYAL	224-227
ALMEIDA 1	190	BASILANO	322-323	BRENDA	440-442
ALMEIDA 2	186-187	BASILANO 1	320-321	BROLINI	809
ALMERA	561	BASURTU	490	BUCAMARANGA	164
ALMONTE	604	BATABANO	787	BUDENSEA	766
ALOBRASE	335-337,339	BATALLAS	664-665	BUENAVISTA	652
ALTAFLOR	456-458	BATISTA	335	BUENAVISTA 1	654
ALVEZ	447	BATISTA 3	361,785	BUENAVISTA 2	654-655
AMADORA	278	BATTISTONA	524	BUTRANO	399
AMEZAGA	788	BAYA	774	BUZZ-LED	734-739
AMEZOLA	600	BAYA LED	772-773	CABADO	752
AMONTILLADO	394,464	BAYMAN	279	CABADO 1	820
ANCHORENA-Z	22-23	BELESER	346,766	CABALES	818-819
ANDABAIA-Z	27	BELLARIVA	782	CABO	494
ARANZOLA	765	BELLARIVA 3	783	CABO 1	742

NAME NAME NOM	PAGE SEITE PAGE	NAME NAME NOM	PAGE SEITE PAGE	NAME NAME NOM	PAGE SEITE PAGE
CABUS	634-635	CAROVIGNO	682	CORTADERAS	384,765
CADAQUES	340	CARPENTO	324	CORTENOVA	374
CADAQUES 1	340	CARTAMA	371	COSSANO	205-207
CADEGAL	588-589	CARTIGNANO	568	COSSANO 2	208
CAGUANES	430	CASIBARE	234-235,678	COSWARTH	680
CAHUAMA	784	CASIBARE-QI	805	COTORRO	667
CAJERO	820-821	CASTELLATO	790	CREMELLA	236-237
CALAGRANO	541	CASTRALVO	432	CUMIOLE	382
CALAGRANO-Z	37	CAUPO	808	CURASAO	408
CALMANERA	410-411	CAYUCA	717	DAKAR 1	702-703
CALNOVA	635	CEPPINO	814	DAKAR 3	754
CAMACHO	222-223	CERASELLA	355	DAMASCO 1	793-794
CAMASCA	415	CHIETINO 1	780	DAMBERA	816
CAMASTRA	418	CIGLIE	567	DARNIUS	768
CAMBAITO	414	CIVITATE	569	DAVIDA	720-721
CAMBULOS	394	CLAVELLINA	288-289	DAVIDA 1	722-723
CAMINALES-Z	46	CLEMENTE	363,496	DESIERTO	797
CAMPANIA	562	CODRIALES	296-297	DUNDRY	840-841
CAMPILO	424	COGNOLI	810	DURELO	545
CANICOSA 2	504	COLTI	562	DURENGO	816
CANTALLOPS	419	COMPETA 1	527-528	ELGVERO	587
CANTERRAS	230-231	CONCESSA 1	182-183	ELIZONDO	582
CAPASSO	530	CONDRADA 1	494	ELLA	544
CAPASSO 1	518	CONESA	762	ENALURI	370
CAPASSO-Z	55	CONESSA	368-369	ENCINITOS	409,477
CARANACOA	292-293	CONNECT Z	21	ENEA	704-705
CARBONERAS	767	CONNECT-Z SENSOR	21	ERMUA	395,787
CARDILLIO 1	744-745,747	CONSACA	676	ERSEKA	250-251
CARDILLIO 2	746-747	CONTRISA	434	ERVIDEL	286-287
CARDITO	497	CORBERA	728	ESCANDIDOS	244-245
CARDITO 1	364	CORETTO	357	ESPARTAL	763
CARLTON 2	778	CORREDERA	398	ESTAZIONA	761

NAME NAME NOM	PAGE SEITE PAGE	NAME NAME NOM	PAGE SEITE PAGE	NAME NAME NOM	PAGE SEITE PAGE
ESTEPERRA	152,155,669	GERBERA 1	562	LAZOLO	442
ESTEVAU	401	GEXO	818	LEBALIO	333
EXTENTION	845	GIRON	506	LED CARPI	616-617
FABIO	752	GIRON-S	507	LED PALERMO	615
FALICETTO	582	GITA 2	638	LED STRIPE-Z	84-85
FARSALA	345	GOROSIBA	262-263	LEJIAS	300-301
FEDRA 2	365	GOROSIBA 1	262	LIBERTAD	218,220
FELONICHE	575	GRADOLI	380	LIBERTAD 1	219
FERENTINO	522-523	GRADOLI 1	381	LISCIANA	397
FILAGO	430,493	GRAFIK	556	LM_LED_E14	87
FIRMO	827	GUANAL	584	LM_LED_E27	86-97
FLORESTA	406	GURARE	571	LM_LED_GU10	87
FONDACHELLI	760	HAYES	583	LOBATIA	387
FOX	830	HERRORA-Z	60	LOBINERO-Z	26
FRADELO	500-502	IMPERIAL	560	LOCANDA	714
FRADELO 1	498-499	IPOSITTO	464	LOMALTAS-Z	48
FRAIOLI-Z	50-51	ISIDRO	290-291	LONCINO 1	359
FRANIA	508-509,512-513,610,612	JUAREZA-Z	49	LORD 2	444
FRANIA-A	106-107	JUNIOR 1	836	LORETO	491
FRANIA-S	510-511,514-515,611	KOB LED	843	LORETO 1	491
FUEVA 5	618-624,626	LA SECA	807	LOSALOMAS	413
FUEVA-A	112	LACEY-QI	805	LUBERIO	366
FUEVA-Z	68-79	LAGUNITAS	354	LUPPINERIA	539
GAETANO 1	436,438	LANCIANO	520-521	LURONE	246-247
GAFARES	462-463	LANCIANO 1	520-521	MACCACARI	574
GASCUERIA	582	LANCIANO-Z	54	MACCHIONE	481
GATUELA	391	LAROA	812-813	MAGITTA 1	554
GATUELA 1	390	LASANA	306	MAGNUM LED	741
GAZZOLA	416	LASANA 1	302,307	MAGNUM-LED	740-741
GEMILIANA	632	LASANA 2	302-303	MANALBA	781
GENOVESE-Z	33	LASANA 3	304-305	MANALBA 1	781
GEO	795	LAURITO	536	MANILVA 1	612



NAME NAME NOM	PAGE SEITE PAGE	NAME NAME NOM	PAGE SEITE PAGE	NAME NAME NOM	PAGE SEITE PAGE
MANIZALES	381	MIRTAZZA	400	OBREGON	425
MANTUNALLE	348,790	MOGANO	484-485	OILELLA	330-331
MANTUNALLE 1	347	MOGANO 1	438	OKINZURI	401
MANZANARES	252-253	MOGANO 2	487	OLIVAL 1	791
MARASALES	158,160	MONGODIO 1	586	ONEDA	764
MARBELLA	284-285	MONIROTE	457,459	ONO 2	573
MARGHERA-Z	44-45	MONTEBALDO	383,478	OPTICA	258-260
MARGITTA 1	551	MONTEFINO	372	PADROGIANO-Z	38-40
MARIEL	434,493	MONTEFIO	442	PADULARI	460
MARINELLO	467	MONTEFIO 1	366-367	PALBIETA	392
MARINELLO 1	466	MONTEMORELOS-Z	32-33	PALERMO 2	529
MARMORATA	473	MONTENOVO	505	PALMERA	650
MAROJALES	493	MORATICA-A	107	PALMITAL	608-609
MARONDA	191	MORDAZO	479	PALOMARO	128-129
MARS	553,558	MOSIANO	609	PALOMARO 1	128-129
MARS 1	552-553	MULEGES	407	PALOZZA	314-315
MARYVILLA	334,788	MURCIA	280-281	PALOZZA 1	312
MASERLO	166-167,172-174,176-181	MURMILLO	344	PANAGRIA	228-229
MASERLO 1	169-170	MURNIA	786	PANDELLA 1	644-647
MASERLO 2	166,174,177,180	MUSARA	475	PANDELLA 2	644,648
MASETA	404-405	MUSURITA	534-535	PARANDAY-Z	36-37
MASSERIE	802	NADINA	763	PARRAPOS-Z	34-35
MENTALURGIA	542	NARANJO	797	PASCAL 1	561
MESSINARO	476	NARICES	248-249	PASSA	578-581
MESTRE	560-561	NASTASIA	188	PASTERI	122-125,132-139,141-147,777
METRASS	590	NEMO	556	PASTERI SQUARE	126-127
METRASS 1	593	NEVADO	311	PASTORE	130
METRASS 2	591	NIEVES	533	PASTORE 1	130
MEZZANA	378	NIEVES 1	532	PASTORE 2	131
MINI 4	754-755	NOCITO	708-709	PEDREGAL 1	779
MIOGLIA 1	368	NOSINO	761	PENJAMO	540
MIRLAS	468	NUVANO	436-437	PERPIGO	392

NAME NAME NOM	PAGE SEITE PAGE	NAME NAME NOM	PAGE SEITE PAGE	NAME NAME NOM	PAGE SEITE PAGE
PESCAITO	534	ROMAO 3	121	SARRIA	724-727
PETTO 1	787	ROMAO-Z	30-31	SARRIONE	774
PICACHA	767	ROMAZZINA	238-241	SARSINA-A	108
PIEDRITAS	482	ROMENDO 1	628-629	SAVATARILA-Z	56-57
PINETTO	614-615	RONCADE	309,313	SAVOY	282-283
PINTO	272-273	RONCADE 1	308	SCALEA 1	554
PINTO GOLD	270-271	RONDO	254-256	SEGEZIA	416-417
PINTO NERO	268	RONDO 3	256	SELLANO	806
PINTO TEXTIL	266-267	ROTTELO	732-733	SELUCI	536-537
PINTO TEXTIL 1	264	ROVIRA	391	SELVINA	309-310,312
PLANET	546	ROVITO-Z	80-83	SELVINA 1	308
PLANET 1	546-549	RUEDA	846	SELVINO	350-351
POLLICA	672	RUFFO	837	SENDERO	210-211
POSADERRA	126	RUIDERA	517	SERAS	696-697,700-701
POZONDON	505	RUOTALE	397,460	SERAS 1	694-695
POZUETA	377	RUSTICARIA	199	SERAS 2	698-699
RAMON	419	SABINAR	426-427,429	SIBERIA	298-299
RAYA	554	SALICETO-Z	47	SIDERNO	630
RAZONI	402-403	SALITERAS-Z	57	SILENTINA	480-481
REDUCTA 2	543	SALITRE	398	SILERAS	516-517
REKALDE	764	SALOBRENA-A	110-111	SILERAS-A	105
REMIDOS	589	SALOBRENA-Z	64-67	SILERAS-Z	55
RENDE	531	SALOME	558-559	SILVARES	388
RICCIO 1	753	SALTO	748-749	SIMOLARIS-Z	42-43
RIVATO	276-277	SALVILANAS-Z	24-25	SLIM	793
ROCAMAR	356,358	SAMBATELLO	684-685,687	SNAPORA	816
ROCAMAR 1	357-358	SAN PERI	564	SOLO	793
ROCCAFORTE	420-423	SAN PERI 1	601	SOLO 1	792
ROLIMARE	461	SANIA 4	576-577	SOLO 2	791
ROMAGNESE	360	SANIA 5	630-631	SOREGO	718
ROMAO	120-121	SARGINTO	594-595	SORRENTA 1	503
ROMAO 1	120	SARONA	386,788	SPADAFORA	394,464

NAME NAME NOM	PAGE SEITE PAGE	NAME NAME NOM	PAGE SEITE PAGE	NAME NAME NOM	PAGE SEITE PAGE
STAITI	479	TRAGACETE 1	636-637	VILLABATE	671
STAITI 1	564	TREMEDAL	475	VILLABATE 1	776-777
STELLATO 1	200-201	TRONDIO	783	VINCHIO	648
STELLATO 2	201-202	TROY 3	274-275	VINOVO	280
STELLATO 3	203	TRUNCA	802	VISERBELLA	148-150
STICKER	651	TUKON 3	730	VOLTAGO 2	518
SWARBY	785	TURCONA-Z	58,62-63	WASAO 1	609
TABARA	836	TURIALDO	216	ZAMPOTE	465
TABIANO	641	TURIALDO 1	785	ZAMUDILO	516
TABIANO-Z	49	ULISANO	460	ZAPATA	693
TABILLANO	688	UP 2	770-771	ZAPATA 1	690
TABILLANO 1	822	VADUMI	642	ZARAGOZA	162-163
TAMARA 1	602-603	VALBIANO	670	ZERACO	731
TAMURIA	470	VALCASOTTO	488,538	ZILLERIO-Z	26
TANURA	584	VALCASOTTO 1	489	ZINACUA	571
TARANDELL	307	VALDELAGRANO-Z	42	ZOCABON	406
TAREGA	389,783	VALDIOLA	412	ZOLA	650
TARRAFO	431,489	VALLASPRA	361	ZUBIALDE	572-573
TAZZOLI	567	VALLEMARE	503	ZUBIETA-A	102-104
TELIBELA-Z	28-29	VALMORA	310-311		
TEYA	842	VARILLAS	157		
TIMPAROSSA	570	VARRAZO	365		
TINDORI	204-205	VELASCO	196-197		
TINEO	753	VENEZUELA	242-243		
TIRRENARA	466	VERADAL	814-815		
TOLLOS-Z	30	VERADAL-QI	805		
TOLORICO	606	VERDELLO	632-633		
TORONA 1	822	VERGIANO	719		
TORRETTA	635	VETRO	446-447		
TORRONTES	340	VIGLIONI	431		
TOTARI-Z	33,52-53	VIKI 1	837		
TOWNSHEND 3	660-663	VILANOVA	742-743		

# REGISTER

ARTICLE NUMBER  
ARTIKELNUMMER  
NUMÉROS D'ARTICLE

NUMBER NUMMER NUMÉRO	PAGE SEITE PAGE	NUMBER NUMMER NUMÉRO	PAGE SEITE PAGE	NUMBER NUMMER NUMÉRO	PAGE SEITE PAGE	NUMBER NUMMER NUMÉRO	PAGE SEITE PAGE	NUMBER NUMMER NUMÉRO	PAGE SEITE PAGE	NUMBER NUMMER NUMÉRO	PAGE SEITE PAGE
12221	92	12257	96	31581	132	31667	365	33682	616	81636	544
12222	92	12258	97	31582	136	31995	309	33941	588	81827	795
12223	92	3041	446	31586	136	31996	309	33942	589	81828	795
12224	93	30658	588	31588	143	31997	313	33964	589	82305	793
12225	93	30659	588	31589	132	32025	497	33984	262	82741	560
12226	88	30832	722	31592	136	32048	306	39092	322	82747	283
12227	88	30833	723	31594	145	32428	736	39093	323	82748	282
12228	88	30834	723	31595	135	32429	736	39094	323	82749	282
12229	89	30835	723	31596	139	32431	736	39095	322	82751	283
12231	89	30931	494	31599	173	32432	737	39099	320	82752	283
12232	89	30933	494	31601	166	32433	737	39101	320	82785	446
12233	90	31001	710	31602	177	32765	690	39102	321	82786	446
12234	90	31002	711	31603	179	32766	690	39103	320	82842	770
12235	90	31003	710	31605	173	32767	690	39113	324	82843	770
12236	91	31004	710	31606	166	33168	661	39114	324	82844	771
12237	91	31005	712	31607	176	33169	660	39836	294	82942	546
12239	91	31006	713	31608	180	33171	660	39838	294	83119	556
12241	94	31007	713	31611	172	33172	660	39839	295	83132	556
12242	94	31008	713	31613	177	33184	738	43637	485	83153	547
12243	94	31571	143	31614	179	33185	738	7184	558	83154	547
12244	95	31572	132	31616	172	33186	738	7186	558	83155	546
12245	95	31573	137	31618	176	33187	739	7188	559	83156	547
12251	87	31574	141	31619	179	33199	102	80263	553	83157	548
12252	87	31575	142	31627	174	33344	422	80264	553	83159	548
12253	86	31576	133	31628	167	33345	420	80265	558	83162	548
12254	87	31577	137	31629	178	3355	445	81262	752	83163	549
12255	96	31578	141	31631	180	33677	603	81265	752	83404	544
12256	96	31579	142	31666	441	33678	603	81635	544	83406	650



NUMBER NUMMER NUMÉRO	PAGE SEITE PAGE	NUMBER NUMMER NUMÉRO	PAGE SEITE PAGE	NUMBER NUMMER NUMÉRO	PAGE SEITE PAGE	NUMBER NUMMER NUMÉRO	PAGE SEITE PAGE	NUMBER NUMMER NUMÉRO	PAGE SEITE PAGE	NUMBER NUMMER NUMÉRO	PAGE SEITE PAGE
84028	556	87055	441	900022	57	900079	50	900128	55	900172	701
85104	792	87219	650	900023	57	900081	50	900129	55	900173	700
85261	254	87222	650	900024	57	900082	50	900134	765	900174	397
85262	254	87254	792	900025	56	900083	54	900135	765	900175	397
85263	255	87256	792	900044	64	900084	52	900141	791	900176	247
85264	255	87284	836	900045	64	900085	53	900142	791	900177	246
85832	651	87793	561	900046	64	900086	80	900143	414	900178	247
85856	284	88472	702	900047	65	900087	81	900144	162	900179	247
85857	284	88473	702	900048	65	900088	80	900145	162	900185	493
85858	285	88474	703	900049	66	900089	80	900146	162	900186	430
85859	284	88475	703	900051	66	900091	83	900147	163	900187	760
85971	774	88968	845	900052	66	900092	82	900148	163	900188	491
85974	774	88969	845	900053	67	900093	82	900149	530	900195	332
85977	274	89115	561	900054	58	900094	82	900151	196	900196	332
85978	274	89238	553	900055	58	900095	67	900152	196	900302	478
85979	274	89239	552	900056	58	900099	68	900153	196	900304	253
85981	275	89248	552	900057	62	900101	68	900154	197	900305	252
85982	275	89758	554	900058	62	900102	68	900157	491	900306	253
86712	560	89832	272	900059	62	900103	74	900158	415	900307	253
86715	561	89833	273	900061	63	900104	74	900159	415	900313	432
86811	258	89834	272	900062	63	900105	72	900161	426	900314	786
86812	258	89835	272	900067	44	900106	72	900162	426	900315	36
86813	260	89836	273	900068	44	900107	73	900163	426	900316	36
86814	260	900001	52	900069	44	900108	78	900164	236	900317	36
86815	260	900002	52	900071	45	900109	79	900165	242	900318	37
86816	258	900005	54	900072	45	900111	70	900166	242	900319	35
86817	259	900006	54	900075	42	900112	70	900167	242	900321	35
87008	444	900008	55	900076	51	900113	70	900168	243	900322	34
87009	444	900019	49	900077	51	900114	76	900169	700	900323	34
87054	442	900021	49	900078	51	900115	76	900171	700	900324	34

NUMBER NUMMER NUMÉRO	PAGE SEITE PAGE	NUMBER NUMMER NUMÉRO	PAGE SEITE PAGE	NUMBER NUMMER NUMÉRO	PAGE SEITE PAGE	NUMBER NUMMER NUMÉRO	PAGE SEITE PAGE	NUMBER NUMMER NUMÉRO	PAGE SEITE PAGE	NUMBER NUMMER NUMÉRO	PAGE SEITE PAGE
900325	573	900363	611	900404	27	900446	430	900495	238	900529	809
900328	465	900364	611	900406	30	900463	539	900496	240	900549	334
900329	465	900365	615	900407	30	900464	539	900497	241	900551	334
900331	718	900366	614	900408	32	900465	298	900498	532	900552	788
900332	718	900367	476	900409	32	900466	298	900499	532	900553	487
900333	718	900369	617	900411	32	900467	298	900501	532	900554	487
900334	785	900375	583	900412	33	900468	299	900502	198	900555	487
900335	530	900376	189	900419	461	900469	299	900503	198	900558	473
900336	28	900377	189	900421	462	900471	460	900504	198	900559	473
900337	28	900378	189	900422	463	900472	397	900505	199	900561	473
900338	28	900379	434	900423	463	900475	632	900506	335	900562	293
900339	29	900381	434	900424	463	900476	633	900507	335	900563	292
900341	264	900382	687	900425	414	900477	33	900508	335	900564	293
900342	264	900383	687	900426	414	900478	26	900509	481	900565	293
900343	584	900384	687	900428	601	900479	26	900511	256	900566	37
900346	416	900385	199	900429	412	90048	278	900512	256	900567	37
900347	188	900386	199	90043	554	900481	38	900513	746	900571	472
900348	188	900387	22	900431	412	900482	40	900514	747	900572	472
900349	219	900388	22	900432	667	900483	38	900515	747	900573	472
900351	288	900391	22	900433	667	900484	38	900516	746	900596	460
900352	288	900392	23	900434	667	900485	40	900517	584	900597	460
900353	288	900393	764	900435	489	900486	39	900518	584	900598	521
900354	289	900394	764	900436	717	900487	39	900519	238	900599	521
900355	482	900395	256	900437	717	900488	228	900521	241	900601	541
900356	482	900396	787	900438	717	900489	228	900522	239	900602	541
900357	482	900398	26	900439	30	90049	278	900523	241	900603	466
900358	790	900399	382	900441	31	900491	228	900524	479	900604	466
900359	484	900401	386	900442	31	900492	229	900525	570	900605	524
900361	493	900402	386	900443	489	900493	229	900526	570	900606	524
900362	434	900403	788	900444	431	900494	238	900528	809	900607	522

NUMBER NUMMER NUMÉRO	PAGE SEITE PAGE	NUMBER NUMMER NUMÉRO	PAGE SEITE PAGE	NUMBER NUMMER NUMÉRO	PAGE SEITE PAGE	NUMBER NUMMER NUMÉRO	PAGE SEITE PAGE	NUMBER NUMMER NUMÉRO	PAGE SEITE PAGE	NUMBER NUMMER NUMÉRO	PAGE SEITE PAGE
900608	522	90917	733	92288	845	93046	783	93877	772	94592	358
900609	523	90927	733	9229	828	93073	366	93901	806	94593	358
900611	523	90967	826	9230	829	93076	818	93917	770	94605	438
900612	531	90977	828	9232	829	93077	818	93949	129	94606	438
900613	531	90978	445	92348	846	93078	816	93952	129	94609	742
900614	491	90982	705	92563	279	93085	742	93965	808	94612	641
900615	632	90984	704	92595	734	93092	365	93966	808	94613	641
900616	632	90985	704	92596	734	93358	743	94145	730	94614	641
900617	633	90986	704	92597	734	93359	742	94146	730	94617	635
900618	633	91002	280	92598	735	93373	424	94244	371	94626	609
900619	611	91004	280	92599	735	93374	424	94245	371	94635	206
900626	805	91005	281	92641	740	93395	128	94251	714	94636	206
900628	805	91006	281	92642	740	93397	128	94252	714	94673	816
900631	296	91238	793	92643	740	93468	442	94319	360	94677	816
900632	296	91242	795	92644	741	93625	364	94329	753	94686	843
900633	297	91433	280	92645	741	93626	364	94377	359	94697	824
900634	164	91496	442	92727	494	93672	728	94378	359	94698	769
900635	164	91589	255	92739	276	93673	728	94388	403	94699	824
900636	33	91971	279	92741	277	93674	728	94389	403	94702	824
900839	747	92084	720	92742	277	93679	731	94438	205	94704	825
90304	268	92085	720	92743	277	93706	843	94442	205	94705	769
90305	268	92086	720	92761	362	93707	843	94513	787	94712	638
90697	562	92087	721	92762	362	93708	367	94547	484	94713	638
90737	562	92143	562	92872	830	93709	366	94548	484	94714	638
90872	827	92146	837	92873	830	93713	774	94584	707	94716	635
90873	827	92147	837	92924	754	93784	367	94585	706	94764	207
90874	827	92206	763	92925	754	93836	357	94586	706	94765	207
90914	732	92251	402	92933	755	93874	773	94587	706	94767	207
90915	732	92252	403	92935	754	93875	772	94589	356	94878	604
90916	732	9228	828	93003	273	93876	772	94591	356	94879	604

NUMBER NUMMER NUMÉRO	PAGE SEITE PAGE	NUMBER NUMMER NUMÉRO	PAGE SEITE PAGE	NUMBER NUMMER NUMÉRO	PAGE SEITE PAGE	NUMBER NUMMER NUMÉRO	PAGE SEITE PAGE	NUMBER NUMMER NUMÉRO	PAGE SEITE PAGE	NUMBER NUMMER NUMÉRO	PAGE SEITE PAGE
94884	609	95147	306	95483	708	95632	749	95912	369	96104	302
94918	143	95164	145	95484	709	95639	497	95913	368	96105	303
94919	134	95166	139	95485	708	95655	500	95914	369	96106	303
94921	137	95167	135	95522	388	95656	500	95972	518	96111	551
94924	144	95169	174	95523	388	95657	501	95973	518	96117	551
94925	134	95171	178	95525	389	95658	501	95993	602	96178	744
94926	138	95172	181	95526	389	95659	501	95994	602	96179	744
94935	436	95173	167	95527	783	95661	500	95995	602	96181	745
94936	436	95185	779	95539	760	95662	502	96023	530	96182	744
94938	438	95192	191	95541	760	95664	502	96026	518	96183	745
94958	725	95194	191	95545	693	95672	554	96032	528	96193	210
94959	725	95254	208	95546	693	95677	527	96033	528	96194	210
94961	725	95257	208	95547	693	95679	527	96034	528	96195	210
94962	724	95261	208	95567	307	95682	529	96037	590	96199	211
94963	726	95282	616	95568	307	95684	529	96038	590	96201	211
94964	726	95283	617	95569	302	95686	762	96039	593	96211	204
94965	727	95284	496	95589	203	95689	503	96041	593	96214	205
94966	726	95285	496	95591	203	95694	821	96042	591	96229	612
94967	616	95286	363	95594	203	95695	820	96043	591	96231	612
94973	545	95287	363	95597	201	95696	820	96048	573	96257	204
94987	651	95364	580	95598	200	95725	777	96049	573	96258	204
94995	191	95368	579	95599	200	95726	777	96064	646	96261	578
94998	615	95371	580	95602	200	95755	436	96065	646	96264	579
94999	615	95373	581	95605	202	95775	794	96066	646	96305	311
95044	146	95377	579	95606	201	95776	794	96072	447	96306	312
95045	146	95379	580	95607	201	95785	793	96073	447	96308	310
95055	178	95383	425	95609	202	95787	778	96081	842	96326	310
95118	144	95385	425	95628	749	95788	778	96089	551	96327	310
95119	139	95386	781	95629	748	95789	778	96102	302	96329	309
95122	135	95482	708	95631	749	95824	741	96103	303	96331	311



NUMBER NUMMER NUMÉRO	PAGE SEITE PAGE	NUMBER NUMMER NUMÉRO	PAGE SEITE PAGE	NUMBER NUMMER NUMÉRO	PAGE SEITE PAGE	NUMBER NUMMER NUMÉRO	PAGE SEITE PAGE	NUMBER NUMMER NUMÉRO	PAGE SEITE PAGE	NUMBER NUMMER NUMÉRO	PAGE SEITE PAGE
96332	311	96773	344	97367	372	97605	384	97718	630	97876	512
96343	345	96774	344	97368	372	97606	384	97719	630	97877	510
96344	345	96866	307	97479	130	97611	122	97731	478	97878	510
96345	345	96937	635	97487	503	97612	125	97733	383	97879	510
96434	812	96938	634	97506	719	97613	123	97734	383	97881	514
96435	813	96957	822	97507	719	97614	124	97737	521	97882	514
96436	813	96981	427	97508	719	97615	122	97738	520	97883	514
96437	812	96982	427	97516	780	97616	125	97773	782	97884	610
96438	812	96983	427	97526	506	97617	123	97774	782	97885	612
96439	813	96985	429	97527	506	97618	124	97777	120	97886	564
96474	447	96986	429	97528	506	97619	122	97778	121	97895	479
96477	144	97044	807	97531	610	97621	125	97779	120	97904	479
96478	134	97045	807	97536	670	97622	123	97782	120	97914	810
96479	138	97054	606	97537	670	97641	148	97783	121	97915	810
96481	141	97055	606	97538	670	97642	149	97784	121	97934	753
96483	147	97056	606	97541	507	97643	148	97793	361	97965	608
96484	147	97059	648	97542	507	97644	148	97806	765	97966	609
96528	360	97066	401	97543	507	97645	150	97838	130	98016	380
96538	128	97077	752	97571	841	97646	150	97839	270	98017	380
96539	129	97078	820	97572	840	97647	150	97841	420	98023	505
96541	628	97081	642	97573	840	97651	270	97845	420	98034	476
96542	628	97082	642	97574	840	97652	271	97846	421	98035	476
96543	629	97083	642	97575	837	97653	270	97854	423	98056	374
96544	628	97209	791	97577	516	97655	271	97855	423	98057	374
96552	696	97333	790	97578	517	97667	836	97857	423	98058	374
96553	697	97361	314	97583	768	97682	183	97871	508	98071	418
96554	697	97362	314	97584	768	97683	183	97872	508	98093	802
96555	697	97363	314	97587	361	97684	182	97873	508	98111	663
96566	567	97364	315	97589	785	97685	182	97874	512	98112	662
96567	567	97366	372	97604	384	97699	604	97875	512	98113	662

NUMBER NUMMER NUMÉRO	PAGE SEITE PAGE	NUMBER NUMMER NUMÉRO	PAGE SEITE PAGE	NUMBER NUMMER NUMÉRO	PAGE SEITE PAGE	NUMBER NUMMER NUMÉRO	PAGE SEITE PAGE	NUMBER NUMMER NUMÉRO	PAGE SEITE PAGE	NUMBER NUMMER NUMÉRO	PAGE SEITE PAGE
98114	662	98309	763	98409	130	98543	574	98651	342	98754	263
98134	684	98311	157	98421	576	98544	575	98652	342	98755	582
98135	684	98313	157	98422	576	98545	575	98653	343	98759	582
98136	685	98314	157	98423	576	98582	340	98654	343	98762	688
98137	684	98317	474	98424	577	98585	340	98656	586	98763	688
98139	671	98318	474	98425	577	98587	190	98657	586	98764	688
98141	671	98319	474	98426	577	98588	190	98661	377	98831	815
98201	111	98323	520	98446	509	98591	432	98662	377	98832	814
98203	111	98324	520	98447	513	98592	432	98663	377	98834	381
98205	110	98325	533	98448	511	98595	357	98674	764	98835	381
98206	110	98326	533	98449	515	98596	358	98676	587	98836	395
98207	108	98331	480	98456	419	98601	535	98677	645	98837	787
98208	108	98332	480	98458	768	98602	535	98678	370	98838	413
98209	108	98333	480	98487	505	98603	534	98679	475	98839	413
98212	112	98334	481	98488	505	98604	535	98682	392	98841	571
98219	107	98346	378	98491	464	98614	336	98683	392	98842	69
98227	105	98347	378	98492	394	98615	336	98685	504	98843	75
98228	105	98353	419	98494	464	98616	336	98687	391	98844	71
98235	107	98379	582	98495	394	98617	337	98688	401	98845	76
98236	106	98384	346	98501	648	98621	682	98689	401	98846	72
98237	106	98386	766	98502	648	98622	682	98694	350	98847	78
98247	802	98387	766	98507	475	98623	682	98695	350	98849	74
98263	567	98393	694	98514	493	98624	672	98696	350	98852	77
98277	846	98394	694	98523	352	98625	672	98697	351	98854	78
98279	846	98395	695	98524	352	98626	672	98698	351	98855	814
98291	340	98396	694	98525	353	98628	368	98699	351	98856	814
98292	112	98397	699	98526	352	98629	368	98734	440	98858	383
98293	112	98398	698	98527	504	98647	339	98735	440	98859	785
98294	106	98399	699	98541	574	98648	339	98752	263	98861	468
98297	110	98408	699	98542	574	98649	339	98753	263	98862	468

NUMBER NUMMER NUMÉRO	PAGE SEITE PAGE	NUMBER NUMMER NUMÉRO	PAGE SEITE PAGE	NUMBER NUMMER NUMÉRO	PAGE SEITE PAGE	NUMBER NUMMER NUMÉRO	PAGE SEITE PAGE	NUMBER NUMMER NUMÉRO	PAGE SEITE PAGE	NUMBER NUMMER NUMÉRO	PAGE SEITE PAGE
98863	468	99052	674	99113	766	99279	155	99339	637	99446	184
98864	788	99053	674	99122	600	99286	266	99341	516	99447	184
98874	286	99054	674	99123	600	99287	267	99342	516	99457	225
98875	286	99072	400	99124	600	99288	266	99343	525	99463	390
98876	286	99073	400	99202	618	99292	222	99344	525	99464	390
98877	287	99074	680	99203	618	99293	222	99345	236	99465	525
98878	287	99075	680	99204	621	99294	222	99346	236	99466	227
98881	477	99076	680	99205	620	99295	223	99347	237	99467	226
98882	477	99077	216	99206	618	99296	223	99348	564	99468	226
98887	794	99078	216	99207	619	99297	647	99353	225	99469	227
98888	590	99079	216	99208	620	99298	126	99356	497	99486	186
98889	312	99086	572	99209	620	99314	333	99358	296	99487	186
98891	104	99087	572	99211	623	99315	304	99366	348	99488	664
98892	104	99089	126	99212	622	99316	304	99367	348	99489	664
98893	104	99091	127	99213	622	99317	304	99368	348	99491	664
98894	102	99092	127	99214	622	99318	305	99369	790	99492	665
98895	102	99093	251	99249	398	99319	305	99371	347	99506	237
98896	103	99094	251	99265	624	99321	308	99372	347	99507	237
98907	644	99095	251	99266	624	99322	308	99395	461	99508	131
98908	644	99096	250	99267	624	99323	308	99397	542	99509	131
98909	378	99097	250	99268	626	99324	498	99398	542	99511	232
99013	392	99098	250	99269	626	99325	498	99399	543	99512	232
99015	761	99099	21	99271	626	99326	499	99406	534	99513	232
99019	822	99101	761	99272	152	99327	499	99407	534	99514	488
99041	170	99103	776	99273	152	99328	498	99408	225	99515	488
99042	169	99104	777	99274	152	99329	781	99413	224	99516	488
99043	169	99106	21	99275	155	99331	781	99429	294	99517	678
99044	169	99107	370	99276	669	99332	783	99438	416	99518	678
99045	170	99108	517	99277	669	99334	818	99439	417	99519	678
99046	170	99109	517	99278	669	99335	819	99445	184	99523	160

NUMBER NUMMER NUMÉRO	PAGE SEITE PAGE	NUMBER NUMMER NUMÉRO	PAGE SEITE PAGE	NUMBER NUMMER NUMÉRO	PAGE SEITE PAGE	NUMBER NUMMER NUMÉRO	PAGE SEITE PAGE	NUMBER NUMMER NUMÉRO	PAGE SEITE PAGE	NUMBER NUMMER NUMÉRO	PAGE SEITE PAGE
99524	158	99594	249	99631	262	99682	25	99774	652	99808	245
99525	158	99595	568	99632	262	99683	25	99776	636	99809	244
99526	160	99596	569	99633	405	99684	84	99777	636	99811	381
99527	160	99597	797	99634	404	99685	85	99778	636	99817	464
99531	387	99599	394	99635	404	99686	84	99779	536	99818	398
99532	387	99601	42	99636	404	99687	84	99781	537	99819	391
99539	174	99602	43	99639	60	99689	571	99782	536	99821	391
99541	177	99603	42	99651	354	99691	631	99783	536	99822	767
99542	180	99604	43	99654	354	99692	630	99784	458	99824	784
99543	166	99605	43	99655	470	99693	410	99785	458	99825	784
99544	230	99606	594	99656	470	99694	410	99786	458	99828	803
99545	230	99607	594	99659	467	99695	411	99787	457	99829	803
99546	231	99608	595	99661	408	99696	411	99788	456	99831	804
99547	231	99609	595	99662	408	99697	399	99789	457	99832	804
99548	60	99611	187	99663	437	99698	399	99791	459	99838	654
99549	60	99612	186	99664	477	99699	533	99792	457	99839	654
99551	234	99613	158	99665	409	99701	431	99793	466	99853	654
99552	234	99614	330	99666	409	99702	431	99794	797	99854	655
99553	234	99615	330	99667	490	99703	540	99795	218	99855	218
99554	235	99616	330	99669	47	99704	540	99796	220	99856	218
99555	235	99617	331	99671	47	99705	406	99797	220		
99559	312	99618	407	99672	47	99706	406	99798	220		
99561	291	99619	407	99673	46	99707	406	99799	300		
99562	290	99621	538	99674	46	99711	676	99801	300		
99563	291	99622	538	99675	46	99712	676	99802	300		
99564	291	99623	538	99676	48	99713	676	99803	301		
99588	49	99624	224	99677	48	99715	767	99804	301		
99591	249	99625	226	99678	24	99731	644	99805	301		
99592	248	99628	355	99679	24	99772	652	99806	244		
99593	249	99629	355	99681	24	99773	652	99807	244		





All previous catalogues and price lists are no longer valid with the issue of this catalogue. Errors, misprints, model and price changes and technical modifications are reserved. We deliver based on our terms of delivery and payment. Our products comply with the European light norm EN60598. Products with the ENEC test mark are conforming to the guide line 2006/95/EG. Products with additional safety remarks (e.g protection class, IP) are identified within the product family with the relevant symbol and number. The content of this catalogue is protected under copyright law for EGLO Leuchten GmbH. All rights reserved. Our specific written consent must be obtained before using any illustrations and texts. The pictures are 4C prints and may differ from the original. The product pictures and ambiances in this catalogue can deviate from reality, and they do not necessarily concur with the usual application of the product. EGLO does not assume liability for the correctness, completeness or the application depiction of the products and/or the product information. Design, layout and composition: EGLO GmbH, A-6136 Pill - AUSTRIA Print: Samson Druck GmbH, 5581 St. Margarethen - AUSTRIA Pictures: EGLO, Adobe Stock, istockphoto.com

---

Mit diesem Katalog verlieren alle vorhergehenden Kataloge und Preislisten ihre Gültigkeit. Irrtümer, Druckfehler, Modell- und Preisänderungen sowie technische Änderungen vorbehalten. Wir liefern zu unseren Liefer- und Zahlungsbedingungen. Unsere Produkte entsprechen der europäischen Leuchtnorm EN 60598. Produkte mit dem ENEC Prüfzeichen sind konform mit der Richtlinie 2006/95/EG. Produkte mit weiteren Sicherheitshinweisen (zB. Schutzklasse, IP) sind mit Symbol und Zahl bei der Produktfamilie ausgezeichnet. Der Inhalt dieses Kataloges ist für die EGLO Leuchten GmbH urheberrechtlich geschützt. Alle Rechte sind vorbehalten. Bilder und Texte dürfen nicht ohne vorherige ausdrückliche, schriftliche Genehmigung verwendet werden. Die Abbildungen sind 4C Drucke und können vom Original abweichen. Die Katalogbilder und die gezeigten Darstellungen der Produkte können von der Wirklichkeit abweichen und nicht den üblichen Produktanwendungen entsprechen. EGLO übernimmt keine Haftung für die Richtigkeit, Vollständigkeit und Anwendungsdarstellung der Produkte und Produktinformationen. Gestaltung, Layout und Satz: EGLO GmbH, A-6136 Pill - AUSTRIA Druck: Samson Druck GmbH, 5581 St. Margarethen - AUSTRIA Bilder: EGLO, Adobe Stock, istockphoto.com

---

Le présent catalogue remplace tous les catalogues et tarifs précédents. Sous réserve d'erreurs, de fautes d'impression, de modification des modèles et de changement de prix et de technique. Nous livrons sur la base de nos conditions de livraison et de paiement. Nos produits sont conformes aux normes européennes EN 60598 et portent le marquage CE. Les produits portant la marque ENEC sont conformes à la Directive 2006/95/EG. Les produits portant d'autres indications de sécurité (par exemple classe de protection, IP) sont identifiés par le symbole et le nombre correspondants dans la famille de produits. Le contenu du présent catalogue est protégé pour la société EGLO Leuchten GmbH par un copyright. Tous droits réservés. Toute reproduction d'images et du texte est interdite sans autorisation explicite par écrit préalable. Les images sont imprimées en 4C et peuvent différer de l'original. Les images des produits et les ambiances dans le catalogue peuvent dévier de la réalité et ne sont pas nécessairement en ligne avec l'usage habituel du produit. EGLO n'engage pas sa responsabilité sur la justesse des images et sur les informations relatives à l'usage pouvant être fait des produits. Conception, maquette et composition: EGLO GmbH, A-6136 Pill - AUSTRIA Presse: Samson Druck GmbH, 5581 St. Margarethen - AUSTRIA Images: EGLO, Adobe Stock, istockphoto.com

07-2022





**EGLO**  
my light | my style

EGLO Leuchten GmbH  
Heiligkreuz 22  
A-6136 Pill  
Austria  
Tel. +43 (0) 5242 6996  
Fax +43 (0) 5242 6996-972  
info@eglo.com  
www.eglo.com

KAT-22



my light | my style